

AXIS WAKE

TENNESSEE
5075 Kimberly Way
Loudon, TN 37774
(865) 458-5478

AUSTRALIA
813 Hope Court
Albury, N.S.W. 2640
(02) 6040-1174



2024
Owner's Manual

 **WARNING**

Operating, servicing, and maintaining a recreational marine vessel can expose you to chemicals including engine exhaust, carbon monoxide, phthalates, and lead, which are known to the State of California to cause cancer and birth defects or other reproductive harm. To minimize exposure, avoid breathing exhaust, service your vessel in a well-ventilated area, and wear gloves or wash your hands frequently when servicing this vessel. For more information, go to www.P65warnings.ca.gov/marine.

introduction



Welcome!

Congratulations on your purchase of a new high-performance recreational tow boat! Your new Axis Boat has been constructed to meet and/or exceed all U.S. Coast Guard and National Marine Manufacturers Association requirements at the time of its manufacture. However, it is still your responsibility as the boat owner to ensure the boat is operated in a safe manner and is properly maintained.

Prior to operating the boat for the first time, you must carefully read and familiarize yourself with this Owner's Manual and all on-product safety labels. You must also agree to comply with federal, state, and local boating regulations.

The manual contains important information on boating safety, boating rules, proper operation, and maintenance of your boat. This manual provides a guideline for proper operation and maintenance of your boat, and you should consider it a permanent part of your vessel. If this boat is sold, this manual should be included along with the boat to ensure that it will provide the same important information to the next owner.

Axis Boats will use updates to its website (www.axiswake.com) and direct mail contact to make every reasonable effort to apprise you of information you will need to enjoy long-term and highly satisfactory use of your boat.



About Your New Boat

Axis is proud to provide you with the most exciting, cutting-edge technology available in the towing boat industry. The boat you have purchased represents the state of the art at the time of manufacture.

As you can expect from the industry's leader since 1982, Axis expands and innovates continually. As a result, updated product or specifications may be introduced during any given model year. Axis reserves the right to introduce new product or changes to existing model lines without notification or incurring responsibility to make the same changes to boats in the market completed prior to the date of change.

Axis strongly recommends reading any and all additional information provided by component manufacturers and supplied with the boat at time of purchase. Also check out websites for Axis and its component manufacturers periodically to stay abreast of any changes, updates, service bulletins, and general information. Axis will use these various methods of communication, from this manual and including, but not limited to, direct mail contact and website updates, to make every reasonable effort to apprise you of the information you will need to continue long-term and highly satisfactory use of your boat.

About This Owner's Manual

This Owner's Manual has been compiled to address as many potential issues and questions as may arise, in addition to explaining how to operate the boat and its systems correctly and safely as possible to ensure long-term and enjoyable use. However, Axis cannot anticipate every potential situation that can arise, affecting the care and protection of your boat, nor every circumstance that could arise in the operation or care of the boat when not in use.

Axis Boats strongly recommends reading any and all additional information provided by component manufacturers and supplied with the boat at time of purchase. Also, visit Axis Boats' and its component manufacturers' websites periodically to stay abreast of any changes, updates, service bulletins, and general information.

The recommended practices and warning in this manual represent sound advice for recreational boating and identify common risks encountered by boaters engaging in towed watersport activities.

Read and understand the content of this manual. Ask questions of a boating professional if anything in this manual does not make sense to you. The manual does not cover all instances of risk or danger, so please use common sense and good judgment when boating. If you follow the advice provided in this manual you will significantly reduce risk to yourself, your passengers, towed participants, and other boaters.

This manual is not intended to be a substitute for taking a course on boating safety nor is it a substitute for boating experience. It is recommended that if you are unfamiliar with the use and operation of a boat that you seek advice and training from a qualified individual or organization. Check with your local marine law enforcement agency or dealer for more information about boating safety classes in your area.

The precautions listed in this manual and on the boat are not all-inclusive. If a procedure or method is not specifically recommended, you must be satisfied that it is safe for you and your passengers, and that the boat will not be damaged or made unsafe as a result of your decision. Remember, always use caution and common sense when operating and maintaining your boat!

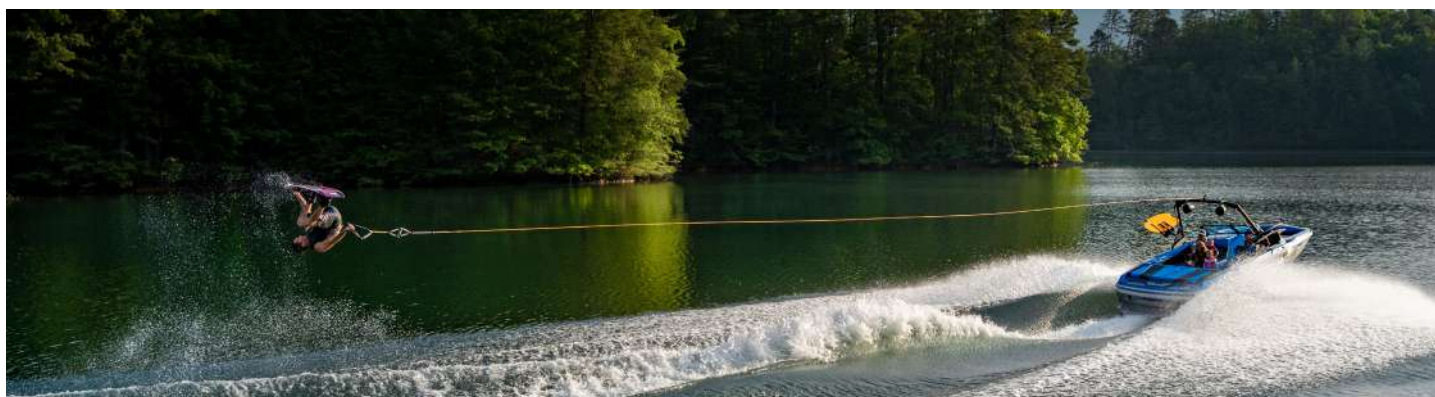

table of contents

SAFETY	1
<i>Embracing Safety</i>	1
<i>Owner Responsibility And Boating Education</i>	4
<i>Safety And Required Equipment</i>	6
<i>General Boating Safety Topics</i>	10
<i>On-Product Warning Labels</i>	16
<i>Basic Rules Of The Road</i>	18
<i>Watersports Safety</i>	23
<i>Emergency Procedures</i>	27
QUICK REFERENCE GUIDE	31
A20.....	32
A225.....	33
A245.....	34
T220.....	35
T235.....	36
T250.....	37
DASHES AND VIDEO SCREENS	38
<i>Accessory Keypads</i>	42
<i>Basic Electrical Components</i>	44
<i>Other Electrical Components</i>	48
<i>Electrical Systems</i>	49
ENGINES AND POWERTRAINS	54
<i>Axis Monsoon Engines, Transmissions, And V-Drives</i>	54
<i>General Information</i>	55
<i>California Emissions Information</i>	57
<i>Monsoon Engine Support Systems</i>	60
<i>Break-In Period—Boats</i>	67
<i>Transmissions And V-Drives</i>	68
HOW IT WORKS	70
<i>Safety First</i>	70
<i>Interior Performance</i>	75
<i>Interior Luxury</i>	76
<i>Tower, Canvas, And Accessories</i>	80
<i>On And Under The Water</i>	83
<i>Underwater Gear</i>	89
<i>Saltwater Series</i>	91
TRAILERS	93
<i>Reporting Safety Defects</i>	93



<i>Connection To The Tow Vehicle</i>	<i>94</i>
<i>How To Connect To The Tow Vehicle</i>	<i>96</i>
<i>Connecting To The Boat</i>	<i>97</i>
<i>Trailer Components And How They Function.....</i>	<i>98</i>
<i>Additional Options.....</i>	<i>107</i>
<i>Towing Advice</i>	<i>108</i>
<i>Launching And Reloading The Boat From The Trailer</i>	<i>109</i>
GET READY.....	111
<i>Axis Fuel System</i>	<i>111</i>
<i>Operations.....</i>	<i>112</i>
<i>Starting And Operation.....</i>	<i>112</i>
<i>Starting The Engine.....</i>	<i>112</i>
<i>To Turn Off.....</i>	<i>113</i>
<i>Break-In Period</i>	<i>113</i>
<i>Smart Operations.....</i>	<i>114</i>
<i>Stopping.....</i>	<i>114</i>
<i>High Speed Maneuvers.....</i>	<i>114</i>
<i>Special Conditions.....</i>	<i>115</i>
<i>Towing And Interaction.....</i>	<i>115</i>
<i>Anchoring.....</i>	<i>115</i>
<i>Docking And Tie-Up.....</i>	<i>115</i>
<i>Aquatic Invasive Species</i>	<i>116</i>
CARE AND MAINTENANCE.....	119
<i>On-Going Care.....</i>	<i>119</i>
<i>Approved Cleaners For Axis Upholstery (Except Cool Tech*).....</i>	<i>122</i>
<i>Additional Routine Care.....</i>	<i>123</i>
<i>Saltwater Care And Maintenance.....</i>	<i>124</i>
<i>Routine Maintenance.....</i>	<i>127</i>
<i>Before Starting The Engine</i>	<i>128</i>
<i>After Starting The Engine</i>	<i>131</i>
<i>After The Outing.....</i>	<i>131</i>
<i>After 10 Hours On The Hourmeter Have The Engine Oil Changed By An Authorized Axis Dealer</i>	<i>132</i>
<i>After 50 Hours Or Annually (Whichever Comes First).....</i>	<i>132</i>
<i>Storage And Winterization</i>	<i>137</i>
AXIS WAKE RESEARCH, LLC LIMITED WARRANTY STATEMENT.....	142
TROUBLESHOOTING	152
<i>Troubleshooting The Boat.....</i>	<i>152</i>
<i>Troubleshooting The Trailer.....</i>	<i>154</i>
INDEX.....	157



EMBRACING SAFETY

Signal Words and Symbols Used in this Manual

Throughout this manual specific precautions and symbols identify safety-related information. You will find **DANGER**, **CAUTION**, **WARNING**, and **NOTICE** symbols which require special attention.

Please read them carefully and follow these precautions as indicated! They will explain how to avoid hazards that may endanger you, your passengers, towed participants, and other boaters. **PLEASE REVIEW ALL SAFETY INFORMATION.**



DANGER indicates a hazardous situation which, if not avoided, will result in death or serious injury.



WARNING indicates a hazardous situation which, if not avoided, could result in death or serious injury.



CAUTION indicates a hazardous situation which, if not avoided, could result in minor or moderate injury.

NOTICE

NOTICE is used to address practices not related to physical injury.

Basic Safety Rules

Make sure you understand all of the operating instructions prior to attempting to operate this boat.

Boating-related accidents are generally caused by the operator's failure to follow basic safety rules or written precautions. Most accidents can be avoided if the operator is completely familiar with the boat and its operation, follows recommended practices, and is able to recognize and avoid potentially hazardous situations.

Past accident data shows:

- most **fatalities** involve actions which cause falls or ejections overboard, mishaps with towed persons, propeller strikes, collisions, and carbon monoxide exposure.
- most **injuries** are associated with collisions, mishaps with towed persons, falls or ejections overboard, being struck by the propeller, and fires and explosions.

These incidents are mostly caused by operator inattention, operator inexperience, reckless operation, alcohol/drug use, excessive speed, passenger or towed person behavior, and violation of navigation rules.

Failure to observe the safety recommendations contained in this manual may result in severe personal injury or death to you or to others. Use caution and common sense when operating your boat. Don't take unnecessary chances! Basic safety rules are outlined in this section of the manual.

Pre-operation Check List—Before Leaving the Dock



Failure to follow these precautions may result in severe injury or death to you and/or others.



The operator shall...

- Check that weather conditions are safe for boating. It is the driver's responsibility to determine if weather or other factors have created an unsafe boating environment. Boaters must continuously be aware of weather conditions. Sudden storms, wind, water conditions, lightning, etc., can unexpectedly put boaters in grave danger. Always check the local weather report before going boating.
- Check that drain plugs are securely in place.
- Check bilge pump, horn, lights, blower and other equipment to verify they are operating properly.
- Verify that the emergency cutoff switch lanyard is in proper operating condition and is properly affixed to the driver.
- Check the operation of the steering system. Verify that the steering is operational before launching the boat. If the boat is already in the water, verify proper steering wheel operation at low speed. Turn the steering wheel full stop in both directions and verify proper rudder movement. Ensure that there is no binding or stiffness in the steering wheel rotation. Binding and stiffness are an indication that the steering needs repair. Failure of the steering cable will result in loss of control of the boat.
- Ensure that the load of persons, ballast, and equipment is within the limits stated on the USCG Maximum Capacities Plate and is properly distributed, based on instructions in this manual.
- Check that all safety equipment and life jackets, personal flotation devices (PFDs), and throwable cushions are in good condition and suitable for your boat and passenger load.
- Inform all passengers where safety equipment is located and how to use it.
- Have at least one other passenger who is capable of operating the boat safely in case of an emergency.



GASOLINE VAPORS CAN EXPLODE. BEFORE STARTING ENGINE, OPERATE BLOWER FOR FOUR (4) MINUTES AND CHECK ENGINE COMPARTMENT BILGE FOR GASOLINE VAPORS.

- It is very important to open the engine cover and check the engine compartment and bilge for liquid gasoline and gasoline vapors prior to each use of your boat and after refueling. Failure to do so may result in fire or explosion as well as serious injury or death to you and/or others.
- If you see liquid gasoline in the engine compartment/bilge or smell gasoline vapors, **DO NOT** attempt to start the engine. Liquid gasoline in the bilge is an extreme fire and explosion hazard which may cause injury or death. Find and fix the source of the leakage; remove the liquid gasoline from the bilge. Then ventilate the engine compartment/bilge and run the blower to remove all gasoline vapors before starting the engine.
- If gasoline vapors persist after running the blower, **DO NOT** attempt to start the engine. Likely, there is a gasoline leak that is creating the excessive vapor.
- Always operate blower below cruising speed and after stopping the boat.

Precautions While Underway

The operator shall...

- Check that the area behind the boat is all clear before starting the engine to **AVOID PROPELLER INJURY** to persons in the water behind the boat or on the swim platform.
- Turn off the engine prior to anyone occupying the swim platform or being in the water behind the boat to **AVOID PROPELLER INJURY**. Being in neutral gear is insufficient; the propeller may still be turning, or the engine may be inadvertently shifted into gear.



Failure to follow these precautions will result in serious injury or death.

- Not back the boat toward persons in the water behind the boat to **AVOID PROPELLER INJURY**.
- Not allow people to be on or near the swim platform or in the water near the swim platform while the engine is running because CARBON MONOXIDE will exist around the back of the boat when the engine is running. Engine exhaust contains carbon monoxide, which is a deadly, odorless, colorless gas.
- Not operate the engine in a confined space or while tethered to another vessel as **CARBON MONOXIDE** will be around the boats.
- Not go under the boat cover with the engine running or shortly after the engine has been running because **CARBON MONOXIDE** may remain under the cover. Remove cover to ventilate the area.
- Follow safe operating practices, the "Rules of the Road," and the Watersports Responsibility Code.
- Not operate a boat if under the influence of alcohol or other drugs.



- Attach the emergency cutoff switch lanyard to the boat operator when operating the boat.
- Maintain a proper course and safe speed at all times to avoid collisions.
- Maintain a lookout for other boats, swimmers, and obstructions in the water.
- Operate slowly in congested areas such as marinas and mooring areas.
- Keep a safe distance from other boats, swimmers, personal watercraft, docks, and fixed objects.
- Look before you turn/maneuver the boat so as to avoid potential collisions with oncoming or overtaking vessels.
- Be aware that this boat is a high-performance boat and is capable of quick, tight turns and changes in direction. Familiarize yourself with the handling characteristics of the boat. It is the operator's responsibility to operate the boat in a manner that ensures the safety of all passengers. Abrupt maneuvers may result in the ejection of unsecured, unseated, or improperly positioned passengers. Verbally warn passengers before making quick, tight turns so they may have time to grasp a handrail, handhold, or portion of the boat.
- Be aware that your boat will handle differently, depending on loading and on-board weight distribution.
- Ensure that all passengers are properly and securely seated in appropriate seating locations to avoid falling, or falling overboard.
- Instruct and ensure that passengers remain properly seated at all times while the boat is in motion above idle speed.
- Not allow passengers to sit on the transom, seat backs, engine cover or sides of the boat while the engine is running, and the boat is in motion, to avoid falling overboard.
- Not allow passengers to sit in a position that obstructs the operator's view.
- **NEVER** leave children unattended and in the boat without adult supervision.
- Have children riding in the bow of the boat be accompanied by an adult in the bow and ensure that all remain seated when the boat is in motion.
- Not let passengers occupy seats which may be in the path of the tow line.
- Slow down when crossing waves or wakes in order to minimize the impact on passengers and the boat. Crossing waves or wakes at an angle (such as 45 degrees) rather than perpendicularly will reduce the severity of the impact. Avoid rough water, large waves and large wakes from other boats when at high speed. Jumping waves/wakes or slamming the bow will cause large vertical impacts which may cause injury to occupants or cause ejections.
- For safe towing (water skiing, tubing, wakeboarding, wake surfing, knee boarding, etc.) be experienced and have an observer (an observer or "spotter" is required by law in most states). A rear-view mirror is helpful if you are allowed to tow without an observer in your state.
- Avoid letting tow lines or mooring lines wrap around anyone's body parts/limbs. Doing so could allow body parts/limbs to become entangled in the line and could cause significant injury, such as amputations.
- Keep track of tow lines and dock lines so that they do not become entangled in the propeller. A tow line will wrap quickly around a spinning propeller and is capable of immobilizing the boat and dragging a person entangled in the tow line underwater or causing amputations. Shut off the engine if a tow line has potential for wrapping in the propeller.
- The tower is designed to pull a single individual. Please consult the remainder of this manual and/or warning labels on the tower for details. **DO NOT** climb, sit on, stand on or jump/dive off of the tower. Tow line may loop on inverted tricks. **DO NOT** sit behind the pulling point of the tower.
- **NEVER** allow any type of spark or open flame on board. It may result in fire or explosion.
- Avoid grounding the boat: Be familiar with local conditions and water depth. If you are uncertain, then proceed slowly with caution. Sudden groundings from planing speeds may cause rapid decelerations and cause occupants to impact the boat and/or to be ejected from the boat. Boat damage may also occur.
- Always watch for low obstacles such as tree limbs, bridges or power lines, especially in boats with tow towers.
- Seek shelter from open water if there is threat of lightning or severe weather.
- **NEVER** dive from the boat without being absolutely sure of the depth of the water. Severe injury or death may occur from striking the bottom or submerged objects. Striking the bottom or a submerged object while diving headfirst can cause paralysis, head injury or death.
- Provide assistance to other boaters in distress while ensuring the safety of your own passengers.
- When you leave the boat, take the keys with you. This will keep untrained and unauthorized persons from operating the boat. (This will not be applicable on some keyless ignition systems.)

Safety While Maintaining the Vessel



Failure to follow these precautions may result in severe injury or death to you and/or others.



The operator shall...

- Visually inspect the engine compartment and ventilate after refueling.
- Inspect fuel system regularly. Examine fuel tanks, hoses and fittings for leaks or corrosion at least annually because leaking fuel is a fire and explosion hazard.
- Never remove or modify components of the fuel system in any way except for maintenance by qualified personnel. Tampering with fuel components may cause a hazardous condition which could lead to a fire or explosion.
- Never override or modify the engine neutral starting safety switch in any way. Your boat engine should not start in gear. If it does, do not use the boat until this safety feature is fixed by an authorized dealer.
- Be aware that batteries generate small amounts of dangerous hydrogen gas when charging. This gas is highly explosive. Keep all sparks, flames and smoking well away from the area. Failure to follow instructions when charging a battery may cause an explosion of the battery or the atmosphere near the battery, which could result in death or serious injury.
- Keep the engine off whenever the engine box/cover/hatch is open. The engine box/cover/hatch serves as a machinery guard. Clothing or body parts can get caught in moving parts, causing death or serious injury. Keep away from moving parts.
- Not replace your boat's marine parts with automotive parts or parts that were not designed for your boat.
- Be aware that battery electrolyte fluid is dangerous. It contains sulfuric acid, which is poisonous, corrosive and caustic. If electrolyte fluid is spilled or placed on any part of the human body, immediately flush the area with large amounts of clean water and immediately seek medical attention.
- Check the tightness of the tower bolts **BEFORE** each use. If a tower collapses, it may result in injury to boat occupants or towed persons.
- Not modify the tow bar. The tow pylon/bar is not designed for vertical extensions. Any modifications to the tow pylon/bar or its mountings may result in damage to the boat and injury to the user.
- Only lift the boat from approved lift points, which are identified in later parts of this owner's manual.

OWNER RESPONSIBILITY AND BOATING EDUCATION

Important Safety Information

Your safety, the safety of your passengers, and the safety of other boaters is dependent on how you operate and maintain your boat. As operator or owner of this boat, you are responsible for the safety of those with and around you while boating.

Responsibilities of Boat Owner and Operators

It is the owner's responsibility to ensure that the operator of the boat has been properly instructed in the lawful and safe operation of this vessel. Therefore, before operating the boat, thoroughly read this owner/operator manual. Be sure you understand each item before operating it. Improper operation or trailering of the boat could lead to severe personal injury or death. Improper operation or trailering of the boat may also damage the boat.

The operator and the boat owner assume all risks for themselves, their guests and anyone in proximity to their boat and ensure that all passengers understand the risks and responsibilities associated with boating.

This manual is not intended to provide complete training on all aspects of boat operation. We strongly recommend that all operators of this boat seek additional training on boat handling and safety. Have all operators become familiar with the handling characteristics, and proper steering and control system usage before attempting high-speed operation.

At the time of delivery, the owner/operator is responsible for:

- Understanding the warranty terms and conditions of your boat, your engine, and your trailer.
- Obtaining insurance.
- Examining the boat to ensure the proper operation of all systems.

Before operating the boat, the owner/operator is responsible for:

- Registering the boat as required in the jurisdiction where the boat is being operated.
- Providing the proper (USCG) safety equipment, and checking local, state and federal agencies as to laws and regulations (USCG carriage requirements).
- Carefully reading and understanding safety information and proper operating procedures within this manual.
- Obtaining other boating education if you lack operational experience.
- Familiarizing yourself with the navigable waters where you intend to operate the boat.



- Following the proper break-in procedure for the engine.

Registration

Federal Law requires that all motorboats be registered and that all motorcraft not documented by the U.S. Coast Guard display registration numbers. In nearly all states, this means registration with the designated state agency.

In a few jurisdictions, the Coast Guard retains registration authority. Your dealer will either supply registration forms or tell you where they may be obtained. The agency will supply you with a certificate which must be carried with you when the boat is in operation. International laws may vary as to required registration.

Insurance

The boat owner may be legally responsible for damages or injuries caused by both himself and the operator (if different than the owner). Common sense dictates that you carry adequate personal liability and property damage insurance on your boat, just as you would on your automobile. Many states have laws detailing minimum insurance needs. Your insurance agent or your dealer may be able to supply you with more information. You should also protect your boat from physical damage or theft.

Boating Safety Education Opportunities

It is recommended that the boat owner/operator obtain boater safety education. If you have never owned a boat before, you can get an excellent introduction to boat handling from organizations such as the U.S. Coast Guard, American Red Cross, United States Coast Guard Auxiliary, or your local boating authority. Even if you are a veteran boater, these courses will help sharpen your boating skills as well as bring you up to date on current rules and regulations. See your local boating agency or dealer for information on classes in your area.

Some states require youths, 16 years of age and younger, to complete a boating safety course before operating any watercraft. Many others require operators under the age of 18 to be licensed in small boat operation.

Boat smart from the start: Take a boating safety course and get a free vessel safety check annually for your boat. For more information, contact: United States Coast Guard Auxiliary, www.cgaux.org; United States Power Squadrons, 1-888-FOR-USPS, www.usps.org.

The following is a list of some other agencies and organizations that offer Water Safety, First Aid and CPR courses or information. To find boating safety courses in your area, call your state's local boating agency or the USCG boating safety course line at 1-800-336-2628 (1-800-245-2628 in Virginia).

- USCG Office of Boating (www.uscgboating.org)
- American Red Cross (www.redcross.org)
- U.S. Coast Guard Auxiliary (www.cgaux.org)
- U.S. Power Squadrons (www.usps.org)
- State Boating Offices
- Canadian Power and Sail Squadrons (www.cps-ecp.ca)
- Boat Owners Association of the United States (www.boatus.com)
- National Safe Boating Council (www.safeboatingcouncil.org)
- Water Sports Industry Association (www.wsia.net)
- European or international organizations

Operation by Minors and Licensing

If your boat will be operated by a minor, remember to have an adult present at all times. Many states have laws regarding minimum age and licensing requirements for minors.

Some states require boat training courses, certification, or licensing for minors and/or adults. Contact state and local authorities for requirements that apply in your area.

Your boat and equipment must be in compliance with federal, state and local safety equipment regulations. USCG regulations require certain safety equipment be present on your boat during operation.

For a detailed description, obtain "Federal Requirements for Recreational Boats" published by the U.S. Coast Guard



and available online at:

<http://www.uscgboating.org/images/420.PDF>

In addition to the USCG regulations, other local and/or international law enforcement agencies may have similar requirements. You should check with your local marine law enforcement agency regarding any such requirements before boating.

SAFETY AND REQUIRED EQUIPMENT

Equipment requirements for coastal and inland waters differ. Check with local authorities and/or the USCG for further information about coastal water requirements.

The Federal Boat Safety Act of 1971 (FBSA/71) and the National Recreation Boating Safety Program have established minimum safety standards for boats and associated equipment, specified by the USCG. In addition, the American Boat and Yacht Council (ABYC) and the National Marine Manufacturers Association (NMMA) work with boat builders to develop voluntary standards that exceed the USCG requirements. The included safety equipment on your boat meets or exceeds the standards of the USCG, ABYC and the NMMA.

Some required safety equipment, such as life jackets (PFDs), are not included with your boat. Your dealer can help you choose the appropriate equipment.

NOTICE

Many states' equipment requirements go beyond USCG requirements. Contact your state boating office for further information.

Navigation Lights

Your boat is equipped with navigational lights. Recreational boats are required to display navigational lights between sunset and sunrise and other periods of reduced visibility (fog, rain, haze, etc.). Navigation lights are provided to keep other boats informed of your presence and course. It is up to you to make sure they are operational, displayed correctly, and turned on when required.

Emergency Safety Stop Switch



Your boat is equipped with an Emergency Safety Lanyard (cutoff switch). We recommend that the lanyard be secured to the operator and the lock plate attached to the emergency cutoff switch prior to starting the engine and anytime the engine is operating.

The Emergency Safety Lanyard is designed to turn off the engine whenever the operator moves far enough away from the helm to activate the switch. The purpose is to stop the engine, propeller, and boat in the event the operator leaves the helm location, falls overboard, or is ejected from the boat.

If the engine is stopped it will prevent the boat from becoming a run-away, unmanned boat, which may cause injury or death to boat occupants who have fallen overboard or been ejected, or to other nearby people. If the engine stops it will minimize the subsequent opportunity for propeller contact with the operator or other persons in the water. If the engine and boat stop it will afford opportunity for the operator or other persons who have fallen overboard to safely re-board the boat.

WARNING

It is required by law that you use the Emergency Safety Lanyard system as failure to do so can cause death or serious injury. DO NOT operate the boat if the Emergency Safety Lanyard system does not function properly.

- Attach the Emergency Safety Lanyard to a secure place on your clothing, your arm or your leg while operating.
- **DO NOT** attach the lanyard to clothing that could tear loose.
- **DO NOT** route the lanyard where it could become entangled, preventing it from functioning.



- Avoid accidentally pulling the lanyard during normal operation.
- Loss of engine power means loss of most steering control.
- Without engine power, the boat will decelerate rapidly. This could cause people in the boat to be thrown forward or ejected overboard if they are not properly seated in the boat.

There are practical limitations to what the Emergency Safety Lanyard can do. It can take several seconds for the engine and propeller to stop turning. The boat can continue to coast for several hundred feet depending on the boat speed at the time the switch is activated. While the boat is coasting, it can cause injury to anyone in its path. Accidental loss of power can be hazardous particularly when docking or in heavy seas, strong current, or high winds.

While at the dock or when the boat is not moving, periodically disconnect/pull the Emergency Safety Lanyard out of the switch while the engine is running to test for proper operation. The engine should shut off when the lanyard is disconnected/pulled from the switch. You should not be able to restart the engine until the lanyard is back in place.

Personal Flotation Devices

Federal law requires that you have at least one wearable Personal Flotation Device (PFD) of the proper size (Type I, II, III or V), for each person on board or being towed, and at least one throwable PFD (Type IV) in the boat.

PFDs must be Coast Guard-approved, in good and serviceable condition and the appropriate size for the user. To meet requirements, each lifesaving device must have a current, legible USCG approval stamp permanently affixed. At the beginning of each season, inspect life jackets (PFDs) for damage and test for proper flotation. Refer to the life jacket (PFD) manufacturer’s information.

REMEMBER—The best PFD is the one that is worn—that is, the one that can save your life.

PFDs are intended to save lives; it is highly recommended that you and your passengers wear them while in the boat. Learn how to use them and adjust as necessary for comfort. It is especially important that children and non-swimmers wear a life jacket (PFD) at all times.

Make certain all passengers know where life jackets are located, how to put on and properly adjust their life jackets (PFDs), and that life jackets are readily accessible at all times. Your dealer can help you select appropriate life jackets (PFDs) and throwable lifesaving devices for your area. Some PFDs are specially made for use while water skiing or wakeboarding and are not USCG-approved.

Please check local law with respect to their use. Some states require children to wear a PFD at all times.

There are four types of wearable PFDs (Type I, II, III or V) and one throwable type of PFD (Type IV) used for throwing in emergency situations. Examples of these USCG-approved PFDs are shown:



Type I PFD —Offshore Life Jacket: This PFD is designed for extended survival in rough, open water. It usually will turn an unconscious person face up and has over 22 pounds of buoyancy. This is the best PFD to keep you afloat in remote regions where rescue may be slow in coming.



Type II PFD—Near Shore Buoyant Vest: This “classic” PFD comes in several sizes for adults and children and is for calm inland water where there is chance of fast rescue. It is less bulky and less expensive than a Type I, and many will turn an unconscious person face up in the water.



Type III PFD—Flotation Aid: These life jackets are generally considered the most comfortable, with styles for different boating activities and sports. They are for use in calm water where there is good chance of fast rescue since they will generally not turn an unconscious person face up. Flotation aids come in many sizes and styles.



Type IV—Throwable Device: These are designed to be thrown to a person in the water. Throwable devices include boat cushions, ring buoys, and horseshoe buoys. They are not designed to be worn and must be supplemented by wearable PFD. It is important to keep these devices immediately available for emergencies.



Type V PFD—Special Use Device: Special use PFDs include work vests, deck suits, and hybrids for restricted use. Hybrid vests contain some internal buoyancy and are inflatable to provide additional flotation. These PFDs may be used instead of a Type I, II, or III PFD with non-towed participants if used in



accordance with the approval conditions on the label and if worn when the boat is underway. Some Type V PFDs provide increased protection against hypothermia.

NOTICE

A Type V PFD must be worn to be counted toward the minimum carriage requirements.

NOTICE

Special life jackets are available for skiing and other watersports. These non-Coast Guard-approved life jackets do not count as PFDs.

Fire Extinguisher

A portable fire extinguisher is required if your boat has an inboard engine, or when fuel is stored in closed stowage compartments.

Approved fire extinguishers are classified by a letter symbol, either B-I or B-II with the B designating that the material will extinguish flammable liquids such as gasoline, oil, etc. B-I extinguishers are required for boats less than 26 feet in length, unless there is an automatic fire extinguishing system installed.



For boats over 26 feet in length, two (2) B-I extinguishers or one (1) B-II extinguisher is required. If an automatic fire extinguishing system is installed in a boat over 26 feet in length, one (1) B-I hand-held extinguisher is still required. An automatic system is available as an option on Axis boats. Hand-held units are not included in standard equipment so that the consumer can choose from a wide range of fire extinguishers, many of which exceed the minimum requirements. If the boat does not have an automatic fire extinguishing system installed, the boat owner **MUST** purchase and install at least one B-I-rated fire extinguisher (two [2] B-I extinguishers or one [1] B-II extinguisher for boats over 26 feet in length).

Fire Extinguisher Requirements				
Fire Extinguisher Type & Quantity	Vessel Length			
	< 16'	16'–26'	26'–40'	40–65'
One B-I <i>(when enclosed compartment)</i>	✓	✓		
One B-II or two B-I. <i>Note: fixed system equals one B-I.</i>			✓	
One B-II and one B-I, or three B-I. <i>Note: fixed system equals one B-I.</i>				✓

Check periodically to ensure that the extinguisher is in working condition and fully charged. Check local, state and federal agencies as to laws and regulations.

Horn or Whistle

All boats over 16 feet (4.8 meters) in length must be equipped with an operable horn or whistle. Test the operation of the horn periodically, so as to make sure it will sound when you actually need to alert someone or another boat.

The following are standard signals when using a whistle or a horn:

- **One prolonged blast:** Warning.
- **One short blast:** Pass on my port (left) side.
- **Two short blasts:** Pass on my starboard (right) side.
- **Three short blasts:** My engines are in reverse.
- **Five or more blasts:** Danger!

Bilge Pump(s)

Bilge pump(s) are installed in your boat to remove water that may accumulate in the bilge. Know the location of the pump(s), where they discharge, and where switches are located. Typically, there are manual switch and/or an automatic switch position(s). On boats equipped with the Viper II system, the bilge pumps are controlled via the touch screen for manual operation.

Periodically test the operation of bilge pumps by activating the manual switch and observing the water discharge. It is best to leave the bilge pump switches in automatic mode, so as to not allow excess water to unknowingly accumulate in the bilge of your boat. If your bilge pump comes on too frequently or continuously, investigate the source of leaking water (check for hull damage, hose or piping leaks, missing drain plug, exhaust system or ballast system failures, etc.), and/or return to shore. Excess water in the bilge of your boat can cause loss of engine power, sinking, and/or capsizing.

Visual Distress Signals

All vessels used on coastal waters, the Great Lakes, territorial seas, and those waters connected directly to them up to a point where a body of water is greater than two miles wide, must be equipped with USCG-approved visual distress signals. Your dealer or local authorities can help you select appropriate visual distress signals for your area.

If you are required to carry distress signals, you must have three USCG-approved pyrotechnic devices. Be sure they are in serviceable condition, not exceeding the expiration date and stored in a cool, dry location in a red or orange waterproof container.



Pyrotechnic signaling devices can cause fire and/or explosion, death, serious injury, and property damage if improperly handled. Follow the pyrotechnic manufacturer's directions.

Recommended Safety Equipment

As a precaution, a prudent boater will avoid potential problems on an outing by having additional equipment on board. Normally, this equipment is dependent on the size and type of the body of water and the length of the trip. Your dealer can assist you in acquiring this additional equipment.

We recommend the following equipment:

- First aid kit and manual
- Anchor with at least 75 feet (23 meters) of line
- Mooring lines and fenders
- Bailing device (bucket, hand pump)
- Combination paddle/boat hook
- Local charts and compass
- Day/night distress signals
- Waterproof flashlight and spare batteries
- Cellular phone
- Waterproof container for cell phone
- GPS Global Positioning System
- Binoculars
- Portable AM/FM radio with weather band
- A non-electric horn or whistle
- Extra engine oil
- Tool kit
- Spare propeller and mounting hardware
- Spare fuses
- Spare keys
- Sunglasses and sun block lotion



GENERAL BOATING SAFETY TOPICS

Safe Speed

Navigation rules state that a boat be operated at a safe speed at all times. Determination of a safe speed involves consideration of many factors, such as, but not limited to:

- Boating activity (tubing, water skiing, wakeboarding, wake surfing, etc.)
- Boat traffic congestion
- Water conditions
- Environmental conditions (shoreline, docks, and depth of water)
- Weather
- Visibility

The boat should not be driven at a rate of speed faster than will allow it to be brought to a full stop within the operator's field of view given the environmental conditions at the time. Safe speed for the conditions and driver attention (lookout) are important factors in avoiding collisions which may cause injury or death. When in doubt it is prudent to slow down within adequate time and distance so as to be able to assess the conditions and paths of other boats.

It is important to know the Rules of the Road, although do not assume that all boaters also know the rules or that they will abide by them. Avoid collisions by constantly assessing the ever-changing situation and be sure to make appropriate speed and course changes early.

Passenger Safety

The operator of the boat is responsible for the safety of the passengers, all skiers/riders, as well as his/her own safety. Ensure that you and your passengers adhere to these safety recommendations:

- Any time you take your boat out, make sure that there is at least one other passenger aboard who is familiar with the operation of your boat.
- Ensure that all passengers are properly and securely seated in appropriate seating locations to avoid falling or falling overboard.
- While the engine is running, and while the boat is maneuvering, all occupants should be properly seated. **DO NOT** stand while the boat is moving.
- **DO NOT** sit on the engine box, seat backs, transom seating, sun pad, boarding platform or gunwales while the boat is underway. You could fall overboard and be hit by the propeller, or another boat.
- **DO NOT** allow objects, arms or legs, or any other body parts to hang over the bow or gunwales. Stay within the boat.
- Passengers should not sit in locations that obstruct the operator's visibility.
- Persons and gear should be stowed in a way that distributes weight appropriately and in a manner that trims the boat properly (pitch angle). Excessive weight at either the bow or the stern relative to one another can cause trim problems leading to reduced driver visibility, erratic steering, loss of control, or bow submergence and flooding/swamping.
- Passengers should be well aware of emergency equipment and instructed in its use.
- Passengers should assist with lookout duties and notify the operator of any approaching watercraft or potentially unsafe conditions to provide assistance with collision avoidance.

Carbon Monoxide Safety

Carbon Monoxide (CO) is a deadly, colorless and odorless gas produced by all engines and fuel-burning appliances. Even with the best boat design and construction, plus the utmost care in inspection, operation and maintenance, hazardous levels of carbon monoxide may be present in or near the boat under certain conditions. The boat owner, operator, as well as all boat occupants, must understand the dangers of carbon monoxide and must comply with all safety recommendations/requirements. For boats with cabins, always ventilate the boat interior and avoid boating situations which cause increased exposure.



Carbon monoxide (CO) can cause brain damage or death. Engine and generator exhaust contains odorless and colorless carbon monoxide gas. Carbon monoxide will be around the back of the boat when engines or generators are running. Move to fresh air, if you feel nausea, headache, dizziness, or drowsiness.



- **DO NOT** allow people to be on or near the swim platform or in the water near the swim platform while the engine is running. Carbon monoxide will exist around the back of the boat when engines are running.
- **DO NOT** operate the engine in a confined space or while the boat is tethered to another vessel.
- **DO NOT** go under the boat cover while the engine is running or shortly after the engine has been running. Carbon monoxide may be trapped under the cover. It is important to remove the cover and/or ventilate the area before going under the boat cover.
- **DO NOT** “platform/teak” surf or platform drag. Carbon monoxide will exist in high concentrations in the vicinity of the swim platform near the water while the engine is running. The USCG has deemed platform dragging as a dangerous and hazardous activity which should be prohibited, as it can result in injury or death.
- In the event that someone exhibits the symptoms of carbon monoxide exposure (nausea, headache, dizziness, or drowsiness), have them breathe fresh air and, if necessary, immediately seek medical attention.

Hazardous boating situations involving carbon monoxide include:

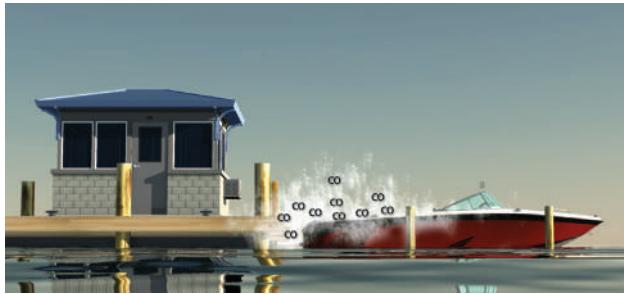

Blockage of boat exhaust by obstruction.

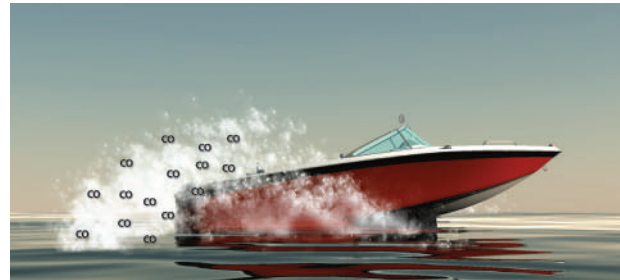

Operating with high bow angle.

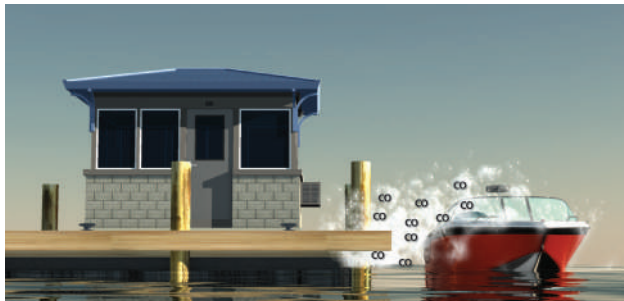

Exhaust traveling along obstruction.



Exhausts from other vessels in confined areas.

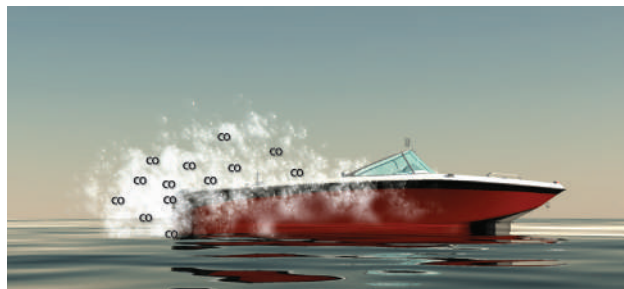

Operating at slow speed or while dead in the water.

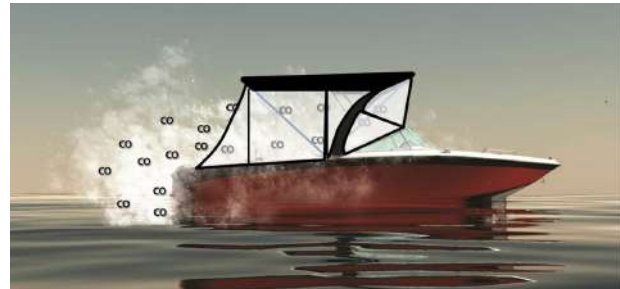

Operating with canvas tops and side curtains in place without ventilation.

For the most current information on carbon monoxide, you may call, write, or visit online any of the following:

<p>United States Coast Guard Office of Boating Safety (CG-5422) 2100 Second Street SW STOP 7581 Washington, DC 20593-7581 www.uscgboating.org/safety/carbon_monoxide.aspx</p>	<p>NMMA 231 S. LaSalle St., Suite 2050 Chicago, IL 60604 312-946-6200 www.nmma.org</p>	<p>American Boat & Yacht Council, Inc. 613 Third Street, Suite 10 Annapolis, MD 21403 410-956-4460 www.abycinc.org</p>
---	---	--



Proper Loading



DO NOT overload your boat. Overloading or uneven loading can cause loss of control, capsizing, or swamping, which may lead to death or serious injury. Adhere to the load capacity plate restrictions, and always account for persons, gear, and all non-factory-installed ballast or other equipment.

Your boat is equipped with a maximum load capacity plate indicating the maximum acceptable load as determined by the manufacturer following certain Federal guidelines. In addition to following these weight guidelines, it is critical that you properly distribute this weight throughout the boat. If too much weight is placed in one area it can have serious impact on the boat's handling and control, which has the potential to lead to injury or death.

The load capacity plate is used by boat manufacturers participating in the National Marine Manufacturers Association certification program. Your manufacturer has submitted your model for inspection and compliance with their guidelines.

The maximum number of persons allowed on the boat has been determined by the manufacturer and displayed on the capacity plate. (Additional information regarding weight distribution appears in the *Get Ready* section of this owner's manual.) This information on the capacity plate applies under normal conditions and special care must be used in any abnormal conditions. Check the capacity plate on your boat and abide by these limits.

The capacity plate has the following information permanently printed on it:

- ***The total weight of persons, gear and other items which the boat is capable of carrying under normal conditions. This weight must include any added ballast above and beyond boat manufacturer's factory-installed ballast system(s), such as the manufacturer's-approved, optional Plug 'n Play (which has been factored into the maximum capacity) or any other added, but unapproved ballast.***



Any non-factory-installed ballast must be properly secured to prevent injury.



DO NOT fill the bilge area with water. Excessive water in the bilge can cause changes in boat trim and reduce boat stability which may lead to submergence or capsizing.

Weighting Your Boat During Watersport Activities

Although water intrusion and waves spilling inside a boat is an obvious boating hazard, this hazard can be increased when weighting your boat for water sports such as wakeboarding or wake surfing. As wakeboarding has evolved, ballast systems have been developed to add weight and increase the size of the wake. The simplest ballast system on the market is the water ballast type, such as the "FAT SAC."

The quest for the largest wake has caused some boat operators to excessively overload their boats. It is not uncommon to see operators use aftermarket ballast systems and then put additional people and gear in their boat.

Be advised that this practice can lead to overloading your boat which may lead to any of the following: changes in handling and performance; capsizing, flooding, and sinking; boat occupants going overboard. **DO NOT** overload your boat.

Always be aware of the load in your boat and do not load the boat in excess of the listed capacity. Each boat has a maximum capacity label displaying the maximum weight of people, gear and ballast that can be placed in the boat.

When loading your boat, give attention to the effect that the load distribution has on the boat's trim angle. Trim angle is the technical term for the up or down pitch angle of your boat (also known as the "bow up" or "bow down" angle). The fore and aft load distribution of weight, passenger, and gear can affect the running trim angle of the boat.

- Excessive weight placed in the stern of the boat can cause the inability to get on plane, high bow-up angles, and can lead to steering difficulties. High bow-up angles can be dangerous due to the reduction in the operator's forward visibility which can lead to collisions and groundings. High bow-up angles cause longer transition times from displacement mode (slow velocity,



0 to 5 mph) to planing speeds (18 to 20 mph and above). During transition, it is important that the boat operator pays attention so that they are able to see forward and that the time in transition (or in the “hump” speed region) is minimized.

- Excessive weight placed in the bow of the boat can lead to very flat planing trim angles which may lead the boat to turn aggressively, unpredictably, and without steer input. The phenomenon of yaw instability is caused by heavy bow weights and running very flat (bow down or flat trim angles). This can occur with excessive weight in the bow compared to weight in the stern of the boat. Another ill effect of too much bow weight in comparison to stern weight is that with extremely heavy bow loads, the boat’s bow may dive or submerge when coming off plane (decelerating rapidly or encountering waves/wakes at slow speed). If the bow submerges, then water will enter and flood your boat.
- When encountering conditions which may lead to bow diving or bow submergence, it is recommended to accelerate the boat before the wave/wake in order to help raise the bow and get over the wave/wake.
- If the bow submerges, the recommended action is to reduce throttle to stop forward speed, get passengers to move aft, and turn on the bilge pump.

It is the boat operator’s responsibility to tell passengers to move to other seats on the boat, so as to not overload the stern or bow of the boat, nor restrict the boat operator’s forward visibility. (See *Get Ready* section of this owner’s manual for additional information.) There is no single recommended seating or load distribution for all conditions. Experience with your boat will allow you to determine where to properly allow passengers and gear to be placed.



Excess and improper loading of bow area forward of windshield may cause water influx, operating instability, and loss of control resulting in injury or death. Bow Capacity Limit - X persons or XXX lbs. person, gear and ballast. This is posted separately on your boat but still included in overall capacity. Use good judgment when weighting your boat for any towed water sports.

Visibility of the Operator

The operator of the boat is responsible, by law, to “maintain a proper lookout by sight and hearing.” The operator must ensure that he/she has appropriate visibility for safe operation. No passengers or equipment should block the operator’s view, including the view of other boats, skier(s), rider(s), swimmer(s), or anyone or anything else in the water. Even momentary interference can result in the driver’s inability to respond to a situation that requires avoidance of another vessel or submerged or partially submerged object(s).

Look carefully before turning, especially when you are turning around to pick up a fallen skier/rider. Other boats in your vicinity may not necessarily be following the Rules of the Road. Be alert and keep a visual check for other boats in and around your intended path. Do not turn or maneuver your boat without first checking that it is clear to do so. Failure to look before turning can result in an encounter with another boat where neither boat has enough time to avoid a collision. This situation can develop very quickly if you fail to look first and turn in front of another oncoming boat.



Obstructed visibility can cause death or serious injury. The operator must maintain clear visibility at all times while operating the boat. Arrange passengers and equipment appropriately or designate a passenger to assist when visibility is limited.

Boating Under the Influence



Operating the boat or boating under the influence of alcohol and/or drugs can cause serious injury or death. Alcohol and drugs slow your reaction time and impair your judgment. Do not operate a boat or allow passengers to boat while under the influence of alcohol and/or drugs.

Boating under the influence of alcohol or drugs can be deadly. Alcohol and/or drug use is the leading contributing factor to all recreational boating fatalities. Alcohol and drugs can increase your reaction time and impair your judgment. Combined with the sun, wind, waves, and noise of other watercraft, the effects of drugs and alcohol can be increased and can significantly increase your reaction time. As the owner/operator, you are responsible for the alcohol/drug use and onboard behavior of your passengers. Additionally, civil lawsuits in cases of property damage or injury/death to others can result in significantly higher verdicts when alcohol or drugs are allowed.





Impaired operation may result in severe personal injury or death. Federal and state laws prohibit operating a boat under the influence of alcohol and other drugs. If the operator's blood alcohol content is above the legal limit, violators are subject to fines and may go to jail. Violators may also lose automobile driving privileges.

Product Misuse

Misuse of the product or use of it in a manner for which it was never intended can create dangerous situations. The boat operator and passengers are responsible for using the product safely and as intended. The driver must operate the boat in a manner that ensures the safety of all passengers. If you or your passengers are unsure about the proper use of the product, unsure about performing certain boating maneuvers or are unsure about a particular water activity, refer to this owner's manual or contact a knowledgeable source, such as your local dealer, the US Coast Guard, or your local boating authority.

Reporting Accidents

Boat operators may be required by law to file a Boating Accident report with their state boating law enforcement agency or local authority, the USCG, or their country's boating law enforcement agency when their boat is involved in certain boating accidents. A boating accident must be reported if there is a loss or probable loss of life or a personal injury requiring medical attention beyond first aid. In these situations, a formal report must generally be filed within 48 hours of the accident.

Also, a boating accident must be reported for accidents when damage exceeding \$500 is incurred or there is a complete loss of the boat. In these situations, a formal report must generally be filed within 10 days. If any of these events occur, seek further assistance from local law enforcement personnel. Please note that the submittal of a report is the responsibility of the boat owner. This requirement is different than laws associated with the reporting of automobile accidents.

Rendering Assistance

If you see a distress signal or suspect a boat is in trouble, you must assume it is a real emergency and render assistance immediately. By law, the operator in charge of the craft is obligated to provide assistance to any individual in danger, presuming assistance can be safely provided. Failure to render assistance can result in a fine and/or imprisonment.

The 1971 Boating Safety Act grants protection to a "Good Samaritan" boater providing good faith assistance and absolves a boater from any civil liability arising from such assistance.

Hazardous Conditions

Every waterway poses hazards that should be avoided. You will be best prepared to avoid these hazards if you are familiar with the waterway where you are boating. Whenever possible familiarize yourself with navigation charts, depth charts, and waterway maps before you go boating. The following information outlines some of the most common hazards which may be encountered:

Shallow Water Operation

Shallow water brings on obvious hazards such as sand bars, stumps, rocks, etc. Know the area in which you will be operating the boat. Grounding the vessel or striking submerged objects can result in serious injury or death and can cause severe damage to your watercraft. At high speed, this can cause rapid deceleration or stop your boat abruptly, which may cause occupants to impact the interior of the boat or be ejected. Stick to deeper water whenever possible, and if you must travel in shallow water, proceed at low speed and post a lookout. Know the minimal depth your boat can safely travel.

Warning Markers

Learn to recognize the different buoys and day markers; they are used as the signposts of the waterways identifying navigable routes and water hazards. It is a good idea to ask local authorities about hazard areas and if they are marked. Stay within boundaries and clear of hazards.



Weeds

Weeds can generally be a threat to a boat's engine and other components on the boat. If weeds wrap around the propeller, they can create vibration in the engine. They also can restrict water intakes or clog the water filter, causing the engine to overheat.

Learn to recognize the typical normal operating temperature range for your engine. If temperature rises high above normal, then check for blockage of the engine cooling water system.

NOTICE

Weeds can sometimes be removed by shifting to NEUTRAL, pausing for a moment, then shifting to REVERSE to unwind the weeds from the propeller.

Dam Spillways

The area around dam spillways is very hazardous and conditions can change rapidly. Keep clear of the spillways and areas below dams. Currents created by spillways can draw in objects, including your boat.

Restricted Areas

Before boating, check with Local, State, and Federal authorities to identify restricted areas. Because of the threat of terrorism, the U.S. Coast Guard has and will continue to implement strict limits on watercraft near U.S. Navy and Coast Guard ships and other potential targets.

Weather/Seas

Learn and understand weather patterns and signs of change. Bad weather can cause an uncomfortable and unsafe situation. If a storm approaches, seek a safe harbor. Check forecasts before getting underway and continue to monitor conditions while on the water.

Environmental Concerns

As a boater, you already appreciate nature's beauty and the peace of the great outdoors. It is a boater's responsibility to protect the natural environment by keeping waterways clean.

Foreign Species

If you trailer your boat from lake to lake, you have the potential of unknowingly introducing a foreign aquatic species from one lake to the next. It is important to thoroughly clean the bottom of the boat below the water line, remove all weeds and algae, and drain the bilge, ballast, and livewells before launching the boat in a new body of water. Check local, state, country agencies as to laws and regulations.

Fuel/Oil Spillage

The spilling of fuel or oil into our waterways contaminates the environment and is dangerous to wildlife.

DO NOT EVER discharge or dispose of fuel, oil or other chemicals into the water; it is prohibited and can result in fines. These are three common, accidental types of discharge:

- During initial fueling of a nearly empty tank
- Overfilling the fuel tanks
- Pumping contaminated bilge water

WARNING

Fumes from rags can collect in the bilge and pose an extremely hazardous fire and explosion risk, which can result in injury or death. Never store rags used to wipe up fuel or solvent spills in the boat. Dispose of rags properly ashore.

Discharge/Disposal of Waste

Waste means all forms of garbage, plastics, recyclables, food, wood, detergents, sewage and even fish parts in certain waters—in short, nearly everything. We recommend you bring back everything you take out with you for proper disposal ashore.

Excessive Noise

Noise means engine noise, radio noise, loud conversation, or even yelling. Many bodies of water have adopted noise



limits. Noise can carry a considerable distance on water, especially at night. Be sure to follow regulations and be courteous.

Speed/Wake/Wash

Be alert for **NO WAKE** zones. You are responsible for any damage or injury caused by your wake/wash. Prior to entering a **NO WAKE** zone, reduce throttle, come off plane to the slowest steerable speed. Use caution when operating around smaller crafts, in channels and marinas, and in congested areas.

Some states and boating areas have imposed speed limits for the operation of boats, including, but not limited to, no-wake zones. Check local, state, and federal agencies as to laws and regulations. The U.S. Coast Guard and local boating authorities are excellent sources for this information, which can include penalties for failure to observe the requirements.

Exhaust Emissions

Increased exhaust (hydrocarbon) emissions pollute our water and air. Keep your engine tuned and boat hull clean for peak performance. Consult your Axis dealer for information.

Paints

If your boat is kept in water where marine growth is a problem, the use of anti-fouling paint may reduce the growth rate. Be aware of environmental regulations that may govern your paint choice. Contact your local boating authorities for information.

Cleaning Agents

Household cleaners should be used sparingly and not discharged into waterways. Never mix cleaners and be sure to use plenty of ventilation in enclosed areas while cleaning your boat.

DO NOT use products which contain phosphates, chlorine, solvents, non-biodegradable or petroleum-based products. Refer to the *Care and Maintenance* section in this manual for more information.

MARPOL Treaty

The USCG enforces the International Convention for the Prevention of Pollution from ships, commonly referred to as the MARPOL Treaty (Marine Pollution). This treaty prohibits the overboard dumping of all ship-generated plastics, chemicals, garbage and oil.

ON-PRODUCT WARNING LABELS

Warning Labels & Locations

Warning labels are placed at specific locations on your Axis boat at the time of manufacture to alert you to potential hazards that may not be obvious. These labels also indicate how to avoid these hazards. Warning labels should never be removed and must remain legible. If you suspect a label is missing, or if a label becomes damaged or becomes unreadable (damaged, faded, or sun bleached), contact your dealer for replacement.

It is the responsibility of the boat owner and occupants of the boat to understand and comply with all warning labels and safety recommendations/requirements. The driver of the boat and the boat owner are responsible for the proper operation of the boat and the safety of the occupants of the boat.

Failure to adhere to and comply with the on-product warning labels and safety statements labeled as dangers, warnings, and cautions that appear in this manual can lead to serious injury, or death, as well as property damage.

READ AND ADHERE TO ALL WARNING PLATES AND LABELS from bow to stern, including those that are installed inside the engine compartment, lockers, and underneath seating.



axis warning labels

Windshield Decal (Model-Specific)

WARNING
Failure to follow these warnings could cause serious injury or death.

REMAIN PROPERLY SEATED AND HOLD ON TO AVAILABLE HANDRAILS while boat is moving to avoid falling overboard or being ejected from the boat. Do not sit on gunwales or deck edges. **USCG APPROVED LIFE JACKETS** should be on board for all passengers and on all towed participants.

DO NOT EXCEED THE BOW CAPACITY of 4 persons or 600 pounds. Overloading the bow of the boat can cause loss of control, swamping and/or capsizing.

DO NOT OBSTRUCT OPERATOR VISIBILITY. Operators must have a clear view in front of them to avoid collisions.

Walk-Thru Decals

WARNING
Failure to follow these warnings could cause severe injury or death.

- GASOLINE VAPORS CAN EXPLODE - BEFORE STARTING ENGINE:**
 - OPERATE BLOWER (if available).
 - CHECK THE ENGINE COMPARTMENT for gasoline vapors by sight and smell.
- OPERATE BLOWER to clear gasoline vapors from engine compartment when engine is at idle, while before starting engine and after stopping engine.
- CARBON MONOXIDE (CO) CAN CAUSE BRAIN DAMAGE OR DEATH.** Engine exhaust contains carbon monoxide gas. Signs of carbon monoxide poisoning include nausea, headache, dizziness, and confusion. **MOVE TO FRESH AIR** if anyone shows signs of carbon monoxide poisoning. **SEE OWNER'S MANUAL** for additional information regarding carbon monoxide poisoning.
- CHECK WEATHER FORECAST BEFORE DEPARTING DOCK and heed all weather advisories.
- WEAR SAFETY LANYARD at all times while operating boat to prevent unintended boat operation.
- NEVER OPERATE WHILE UNDER THE INFLUENCE of drugs or alcohol.
- DO NOT OVERLOAD THE BOAT. ENSURE THAT WEIGHT IS PROPERLY AND EVENLY DISTRIBUTED fore and aft and on both sides of the boat to avoid poor handling, sudden loss of control, swamping and/or capsizing.
- USCG APPROVED LIFE JACKETS SHALL BE ON BOARD FOR ALL PASSENGERS AND TOWED PARTICIPANTS.
- MAKE SURE THAT ALL PASSENGERS ARE PROPERLY SEATED WHILE UNDERWAY. To avoid passengers falling overboard or being ejected from the boat, do not allow passengers to sit on seat back, gunwale or outboard deck edges while boat is moving.
- REDUCE SPEED BEFORE ATTEMPTING SUDDEN OR SHARP TURNING AND MAINTAIN SAFE SPEEDS for water conditions and environment at all times. Maneuverability at high speeds is limited, and sudden turns may cause loss of boat control.
- KEEP PROPER LOOKOUT AND SAFE DISTANCE for the conditions at all times to avoid collisions.
- BEYOND APPLICABLE NAVIGATION RULES AND BOATING LAWS.
- USE CAUTION AND PROPER LIGHTING during nighttime boating and boating in adverse weather.
- READ THE OWNER'S MANUAL AND COMPLETE THE BOATER'S PRE-OPERATION CHECKLIST prior to boat operation.

DANGER
Rotating propeller may cause serious injury or death. Do not approach or use ladder while engine is running.

WARNING
Failure to follow these warnings could cause serious injury or death.

Only use this tow pylon for waterskiing, boarding, or recreational towables. Do not use this tow pylon for parasailing, kite flying, pyramids, group pulls, barefoot/leaching booms, pylon extensions or towing other boats. Do not sit in the path of the tow line when it is in use.

WARNING
Failure to follow these warnings while using the tow tower could cause serious injury or death.

Lock the tower in place and secure all hardware before and during use. Do not tow more than 1 persons or 500 pounds at one time from this tow tower. Only use this tow tower for waterskiing, boarding, or recreational towables. Do not use this tow tower for parasailing, kite flying, pyramids, group pulls, towing other boats, or tubes. Do not climb on, sit on, stand on, jump off of or dive off of the tow tower.

Walk-Thru Decals (Model-Specific)

WARNING
Failure to follow these warnings could cause serious injury or death.

Remain properly seated and hold on to available handrails while boat is moving to avoid falling overboard or being ejected from the boat. Do not sit on gunwales or deck edges.

Do not overload the boat. Occupants and gear must be evenly distributed on both sides of the boat to avoid poor handling, sudden loss of control, swamping and/or capsizing.

Refer to your specific model's Designated Occupant Positions depicted in the Owner's Manual.

Keep limbs and body clear of all tow lines at all times to avoid entanglement and other types of injuries.

USCG approved life jackets should be on board for all passengers and all towed participants.

MAXIMUM CAPACITIES
16 PERSONS OR 2256 LBS.
2256 POUNDS, PERSON, GEAR

THIS BOAT COMPLIES WITH U.S. COAST GUARD SAFETY STANDARDS IN EFFECT ON THE DATE OF CERTIFICATION WITH THE EXCEPTION OF CERTAIN FUEL SYSTEM REQUIREMENTS ASSOCIATED WITH ITS FUEL INJECTED ENGINE AS AUTHORIZED BY U.S. COAST GUARD GRANT OF EXEMPTION (CGR 06-08). MAINTENANCE OF THE FUEL SYSTEM IN THIS BOAT SHOULD BE PERFORMED ONLY BY EXPERIENCED MALIBU TRAINED TECHNICIANS USING IDENTICAL FUEL SYSTEM COMPONENTS.

MANUFACTURER: MALIBU BOATS, LLC
MODEL: Axis T235 LOUDON, TN

DESIGN COMPLIANCE WITH NMMA REQUIREMENTS BELOW IS VERIFIED. MFGOR, RESPONSIBLE FOR PRODUCTION CONTROL.

NMMA CERTIFIED NATIONAL MARINE MANUFACTURERS ASSOCIATION

Engine Compartment Decals

WARNING
LEAKING FUEL IS A FIRE AND EXPLOSION HAZARD, INSPECT SYSTEM REGULARLY. EXAMINE FUEL TANKS FOR LEAKS OR CORROSION AT LEAST ANNUALLY.

WARNING!
SERVICE OF THE ENGINE ON THIS BOAT REQUIRES SPECIAL TOOLS, TRAINING AND GENUINE REPLACEMENT PARTS WHICH ARE ONLY AVAILABLE FROM MALIBU BOATS COMPANY. THE FUEL SYSTEM SHOULD BE SERVICED ONLY BY A MALIBU TRAINED CERTIFIED TECHNICIAN. DO NOT ATTEMPT TO SERVICE THE SYSTEM YOURSELF.

Transom Decals

NOTICE
ENSURE CAP IS TIGHT FOR PROPER COOLING SYSTEM PERFORMANCE

Fuel Cap Decals

WARNING
Contents can be under pressure. Avoid serious injury or death from fire or explosion. Open slowly in well-ventilated area, no smoking or open flames.

WARNING
The use of E-15 fuel in this vessel is prohibited by law. See Owners Manual for complete explanation.

DANGER

CONTACT WITH A SPINNING PROPELLER WILL CAUSE SERIOUS INJURY OR DEATH. STAY CLEAR OF BOAT AND STAY OFF SWIM PLATFORM WHILE ENGINE IS RUNNING.

CARBON MONOXIDE (CO) CAN CAUSE BRAIN DAMAGE OR DEATH. Engine exhaust contains odorless and colorless carbon monoxide gas.

Carbon monoxide will be around the back of the boat while engines or generators are running. **MOVE TO FRESH AIR**, if you feel nausea, headache, dizziness, or drowsiness.

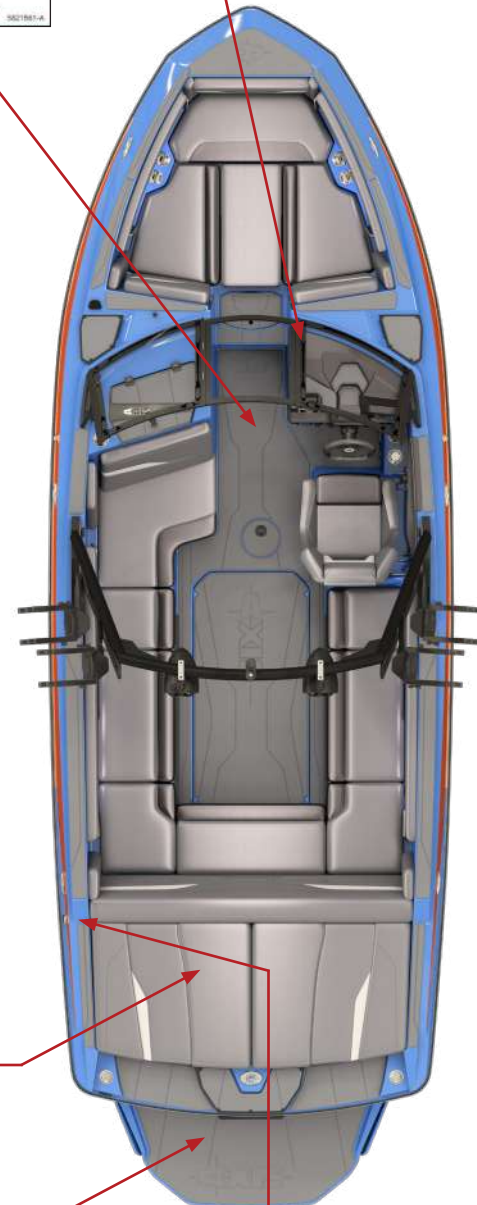

BASIC RULES OF THE ROAD

Boating Regulations

The U.S. Coast Guard (USCG) is the governing authority of the United States waterways and serves to help the boating public. State boating regulations are enforced by local authorities. Owners and users outside of the United States must be cognizant of that country's laws and regulations.

You are subject to marine traffic laws and Rules of the Road for both federal and state waterways; you must stop if signaled to do so by enforcement officers and permit them to board if asked.

Review and understand all local, state, federal, and country boating laws.

Increasingly, governmental bodies are establishing new laws, rules and regulations regarding specific water activities. Because of the widespread interest in wakeboarding and wake surfing, the state in which you are wakeboarding/wake surfing may:

- Require operators to stay a specific distance from all shorelines, docks, piers or other structures. That means the channel or body of water will need to be of a defined width to be considered acceptable.
- Require riders engaging in towed watersports to wear a U.S. Coast Guard-approved life jacket.
- Prohibit wakeboarding/wake surfing during the hours between sunset and sunrise.
- Prohibit wake surfing behind a boat with an exposed propeller that extends beyond the boarding platform.
- Prohibit wakeboarding/wake surfing on small bodies of water, i.e., less than fifty (50) acres.

Even in areas not governed by similar laws, these kinds of requirements and limitations represent a common-sense approach to recreation.

There are many USCG pamphlets available to you. These pamphlets go beyond the contents of this manual and explain Rules of the Road, signal lights, buoys, safety, international and inland regulations. An example is the *Ultimate Watersports Handbook* you should have received with your new boat, or which can be ordered by contacting WSIA; go to: www.WSIA.net. For more information, contact your local USCG Unit or visit <http://www.uscgboating.org>.

You should be aware of these rules and follow them whenever you encounter another vessel on the water.

The rules presented in this manual outline only the most basic of the nautical Rules of the Road and have been provided as a convenience only. Consult your local U.S. Coast Guard Auxiliary (USCGA), Department of Motor Vehicles (DMV) or local maritime authority for a complete set of rules governing the waters in which you will be using your boat. If you plan to travel—even for a short trip—you would be well-served to contact the regional USCGA or DMV in the area where you will be boating.

The nautical Rules of the Road must be followed to prevent collisions between vessels. Like traffic laws for automobiles, the operator is legally required to follow the rules.



Collisions between boats can cause death or serious injury. Keep a proper lookout, safe speed, and follow the nautical Rules of the Road.

Encountering Another Vessel

Any time two vessels on the water meet one another, one vessel has the right-of-way. It is called the “stand-on” or “privileged vessel.” The vessel which does **NOT** have the right-of-way is called the “give-way” or “burdened vessel.” These rules determine which vessel has the right-of-way, and accordingly, what each vessel should do.

Privileged Vessel

The privileged vessel has the right-of-way and has the duty to continue its course and speed, except to avoid an immediate collision. When you maintain your direction and speed, the other vessel will be able to determine how best to avoid you.



NOTICE

In general, boats with less maneuverability have right-of-way over more-agile crafts. You must stay clear of the vessel with right-of-way and pass to his stern.

Sailboats and boats paddled or rowed have the right-of-way over motorboats. Sailboats under power are considered motorboats. Small pleasure craft must yield to large commercial boats in narrow channels.

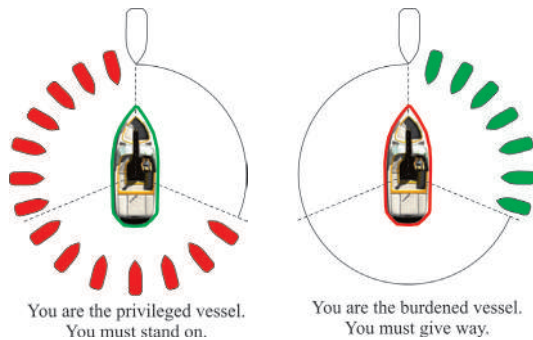

Burdened Vessel

The burdened vessel does not have the right-of-way and has the duty to take positive and timely action to stay out of the way of the privileged vessel. Normally, the burdened vessel should not cross in front of the privileged vessel. The burdened vessel should slow down or change directions and pass behind the other vessel. The burdened vessel operator should always move in such a way that the privileged vessel operator can see what you are doing in ample time to avoid a collision.

Crossing

In crossing situations, the boat to the right from the 12 o'clock to the 4 o'clock position has the right-of-way, and it must hold course and speed. The burdened boat passes behind the privileged boat. Boats going up and down a river have the privilege over boats crossing the river. The illustration depicts a situation in which you are the boat in the center, and you are the privileged vessel. You must hold course and speed. All vessels approaching your vessel from the directions depicted by the red vessels must yield to your boat.

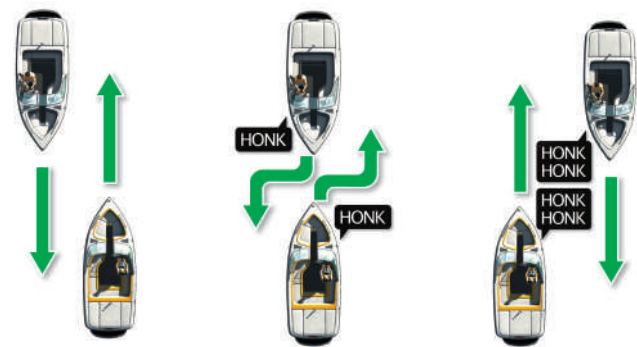

Conversely, the illustration depicts a situation in which you are the boat in the center, and you are the burdened vessel. You must give right-of-way to all vessels coming towards you from the directions shown in green.

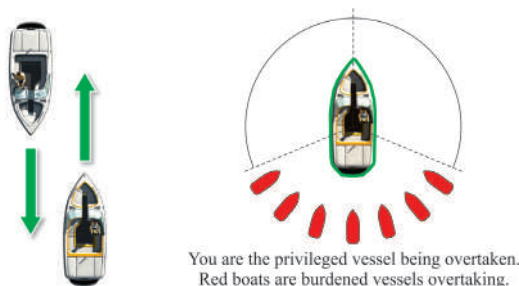

Meeting Head-On

When meeting head-on, neither vessel has the right-of-way. Both boats should decrease speed, turn towards their right (starboard side) and pass on their left sides (port-to-port). However, if both boats are clearly on each other's right (starboard) side then, each vessel should sound two short blasts and pass on their right sides (starboard-to-starboard).

Overtaking

The boat that is overtaking one ahead of it is the burdened boat and must make any adjustments necessary to keep out of the way of the privileged boat, until the burdened boat is well ahead and clear of the vessel being overtaken.

The General Prudential Rule

The General Prudential Rule regarding right-of-way, is that if a collision appears unavoidable, neither boat has right-of-way. As prescribed in the Rules of the Road, both boats must act to avoid collision.

Rule 2 in the International Rules says, "In construing and complying with these Rules due regard shall be had to all dangers of navigation and collision and to any special circumstances, including the limitations of



the vessels involved, which may make a departure from these Rules necessary to avoid immediate danger.”

Other Rules of the Road

When navigating in narrow channels, you should keep to the right when it is safe and practical to do so. If the operator of a power-driven vessel is preparing to go around a bend that may obstruct the view of other water vessels, the operator should sound a prolonged blast on the whistle or horn—four to six seconds.

If another vessel is around the bend, it too should sound the whistle or horn. Even if no reply is heard, however, the vessel should still proceed around the bend with caution.

If you navigate this types of waters, you should carry a portable air horn, which is available from local marine supply stores.

Aids to Navigation

Learn to recognize the different buoys and day markers; they are the signposts of the waterways. The United States Aids to Navigation System (USATONS) is the primary marking system used on inland waters, coastal waters and rivers in the United States. This system is maintained by the U.S. Coast Guard (USCG).

There are two primary marking systems in use in the U.S.: the Uniform State Waterway Marking System (USWMS), used on inland waters and maintained by each state, and the Federal Waterway Marking System (FWMS), used on coastal waters and rivers and maintained by the USCG. In addition, the FWMS has two modified systems: the Western River Buoyage, and the Intracoastal Waterway Buoyage. Be sure to check with local authorities on the buoyage system in use in your boating region.

The type of hazard/warning buoys and markers depends on the area of jurisdiction. Check with local boating authorities.

USWMS System

In the USWMS Lateral System, well-defined channels are marked with red and black buoys, and the boat should pass between them.

The USWMS Cardinal System is used when there is no well-defined channel or where an obstruction may be approached from more than one direction. With the cardinal system:

- Pass north or east of **BLACK-TOPPED WHITE** buoy.
- Pass south or west of **RED-TOPPED WHITE** buoy.
- **RED** and **WHITE VERTICALLY STRIPED** buoy indicates boat should pass outside of the buoy (away from shore).

FWMS System

The FWMS Lateral System is for use on navigable waters except Western Rivers and Intracoastal Waterways. The markings on these buoys are oriented from the perspective of being entered from seaward (the boater is going toward the port). This means that red buoys are passed on the starboard (right) side of the vessel when proceeding from open water into port, and green buoys to the port (left) side.

- The right side (starboard) of the channel is marked with **RED**, even numbered buoys.
- The left (port) side of the channel is marked with **GREEN**, odd numbered buoys.
- The middle of the channel is marked with **RED** and **WHITE** vertically striped buoys; pass close to these buoys.
- Obstructions, channel junctions, etc. are marked with **RED** and **GREEN** horizontally striped buoys.
- A **RED** band at the top means the preferred channel is to the left of the buoy; a **GREEN** top band means the preferred channel is to the right of the buoy.
- Day markers are colored and numbered the same as buoys. **RED**, triangular day markers with even numbers mark the starboard side of the channel. **GREEN**, square day markers with odd numbers mark the port side of the channel.

Lights, bells and horns are used on buoys for night or poor visibility conditions. Buoys with unique light flashing characteristics are identified on nautical charts with the specific flashing pattern.



Spherical Safe Marker Buoy



Types of Buoys

There are several types and shapes of buoys. Buoys may be unlighted, lighted, with sound or may have both an audible and a visual signal. Lights, bells and horns are used on buoys for night or poor visibility conditions. Different shapes of buoys are shown following.

Buoys with unique light flashing characteristics are identified on nautical charts with the specific flashing pattern.

Mooring Buoys

The only buoys from which you are permitted to moor are mooring buoys. Mooring buoys are white with a blue horizontal stripe. Mooring to a navigation buoy, regulatory markers or lateral markers is illegal.



Unlighted Bell Buoy



Spar Buoy

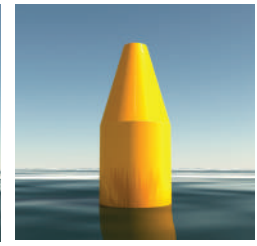

Nun Buoy

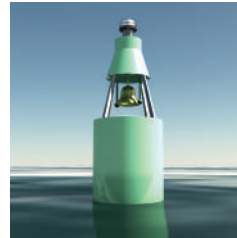

Lighted Buoy

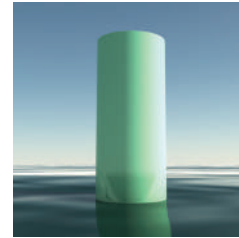

Can Buoy



Mooring Buoy

Uniform State Regulatory Markers

Regulatory markers indicate dangerous or restricted controlled areas. These markers are used to indicate speed zones, areas set aside for particular use, general information and directions.

Regulatory markers are white with orange geometric shapes and also have orange bands near the top and at the water line of the buoy. You must obey regulatory markers.



Controlled Area



Danger



Boats Keep Out



Information

Uniform State Waterway Marking System (USWMS)



Diver's Flag

Used by recreational divers—indicates position. Stay far away from diver flags—someone is underwater in the vicinity.



Alpha Flag

Worldwide vessels engaged in diving operations—does not indicate diver's position.



Distress Flag

Indicates fellow boater is in need of assistance.

Warning Markers

It is a good idea to ask local authorities if there are hazardous areas and how they are marked. Boaters must also recognize the flag designs, which indicate that skin divers are present and keep well clear of the area. Divers underwater cannot be seen. Stay well away from boats or floats displaying Diver Flags.

Watch for swimmers. Swimming areas may not be marked. Steer clear from the area and remain alert.

Navigation markers serve as a means of identifying navigable

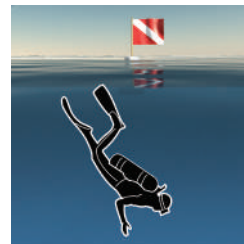

Skin Diver Warning Flag



Swim Area Warning Buoy



routes and indicate water hazards. Boaters should become familiar with navigation markers and stay within marked boundaries and clear of hazards.

Night Running

Operation of your Axis boat between sunset and sunrise in some locations may be restricted or not allowed at all. It is the responsibility of boat owners and boat operators to verify the laws, rules and regulations regarding nighttime operation for the body of water upon which you are running.

Boats operating between sunset and sunrise (hours vary by state) must use navigational lights. Nighttime operation, especially during bad weather or fog can be dangerous. All Rules of the Road apply at night, but it is best to slow down and stay clear of all boats, regardless of who has right-of-way.

Protect your night vision by avoiding bright lights and have a passenger, if possible, help keep watch for other boats, water hazards and aids to navigation. It is best to proceed slowly at night, as there is always the possibility of unlit boats, floating objects, and fixed objects which will be very difficult to see in time to avoid if you are at planing speeds or above.

There are many light patterns on different types of boats performing various functions while underway or at anchor. For most applications on recreational boats the following navigation light patterns are applicable.

(NOTE: Information is included here that does not apply to Axis boats. However, the information is included here to assist Axis operators in being aware of the navigational lights that may appear on other vessels you may encounter.)

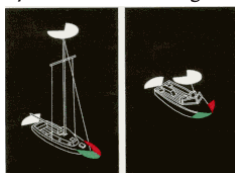

Figure 1—

Motorboats less than 20 meters (65.62 feet) shall exhibit navigation lights as shown in Figure 1. (Note: Two masthead lights are optional for boats under 50 meters. Boats over 50 meters [164 feet] will display two masthead lights.)

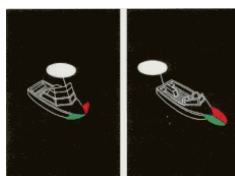
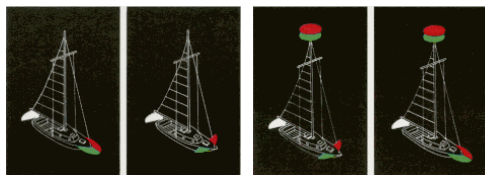

Figure 2—

Motorboats of less than 12 meters (39 feet, 4 inches) in length, may show the lights in either Figure 1 or Figure 2. Boats of less than 7 meters (23 feet) whose maximum speed cannot exceed seven (7) knots may exhibit an all-around white light, and, if practicable, sidelights instead of the lights prescribed above, in international waters only.



Figures 3 & 4—

Sailboats and watercraft under oars: Sailboats less than 20 meters (65.62 feet) may exhibit the navigation lights shown in Figures 3 or 4.



Figure 5—

Another option for sailboats is to use a single combination lantern at the top of the mast as shown in Figure 5.

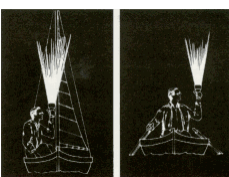

Figure 6—

Sailboats less than 7 meters (22.96 feet) may carry an electric torch or lighted lantern showing a white light to be displayed in sufficient time to prevent collision (see Figure 6). If practicable the lights prescribed for sailboats less than 20 meters should be displayed.

Watercraft under oars (such as a canoe) may display the lights prescribed for sailboats, but if not, must have ready at hand an electric torch or lighted lantern (flashlight) showing a white light to be displayed in sufficient time to prevent collision (see Figure 6).

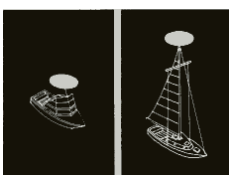

Figure 7—

Anchored boats: Motorboats and sailboats at anchor must display anchor lights. An anchor light for a watercraft less than 50 meters (164 feet) in length is an all-around white light, visible for two (2) miles exhibited where it can best be seen (see Figure 7).

Sailboats operating under machinery, or under sail and machinery, are considered power-driven and must display the lights prescribed for a power-driven boat.

WATERSPORTS SAFETY

Skiers or riders are obligated to be aware of the same fundamental safety rules as boat operators. If you are new to water skiing, wakeboarding, wake surfing, and other towed watersports, seek certified training before starting. You will find it especially helpful to join a local ski club, World Wakeboard Association, and/or USA Water Ski, when possible.

Always remember that the majority of injuries occurring while water skiing/wakeboarding and other towed watersports are the result of impacts with other objects. Always look where you are going and be aware of what is going on around you.

When participating in towing watersports, be safe and courteous and follow these guidelines:

- Be considerate to fishermen and others who are sharing the same body of water.
- **DO NOT** perform watersports in congested areas.
- Stay away from navigation markers.
- Stay away from other boats and watersports participants.



Contact with a spinning propeller can cause injury and death. Do not enter or exit the water when the engine is running (ON) and the propeller is spinning. Do not get on the swim platform when the engine is running. Do not swim toward the back of the boat if the engine is on.



Failure to adhere to these warnings may result in severe injury or death to you and/or others.

- Every towed person must always wear a USCG-approved personal flotation device.
- Always have an experienced driver and a designated observer in the boat while being towed.
- Maintain a distance of at least 100 feet from all other objects, including other boats, piers, rafts, mooring and navigational buoys, pilings, abutments, or any other items.
- Never water ski, wakeboard or participate in other towed watersports in shallow water, close to shore, or in water where you do not know the depth or what is beneath the surface.
- Never put your arm, head, or any other part of your body through the handle-bridle of the tow line nor wrap the line around any part of the body at any time.
- **DO NOT** participate in watersports while under the influence of alcohol and/or drugs.
- **DO NOT** participate in watersports during inclement weather or on rough water.
- Never water ski, wakeboard or participate in other towed watersports directly in front of other boats who may run over you if you fall.
- Never water ski, wakeboard or participate in other towed watersports at night.
- Never jump from a boat that is moving at any speed.
- Make sure that everyone knows and uses approved towed watersports hand signals.

Hand Signals

Make sure that everyone knows and uses approved towed watersports hand signals, as shown.

Towed Person Safety Responsibilities

Most injuries and fatalities that occur on high-performance recreational tow boats occur to the persons being towed (water skiing, kneeboarding, wakeboarding, wake surfing, tubing, etc.).

It is the responsibility of the boat operator to pay attention to a multitude of things while utilizing the boat for water tow sports. The towed person has little or no control over their path nor do they have much in the way of protection from impact with obstacles or other boats. Therefore, it is recommended that boat operators, observers, and towed persons communicate effectively and clearly as to their intentions and their surroundings. The main responsibilities for each participant are as follow:



Operators should...

- Assign a passenger to be a designated observer.
- Turn the engine off whenever a person is on the swim platform or in the water near the boat. This is especially important for the area near the back of the boat to avoid propeller injuries.
- Ensure that it is “all clear” behind the boat when starting the engine. Ask for verbal confirmation or hand signals that it is “all clear” behind the boat. Then, and only then, start the engine.
- Keep their main focus on maneuvering the boat safely while avoiding other boats, fixed objects, the shore, and shallow water.
- Use rear view mirrors to allow the driver to glance at the towed person, while still keeping their main attention on the path of the boat and the surroundings.
- Return safely to pick up towed persons or persons in the water. Keep the individual in view, approach slowly (preferably on the driver’s side), and shut off the engine when close to an individual in the water. **DO NOT** back up or operate the boat in reverse to a person in the water.

Observers should...

- Confirm for the boat operator that it is “all clear” behind the boat prior to starting the engine.
- Watch the towed person.
- Be responsible for communication of the signals and status of the towed person to the boat driver.
- Notify the boat operator of status and changing conditions with the towed person and inform the boat driver of the towed person’s readiness to start, their desire to go faster or slower, or that they have fallen and are in need of retrieval.
- Deploy the fallen skier flag when the towed person falls, if needed. In some states, it is required to raise the “fallen skier” flag when the skier has fallen.
- Monitor the tow line to ensure that it does not become tangled, it does not become wrapped around anyone in the boat, and it does not become wrapped around the towed person. Also monitor the tow line so that it does not become tangled in the propeller. Notify the boat operator if any of these conditions are observed to avoid potential injury.
- Remind the boat operator to shut off the engine when persons are on the swim platform or in the water near the back of the boat.

Towed persons should...

- Wear a PFD.
- Not approach the back of the boat if the engine is running.
- Not become entangled in a tow line or wrap a tow line around any body part.
- Know signals to communicate with the observer and boat operator.

Additional Precautions for Towed Skier/Rider

- Wear wet suits or protective shorts when engaging in high energy skiing/riding to prevent abrasions, hypothermia, and injuries to orifices (rectal and vaginal) from impact with the water surface.
- Inspect watersports equipment for wear, fraying, etc., before use. **DO NOT** use if they show signs of wear or fraying. Ropes or watersport equipment tow points may break during use, causing you to coast into obstacles or fall with the risk of being struck by another vessel.
- Inspect the boat tow points before use. If there is any evidence of corrosion or other damage, do not use until it has been inspected by your authorized Axis dealer.
- **NEVER** attach ski/wakeboard rope to anything but approved pylons and wakeboard towers. Make sure tow ropes are properly attached to the boat tow points.
- The skier/rider should verbally indicate that (s)he is safely clear of the boat prior to operator starting the boat engine or putting the boat into gear.
- Slowly take up slack in tow lines before accelerating to watersports speeds. Jerking the slack out of a tow line can cause high forces on the rope and towing equipment. This may cause the rope or equipment to break and the rope to snap back at occupants of your boat and at the towed person.
- Never put your arm, head or any other part of your body through the handle/bridle of the ski or wakeboarding line, nor wrap the line around any part of the body at any time. If you fall, the line will tighten and forcefully constrict around your body part and may result in amputation.
- **DO NOT** ski near swimming areas, beaches, personal watercraft, or other vessels/boats.
- Never attempt land or dock starts. These activities will increase your risk of injury or death.
- **DO NOT** jump from a boat that is moving at any speed, nor enter or exit the water when the engine is running.
- **DO NOT** “back up” to anyone in the water; they will be in danger of hitting the spinning propeller which can cause severe injury or death.
- **DO NOT** follow directly behind another boat or skier/rider without leaving an adequate safe distance in case that towed person falls into the water. You will need ample time and distance to maneuver your boat away from that person in the water.



and to avoid their tow boat which will be circling back to retrieve their downed person.

- **DO NOT** participate in towed watersports at night. It is illegal and other boats will not be able to see you, nor will they anticipate or expect your presence behind the towing boat. Furthermore, once you fall, they will not see you swimming.
- **DO NOT** tow with multiple skier/riders with different length ropes.
- **DO NOT** ski in limited visibility conditions.
- Never climb, sit or stand on a wakeboard tower. The wakeboard tower is intended for towing only as noted. It is designed to pull a limited number of individual(s), and in some cases only one (1) individual. Please consult the remainder of this Owner's Manual and warning labels on the tower for details. The wakeboard tower approved for use on your boat should be used only for water skis, wakeboards or recreational towables, and not for parasailing, kite flying or towing other boats.
- Many states require the use of "skier down" flags. Check your local lake and state requirements. Having the observer raise a skier down flag when your towed watersport participant falls down or off the towed device will alert boats around you to the fact that someone is in the water nearby and that they should avoid the area.
- Many lakes have recommended tow patterns. Other boats may expect that you know the local customs and practices. It is common that the tow pattern is counterclockwise around the lake, but there are exceptions. Check for local recommendations or requirements.
- **NEVER** lift or trailer the boat with water in the bilge or in ballast tanks. Lift or trailer per manufacturer's instructions.
- Around marina docks where electrical current is present (such as shore power connections) it is unsafe to swim as stray electrical currents may exist, which can cause you to drown.

Tow Line Guidelines

Tow lines come in different lengths and strengths for different activities. Make sure any line you are using is suited for skiing or riding and that it is in good condition.

- Never use a tow line that is frayed, knotted, unraveling or discolored from use or being left in the sun. If a line breaks while in use it can recoil at the skier/rider being towed or into the watercraft where it might strike passengers. Replace tow lines with any sign of damage.
- Never use a tow line with elastic or bungee material to pull skiers or riders.
- Tow line should be attached to the watercraft in an approved fashion with hardware designed for towing. Refer to your watercraft manual for instructions on proper tow line attachment.
- Always route tow lines away from the propeller, even when idling. Shut off the engine if your boat starts to cross a floating tow line.
- If a tow line should become entangled in a propeller, shut off engine, remove the key and put it in your pocket before retrieving the line.
- Tow lines should be neatly coiled and stowed in the boat when not in use.

Fallen Skier or Rider

Falling and injuries are common in water skiing and other towed watersports. Keep tow speeds in a comfortable range given the rules of the activity and the skill level of participants.

- Display a red or orange skier/rider down flag to alert other vessels that a skier/rider is down. In some states, it is required to raise the "fallen skier" flag when the skier has fallen.
- Turn the boat and slowly circle toward the person in the water to return the tow line handle or towed device to that person.
- Always keep the fallen skier/rider in view and preferably on the operator's side of the watercraft.
- Put the watercraft in neutral whenever you are near a fallen skier/rider.
- Shut off the engine when retrieving someone from the water or if the person in the water gets too close to the boat. **Do not trust neutral gear with an idling engine.** Someone may accidentally or prematurely shift the gear, or the linkages may be out of adjustment and the propeller may still be slowly spinning.

Develop WATER SENSE

The Watersports Responsibility Code and the Watersports Safety Code have been developed by WSIA and industry equipment manufacturers. These Codes are reproduced here for your reference.

Watersports Responsibility Code

Familiarize yourself with and follow The Watersports Responsibility Code.

WATERSPORTS SAFETY CODE

Before you get in the water: Skiing or riding instruction is recommended before use. Instruction will teach general



safety guidelines and proper skiing or riding techniques, which may reduce your risk of injury. For more information on skiing or riding schools, contact your dealer, association, or local ski club.

WATER SPORTS RESPONSIBILITY CODE

Be aware that good judgment and personal awareness can help reduce the risks in boating and water sports. To increase your enjoyment of water sports, follow the elements of the responsibility code.

In water sports it is your responsibility to:

- ALWAYS familiarize yourself with applicable laws, waterways and inherent risks
- ALWAYS have a capable observer in addition to driver and agree on hand signals
- ALWAYS wear a USCG type III, ISO or other agency approved (PFD) Life Jacket
- ALWAYS read user's manual and inspect equipment before use
- ALWAYS ski or ride under control, at proper speeds and within your limits
- ALWAYS turn ignition off when anyone is near watercraft power drive unit
- ALWAYS stay clear of engine exhaust to avoid Carbon Monoxide poisoning
- ALWAYS make sure the engine cutoff lanyard is connected to the driver
- NEVER "platform drag" or touch swim platform while the engine is running
- NEVER ski or ride near swimmers, shallow water, other boats, or obstacles
- NEVER operate watercraft, ski or ride under the influence of alcohol or drugs
- NEVER accelerate until rope is clear of body parts

wsia
WATER SPORTS INDUSTRY ASSOCIATION

BOAT
Responsibly

- Know the federal, state and local laws that apply to your area.
- If you are not familiar with a waterway, ask someone who is knowledgeable to tell you about any hidden dangers or things to avoid.
- Whether you plan to be in a watercraft, or skiing/riding behind one it is important you are wearing a properly fitted life jacket (PFD) approved by your country's agency, USCG Type III, ISO, etc.
- Inspect all equipment prior to each use, check bindings, fins, tube, attachment, tow rope and flotation device. **DO NOT** use if damaged.

Watercraft Safety: A knowledgeable and responsible driver is the most important safety device on any watercraft.

- Never operate a watercraft, ski or ride under the influence of alcohol or drugs.
- Only use water ballast and people for additional weight.
- Never exceed the passenger or weight limitations of the watercraft.
- Never allow passengers to hang outside the watercraft or towed device or sit on the gunwales or anywhere outside of the normal seating area.
- Never allow water to overflow the bow or gunwales of the watercraft.
- Uneven weight distribution or additional weight may affect the handling of the watercraft.

Carbon Monoxide: The exhaust from the engine on a watercraft contains Carbon Monoxide (CO) which is a colorless, odorless and poisonous gas. Excessive exposure to CO can cause severe injury or death. Follow this advice to avoid injury.

- Never "Platform Drag" by holding onto the boarding platform or being dragged directly behind the watercraft. This is where CO will be.
- Do not sit on the watercraft transom or the boarding platform while the engine is running.



- Make sure the engine is properly tuned and running well. An improperly tuned engine produces excessive exhaust and CO.
- If you smell engine exhaust do not stay in that position.
- Go to the United States Coast Guard's website: (www.uscgboating.org) for more information on how to help protect yourself and others from the dangers of CO.

Tow Ropes: Tow ropes come in different lengths and strengths for different activities. Make sure any rope you are using is suited for that activity and that it is in good condition.

- Never use a rope that is frayed, knotted, unraveling or discolored from use or being left in the sun. If a rope breaks while in use it can recoil at the skier/rider being towed or into the watercraft where it might strike passengers. Replace tow ropes with any sign of damage.
- Never use a tow rope with elastic or bungee material to pull skiers or riders.
- Rope should be attached to the watercraft in an approved fashion with hardware designed for towing. Refer to your watercraft manual for instructions on proper tow rope attachment.
- Always keep people and tow ropes away from the propeller, even when idling.
- If a tow rope should become entangled in a propeller, shut off the engine, remove the key and secure it in a safe location before retrieving the rope.
- Tow ropes should be neatly stowed in the boat when not in use.

Preparing to ski or ride: Always have a person other than the driver act as an observer to look out for the skier/rider.

- Be sure the driver is aware of the experience and ability of the skier/rider.
- The driver, observer and skier/rider need to agree on hand signals before skiing or riding. Signals should include **READY**, **STOP**, **SPEED UP** and **SLOW DOWN**.
- Start the engine only after making sure that no one in the water is near the propeller.
- Turn the engine off when people are getting into or out of the watercraft, or in the water near the watercraft.
- Always make sure the tow rope is not wrapped around anyone's hands, arms, legs or other parts of the body.
- Start the watercraft and move slowly to remove slack until the tow rope is tight.
- When the skier/rider signals **READY** and there is no traffic ahead, take off in a straight line. Adjust the speed according to the signals given by the skier/rider.

Skiing or riding: The watercraft and skier/rider should always maintain a sufficient distance from obstacles so a skier/rider falling or coasting and/or watercraft will not encounter any obstacle.

- Do not use in shallow water or near shore, docks, pilings, swimmers, other watercraft, or any other obstacles.
- Use only on water.
- Never attempt land or dock starts. This will increase your risk of injury or death.
- Always wear a properly fitted life jacket (PFD) approved by your country's agency, USCG Type III, ISO, etc.
- The faster you ski or ride, the greater your risk of injury.
- Never make sharp turns that may cause a slingshot effect on the skier/rider's speed.
- The skier/rider should be towed at an appropriate speed for his or her ability level.

Fallen skier or rider: Falling and injuries are common in skiing or riding.

- Circle a fallen skier/rider slowly to return the tow rope handle or pick up the fallen skier/rider.
- Turn off the engine when near a fallen skier/rider.
- Always keep the fallen skier/rider in view and on the driver's side of the watercraft.
- Display a red or orange skier-down flag to alert other vessels that a skier/rider is down if required by the state in which you are operating.

The Warnings and practices in the Watersports Safety Code represent common risks encountered by users. The code does not cover all instances of risk or danger. Please use common sense and good judgment.

EMERGENCY PROCEDURES

In an emergency situation, you may have to resort to measures which are not commonly practiced. Always assess the dangers of being in harm's way versus the protection of equipment. Keep a sound mind during an emergency and always use common sense.



Explosion and Fire

Many boat fires and explosions involve flammable liquids such as gas or oil, which are used in your boat's propulsion engine(s) and generator. Carefully follow all warning labels and safety precautions while handling flammable substances. Many fires in inboard boats start in the bilge area due to gasoline vapors. Gasoline vapors are heavier than air and collect in the bilge of boats.

Explosion

- If explosion is imminent, put on PFDs, grab distress signals and survival gear, and immediately abandon ship.

Fire

- Immediately turn off engines, generators, stoves and blowers.
- Extinguish smoking materials.
- A fixed fire suppression system, if equipped, has heat sensors that automatically flood the machinery space with a fire extinguishant. Allow extinguishant to "soak" the compartment for at least 15 minutes to cool the hot metals or fuel before cautiously inspecting the fire area. Have portable fire extinguishers ready. Do not breathe fumes or vapors caused by the fire or extinguishant.
- If no fixed fire suppression system is installed and a fire is in the engine compartment, discharge portable fire extinguishers through the engine compartment access plate, if equipped. **DO NOT** open the engine hatch as this feeds oxygen to the fire.
- If you have access to the fire, direct the contents of the fire extinguishers at the base of flames, not at the top.
- Throw burning materials overboard if possible.
- Move anyone not needed for firefighting operations away from the flames.
- Signal for help.
- Put on PFDs (Personal Flotation Devices), grab distress signals and survival gear, and prepare to abandon ship.



Burn hazard from gasoline floating on water which is ignited can cause death or serious injury. Gasoline will float on top of water and can burn. If the boat is abandoned, swim upwind, far enough to avoid fuel that can spread over the surface of the water.

Swamping and Flooding

In the event that the vessel begins to take on water, turn on the bilge pump to evacuate water and slow its accumulation, and try to determine the source of the water. A collision with an underwater object can cause the hull to develop a leak. A loose-fitting hose clamp on a piece of equipment can cause a leak. Try to repair the leak if possible. If a leak is threatening the safety of you and your passengers, call or signal for assistance.

- Turn on bilge pump(s).
- Access PFDs, pass them out to everyone, and put them on.
- Identify source of leak and try to stop the leak and flooding.
- **STAY WITH THE BOAT!** A boat will usually float even if there is major hull damage. Rescuers can spot a boat much easier than a head bobbing in the water.
- Signal or call for help.
- If others were on board, try to locate them, make sure that they are conscious and that they can swim.
- Immersion in water speeds the loss of body heat and can lead to hypothermia (the abnormal lowering of internal body temperature).

Capsizing

- If others were on board, try to locate them, make sure that they are conscious and they can swim.
- If possible, access life jackets (PFDs), pass them out to everyone, and put them on.
- **STAY WITH THE BOAT!** A boat will usually float even if there is major hull damage. Rescuers can spot a boat much easier than a head bobbing in the water.
- Signal or call for help.
- Immersion in water speeds the loss of body heat and can lead to hypothermia (the abnormal lowering of internal body temperature).



Staying Afloat

- Remain calm. Do not thrash about or try to remove clothing or footwear. This leads to exhaustion and increases the loss of air that may keep you afloat.
- Keep your life jacket (PFD) on.
- Keep your knees bent.
- Float on your back and paddle slowly to safety.

Collisions

- Immediately account for all passengers.
- Check for injuries.
- If any person is in the water, make sure they have proper flotation devices.
- Assess the hull for damage.
- Activate the bilge pump(s) to reduce any flooding.
- Try to operate the boat to keep the damaged area above water.
- If necessary, call or signal for assistance.
- **STAY WITH THE BOAT!**

Grounding

In the event you run aground, assess the situation before proceeding. Your response to grounding will depend on how hard the boat hits bottom and whether the boat remains stranded, the extent of damage, and proximity to shore and help.

- If it is a simple touch, you may need only to inspect the hull.
- If you are aground, assess the situation before reacting. In some cases, throwing the boat into reverse can cause more damage.
- Check for leaks and immediately stop any water from entering the boat.
- Inspect the hull, steering system and propulsion system for damage.
- Maneuver the boat to safe water only if the hull and all operating systems are in satisfactory operating condition. Otherwise, call or signal for assistance.

Person Overboard

- Immediately react to a person who has fallen overboard by sounding an alarm.
- Keep the victim constantly in your sight.
- If another passenger is on board, assign them to look at and keep pointing at the person in the water. They are to do nothing else but stay focused on the person in the water and to point at them.
- Throw the person a life preserver even if they are wearing a PFD. It will serve as a marker in the water and will provide additional flotation.
- Immediately slow or stop the boat and safely circle toward the victim as soon as possible.
- Keep the victim on the helm side of the vessel so as to keep the victim constantly in your sight.
- When almost alongside, shut off the engine.
- Assist the person into the boat.

Unassisted Means of Reboarding

There is only one way to reboard, unassisted, onto an Axis boat. To reboard, use the following procedure:

- Move to the swim platform on the transom of the boat.
- Place both hands, palms down, onto the top of the platform.
- Using your legs to kick upward, pull your body and legs up over the edge of the swim platform.
- Use the grab handles that are mounted to the transom of the boat to gain additional leverage.
- Lean into the swim platform and swing one leg up onto the swim platform. Then use the grab handle to provide support while pulling the rest of your body onto the swim platform.
- Stand up and maintain three points of contact with the boat. Use the transom step to climb back into the boat.



Be aware that there are metal surfaces mounted on the hull beneath the swim platform. Do not allow arms, legs, or body parts to extend below the swim platform as these surfaces may cause minor-to-moderate injuries.



Drowning

- Swim to rescue a drowning victim only as a last resort.
- **Immediate resuscitation is critical!** It may be possible to revive a drowning victim who has been under water for some time and shows no sign of life. Start CPR immediately and get the victim to a hospital as quickly as possible.
- Keep the victim warm.
- Use care in handling. Spinal injury may exist if the victim fell overboard.
- Call and signal for help.

Medical Emergency

In an emergency, you may be far from professional medical assistance. Be prepared and know how to use your first aid kit. Be aware of any special medical conditions of your passengers.

Operation Failure

If you experience a propulsion, electrical, steering or control failure, immediately shut off the engine. If it is safe to do so and you are qualified, then try to determine the cause of the failure and repair. Otherwise, call or signal for assistance. Anchor the boat if drifting will put you and others in danger.



WARNING

Towing or being towed stresses the boats, hardware and lines. Failure of any part can seriously injure people or damage the boat.

Towing

A recreational boat towing another should be a last resort due to the potential for damaging one or both boats. The Coast Guard or a private salvage company is better equipped for this activity. A recreational boat may assist by standing by, and possibly by keeping the disabled boat's bow at a proper angle until help arrives. Only when conditions are ideal—that is, waters are calm, disabled boat is small, appropriate hardware is available, and one or both skippers know the correct technique—should a recreational boat tow another.

Towing Vessel

- Be sure your boat will not run aground too.
- Because you are maneuverable and the grounded boat is not, you should pass the towline to the grounded boat.
- Select an appropriately strong tow line. Use double-braided or braid-on-braid line. Never use three-strand twisted nylon; it has too much elasticity and can snap back dangerously.
- Select an appropriate attachment point. If available, fasten the towline to the forward tow pylon of the towing boat. Otherwise fasten tow line to stern tow point. Fastening to the stern tow point will restrict maneuverability of the towing boat.
- If possible, use a bridle.
- Move slowly to prevent sudden strain on slack line.
- Proceed at slow speed.
- Avoid abrupt changes in throttle as that may cause the tow line to slacken and jerk tight. Sudden strain or jerking the line causes excessive tow line forces which may part the line. Keep slack out of the tow line, but if it occurs proceed slowly to again take up the strain on the line and avoid sudden jerks in the line.
- Be ready to cast loose or cut the line if the towing situation becomes hazardous.

Vessel Being Towed

- Attach the towline to the bow eye.
- If it is necessary to be towed after being freed, keep someone at the wheel to steer.

Both Vessels

- If you attach the towline to a fitting, be sure the fitting is fastened with a through bolt and is reinforced on the underside.
- Keep lines clear of propellers on both boats.
- Keep hands and feet clear of the other boat. Do not get caught or pinched between the two boats as severe injury could occur.
- Never hold a towline after it is pulled taut.



quick reference guide

At press time, up-to-date overhead images of all boats were not available. However, the designation of component locations reflects actual 2024 model locations.

Weight capacities shown reflect the best-available information at press time. Please check the weight capacity affixed to the boat to determine actual allowable total additional weight, including ballast, that can be added to the boat.

RECOMMENDED SEATING

A245

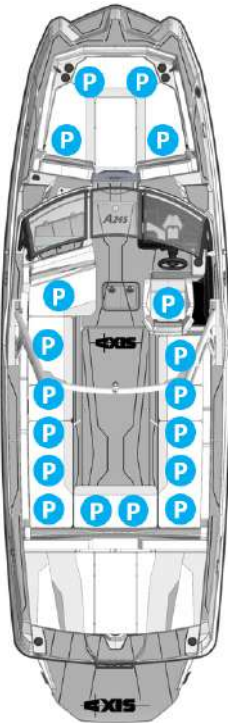

A245 CE Category C

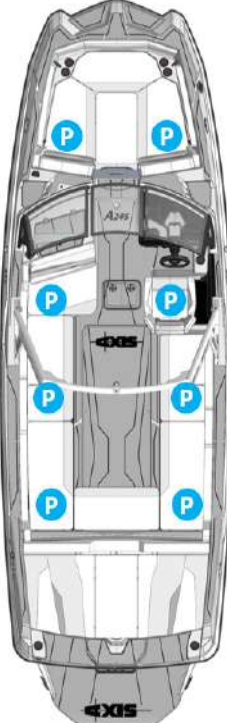

A20



A225

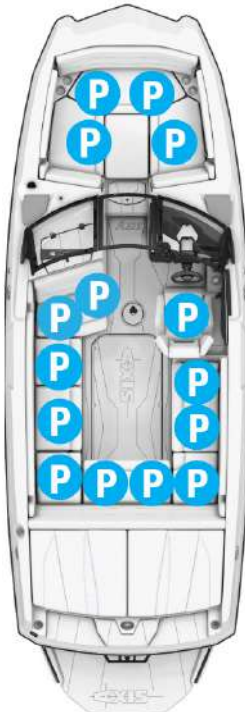

T250

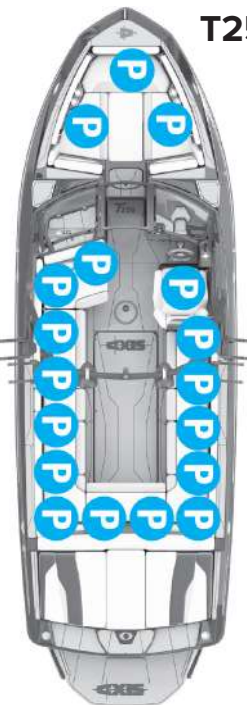

T250 CE Category C

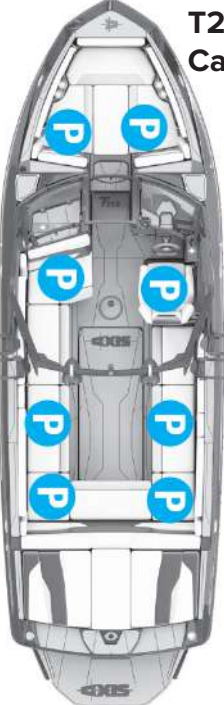

T220

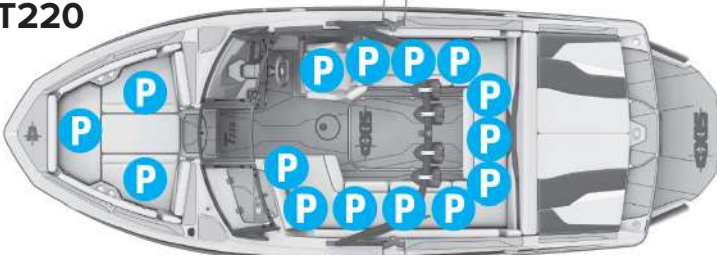

T235

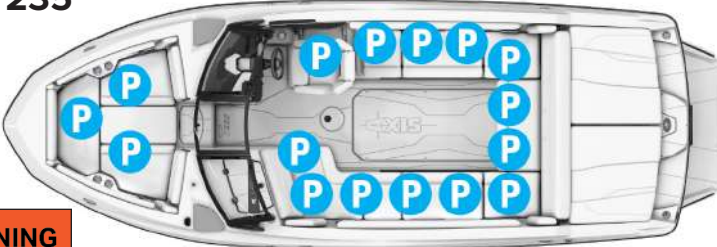

WARNING

DO NOT overload the boat. Overloading or uneven loading can cause loss of control, capsizing, or swamping, which may lead to death or serious injury. Adhere to the load capacity plate restrictions and always account for persons, gear, and all non-factory-installed ballast or other equipment.



A20

Specifications

Length:	20' / 6.10 m	Weight:	3,500 lbs / 1,588 kg
Length (with Platform):	22'2" / 6.75 m	Hull Type:	Wake Plus
Beam:	98" / 2.49 m	Capacity:	11 people total (2 in bow)
Draft:	27" / 0.69 m		1,551 lbs / 704 kg, including people
Fuel:	42 gal / 159 L		350 lbs / 159 kg maximum in bow

Storage

Under bow seating except when optional bow tank installed; under observer seat; under interior seating; watertight box below throttle.

1 — Amp

(Inside panel adjacent to observer seat)

2 — Glove Box

(Includes 12-volt charger, USB audio-only port, aux audio port)

3 — Battery ON-OFF*

(Inside panel beneath observer seat)

4 — Batteries

(In bow compartment under seating)

5 — Cleat*

6 — Center Drain Plug

(Under floor—accessed via center pie plate)

7 — Heater Vents*

(In lounge area)

8 — Fuel Fill

(Exterior port side)

9 — Surf Pipe (Engine Exhaust)

(Beneath swim board)

10 — Transom Drain Plug

(Beneath swim board)

11 — Stereo Remote*

(On transom)

12 — Transom Tow Eye

(Center transom)

13 — Swim Board

14 — Underwater Lights, Auto-Set Wedge, Surf Gate, and Power Wedge*

(All located beneath swim board)

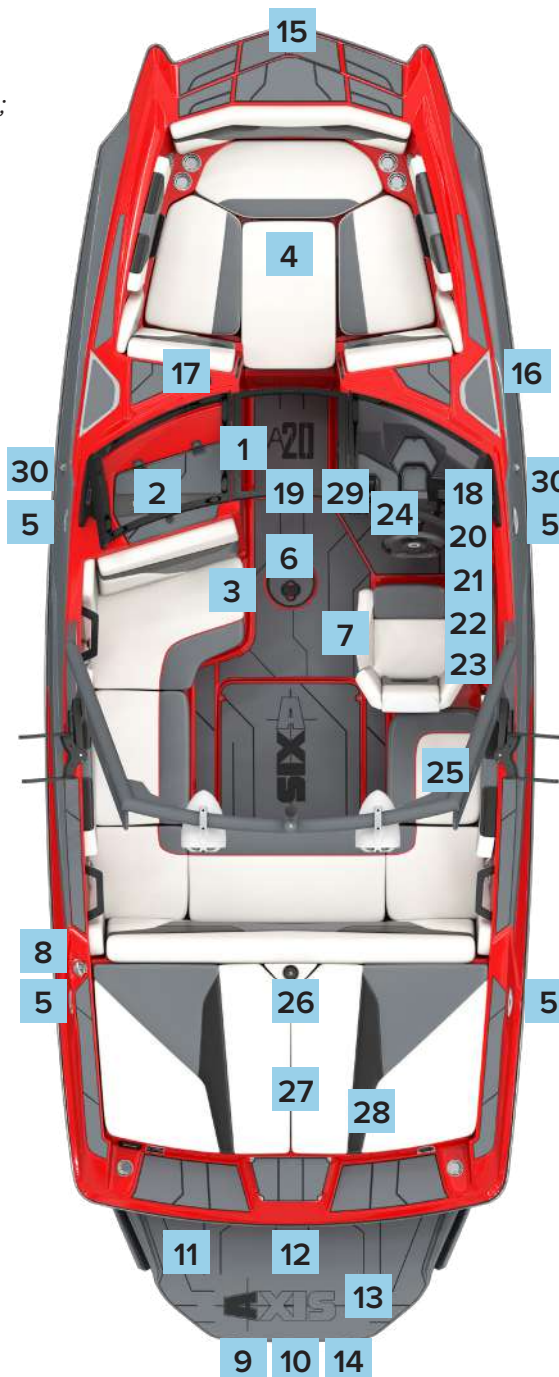

Tower

May also include tower accessories such as Wet Sounds speakers and amps; tow attachment, lights, mirror, and racks.

15 — Docking Lights*

16 — Thru-Hull Outlets

(Bilge and ballast; additional outlets aft port, starboard, and transom)

17 — Zero Off GPS Puck*

(Top of instrument panel)

18 — Heater*

(Beneath shifter panel)

19 — Adjustable Mirror*

(Mounted to windshield or tower)

20 — Emergency Safety Stop Switch

21 — Shift/Throttle Control

22 — Circuit Breaker Panel
(Beneath shifter/throttle control)

23 — Fire Extinguisher Indicator*
(On side panel)

24 — Subwoofer*

25 — Removable Cooler*

26 — Ski Pylon

(Center adjacent to engine compartment)

27 — Engine Compartment

(V-Drive—located aft)

28 — Automatic Fire Extinguisher*
(Engine compartment)

29 — Wireless Charging Phone Holder*

30 — Navigation Light

* Where equipped.



A225

Specifications

Length:	22'5" / 6.83 m	Weight:	4,900 lbs / 2,223 kg
Length (with Platform):	24'7" / 7.49 m	Hull Type:	Wake Plus
Beam:	102" / 2.59 m	Capacity:	15 people total (4 in bow)
Draft:	27" / 0.69 m		2,115 lbs / 959 kg, including people
Fuel:	56 gal / 212 L		600 lbs / 272 kg maximum in bow

Storage

Under bow seating except when optional bow tank installed; under observer seat; under interior seating; watertight box below throttle.

1 — Amp

(Inside panel adjacent to observer seat)

2 — Glove Box

(Includes 12-volt charger, USB audio-only port, aux audio port)

3 — Battery ON-OFF*

(Inside panel beneath observer seat)

4 — Batteries

(In bow compartment under seating)

5 — Cleat*

6 — Center Drain Plug

(Under floor—accessed via center pie plate)

7 — Heater Vents*

(In lounge area)

8 — Fuel Fill

(Exterior port side)

9 — Surf Pipe (Engine Exhaust)

(Beneath swim board)

10 — Transom Drain Plug

(Beneath swim board)

11 — Stereo Remote*

(On transom)

12 — Transom Tow Eye

(Center transom)

13 — Swim Board

14 — Underwater Lights, Auto-Set Wedge, Surf Gate, and Power Wedge*

(All located beneath swim board)

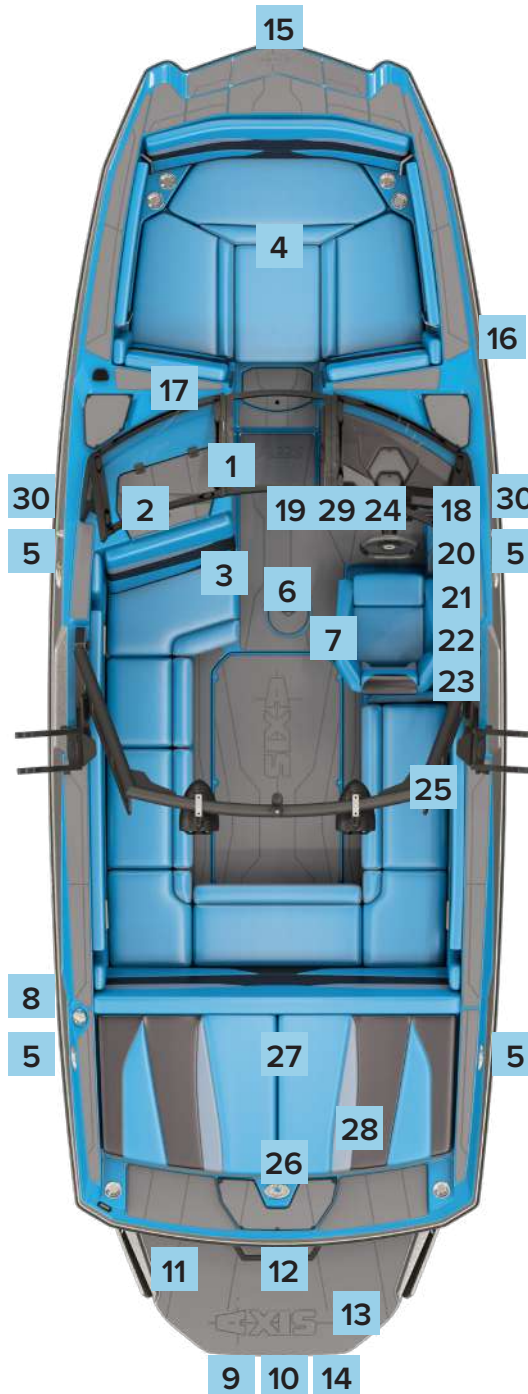

Tower

May also include tower accessories such as Wet Sounds speakers and amps; tow attachment, lights, mirror, and racks.

15 — Docking Lights*

16 — Thru-Hull Outlets

(Bilge and ballast; additional outlets aft port, starboard, and transom)

17 — Zero Off GPS Puck*

(Top of instrument panel)

18 — Heater*

(Beneath shifter panel)

19 — Adjustable Mirror*

(Mounted to windshield or tower)

20 — Emergency Safety Stop Switch

21 — Shift/Throttle Control

22 — Circuit Breaker Panel

(Beneath shifter/throttle control)

23 — Fire Extinguisher Indicator*

(On side panel)

24 — Subwoofer*

25 — Removable Cooler*

26 — Ski Pylon

(Center adjacent to engine compartment)

27 — Engine Compartment

(V-Drive—located aft)

28 — Automatic Fire Extinguisher*

(Engine compartment)

29 — Wireless Charging Phone Holder*

30 — Navigation Light

* Where equipped.



A245

Specifications

Length: 24'5" / 7.45 m
Length (with Platform): 26'7" / 8.12 m
Beam: 102" / 2.59 m
Draft: 32" / 0.81 m
Fuel: 94 gal / 355.8 L

Weight: 5,500 lbs / 2,495 kg
Hull Type: Wake Plus
Capacity: 18 people total (4 in bow)
 2,538 lbs / 1,151 kg, including people
 600 lbs / 272 kg maximum in bow

Storage

Under bow seating except when optional bow tank installed; under observer seat; under interior seating; watertight box below throttle.

1 — Amp

(Inside panel adjacent to observer seat)

2 — Glove Box

(Includes 12-volt charger, USB audio-only port, aux audio port)

3 — Battery ON-OFF*

(Inside panel beneath observer seat)

4 — Batteries

(In bow compartment under seating)

5 — Cleat*

6 — Center Drain Plug

(Under floor—accessed via center pie plate)

7 — Heater Vents*

(In lounge area)

8 — Fuel Fill

(Exterior port side)

9 — Surf Pipe (Engine Exhaust)

(Beneath swim board)

10 — Transom Drain Plug

(Beneath swim board)

11 — Stereo Remote*

(On transom)

12 — Transom Tow Eye

(Center transom)

13 — Swim Board

14 — Underwater Lights, Auto-Set Wedge, Surf Gate, and Power Wedge*

(All located beneath swim board)

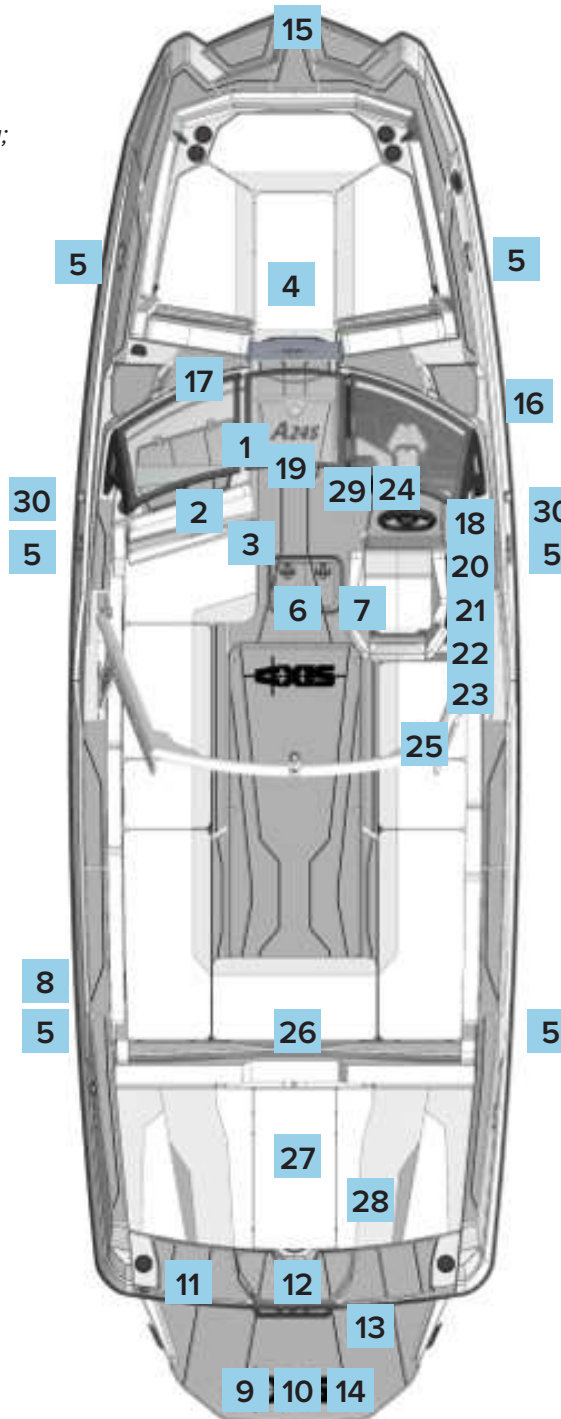

Tower

May also include tower accessories such as Wet Sounds speakers and amps; tow attachment, lights, mirror, and racks.

15 — Docking Lights*

16 — Thru-Hull Outlets

(Bilge and ballast; additional outlets aft port, starboard, and transom)

17 — Zero Off GPS Puck*

(Top of instrument panel)

18 — Heater*

(Beneath shifter panel)

19 — Adjustable Mirror*

(Mounted to windshield or tower)

20 — Emergency Safety Stop Switch

21 — Shift/Throttle Control

22 — Circuit Breaker Panel

(Beneath shifter/throttle control)

23 — Fire Extinguisher Indicator*

(On side panel)

24 — Subwoofer*

25 — Removable Cooler*

26 — Ski Pylon

(Center adjacent to engine compartment)

27 — Engine Compartment

(V-Drive—located aft)

28 — Automatic Fire Extinguisher*

(Engine compartment)

29 — Wireless Charging Phone Holder*

30 — Navigation Light

* Where equipped.



T220

Specifications

Length: 21'11" / 6.68 m
Length (with Platform): 24'1" / 7.31 m
Beam: 102" / 2.59 m
Draft: 27" / 0.69 m
Fuel: 58 gal / 219 L

Weight: 4,850 lbs / 2,200 kg
Hull Type: Wake Plus
Capacity: 15 people total (3 in bow)
 2,115 lbs / 959 kg, including people
 500 lbs, 227 kg maximum in bow

Storage

Under bow seating except when optional bow tank installed; under observer seat; under interior seating; watertight box below throttle.

1 — Amp

(Inside panel adjacent to observer seat)

2 — Glove Box

(Includes 12-volt charger, USB audio-only port, aux audio port)

3 — Battery ON-OFF*

(Inside panel beneath observer seat)

4 — Batteries

(In bow compartment under seating)

5 — Cleat*

6 — Center Drain Plug

(Under floor—accessed via center pie plate)

7 — Heater Vents*

(In lounge area)

8 — Fuel Fill

(Exterior port side)

9 — Surf Pipe (Engine Exhaust)

(Beneath swim board)

10 — Transom Drain Plug

(Beneath swim board)

11 — Stereo Remote*

(On transom)

12 — Transom Tow Eye

(Center transom)

13 — Swim Board

14 — Underwater Lights, Auto-Set Wedge, Surf Gate, and Power Wedge*

(All located beneath swim board)

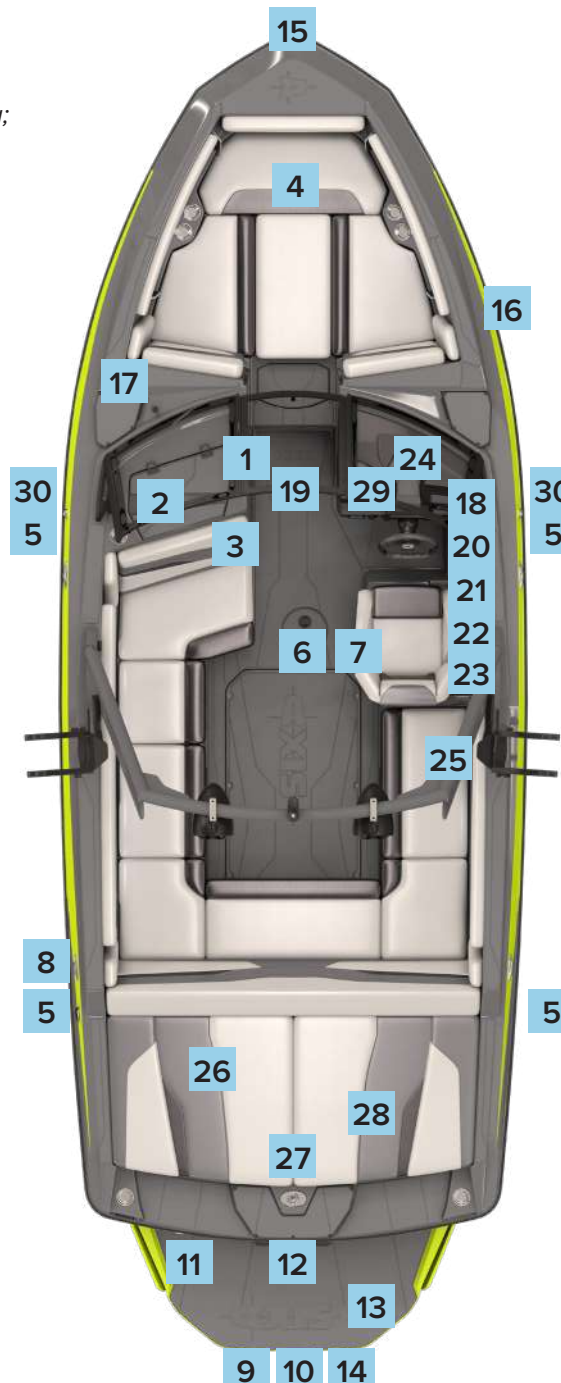

Tower

May also include tower accessories such as Wet Sounds speakers and amps; tow attachment, lights, mirror, and racks.

15 — Docking Lights*

16 — Thru-Hull Outlets

(Bilge and ballast; additional outlets aft port, starboard, and transom)

17 — Zero Off GPS Puck*

(Top of instrument panel)

18 — Heater*

(Beneath shifter panel)

19 — Adjustable Mirror*

(Mounted to windshield or tower)

20 — Emergency Safety Stop Switch

21 — Shift/Throttle Control

22 — Circuit Breaker Panel
(Beneath shifter/throttle control)

23 — Fire Extinguisher Indicator*
(On side panel)

24 — Subwoofer*

25 — Removable Cooler*

26 — Ski Pylon

(Center adjacent to engine compartment)

27 — Engine Compartment

(V-Drive—located aft)

28 — Automatic Fire Extinguisher*

(Engine compartment)

29 — Wireless Charging Phone Holder*

30 — Navigation Light

* Where equipped.



T235

Specifications

Length:	23'5" / 7.14 m	Weight:	5,400 lbs / 2,449 kg
Length (with Platform):	25'7" / 7.80 m	Hull Type:	Wake Plus
Beam:	102" / 2.59 m	Capacity:	16 people total (3 in bow)
Draft:	32" / 0.81 m		2,256 lbs / 1,023 kg, including people
Fuel:	66 gal / 250 L		500 lbs, 227 kg maximum in bow

Storage

Under bow seating except when optional bow tank installed; under observer seat; under interior seating; watertight box below throttle.

1 — Amp

(Inside panel adjacent to observer seat)

2 — Glove Box

(Includes 12-volt charger, USB audio-only port, aux audio port)

3 — Battery ON-OFF*

(Inside panel beneath observer seat)

4 — Batteries

(In bow compartment under seating)

5 — Cleat*

6 — Center Drain Plug

(Under floor—accessed via center pie plate)

7 — Heater Vents*

(In lounge area)

8 — Fuel Fill

(Exterior port side)

9 — Surf Pipe (Engine Exhaust)

(Beneath swim board)

10 — Transom Drain Plug

(Beneath swim board)

11 — Stereo Remote*

(On transom)

12 — Transom Tow Eye

(Center transom)

13 — Swim Board

14 — Underwater Lights, Auto-Set Wedge, Surf Gate, and Power Wedge*

(All located beneath swim board)

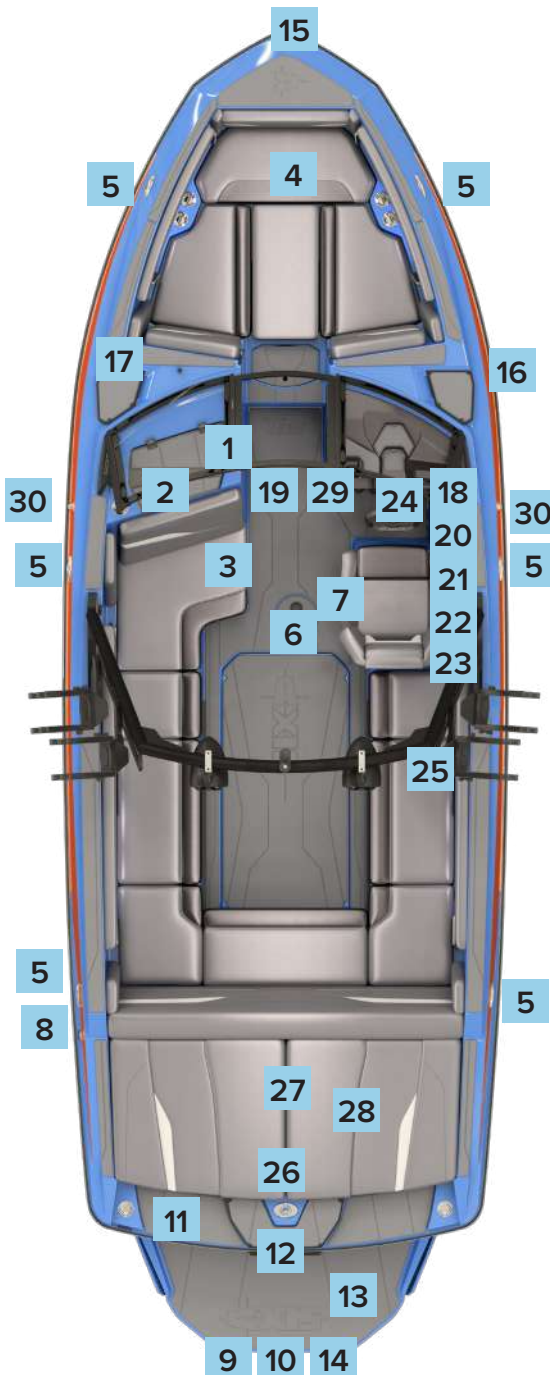

Tower

May also include tower accessories such as Wet Sounds speakers and amps; tow attachment, lights, mirror, and racks.

15 — Docking Lights*

16 — Thru-Hull Outlets

(Bilge and ballast; additional outlets aft port, starboard, and transom)

17 — Zero Off GPS Puck*

(Top of instrument panel)

18 — Heater*

(Beneath shifter panel)

19 — Adjustable Mirror*

(Mounted to windshield or tower)

20 — Emergency Safety Stop Switch

21 — Shift/Throttle Control

22 — Circuit Breaker Panel

(Beneath shifter/throttle control)

23 — Fire Extinguisher Indicator*

(On side panel)

24 — Subwoofer*

25 — Removable Cooler*

26 — Ski Pylon

(Center adjacent to engine compartment)

27 — Engine Compartment

(V-Drive—located aft)

28 — Automatic Fire Extinguisher*

(Engine compartment)

29 — Wireless Charging Phone Holder*

30 — Navigation Light

* Where equipped.



T250

Specifications

Length:	25' / 7.62 m	Weight:	5,500 lbs / 2,495 kg
Length (with Platform):	27'2" / 8.28 m	Hull Type:	Wake Plus
Beam:	102" / 2.59 m	Capacity:	18 people total (3 in bow)
Draft:	32" / 0.81 m		2,538 lbs / 1,151 kg, including people
Fuel:	94 gal / 355.8 L		500 lbs, 227 kg maximum in bow

Storage

Under bow seating except when optional bow tank installed; under observer seat; under interior seating; watertight box below throttle.

1 — Amp

(Inside panel adjacent to observer seat)

2 — Glove Box

(Includes 12-volt charger, USB audio-only port, aux audio port)

3 — Battery ON-OFF*

(Inside panel beneath observer seat)

4 — Batteries

(In bow compartment under seating)

5 — Cleat*

6 — Center Drain Plug

(Under floor—accessed via center pie plate)

7 — Heater Vents*

(In lounge area)

8 — Fuel Fill

(Exterior port side)

9 — Surf Pipe (Engine Exhaust)

(Beneath swim board)

10 — Transom Drain Plug

(Beneath swim board)

11 — Stereo Remote*

(On transom)

12 — Transom Tow Eye

(Center transom)

13 — Swim Board

14 — Underwater Lights, Auto-Set Wedge, Surf Gate, and Power Wedge*

(All located beneath swim board)

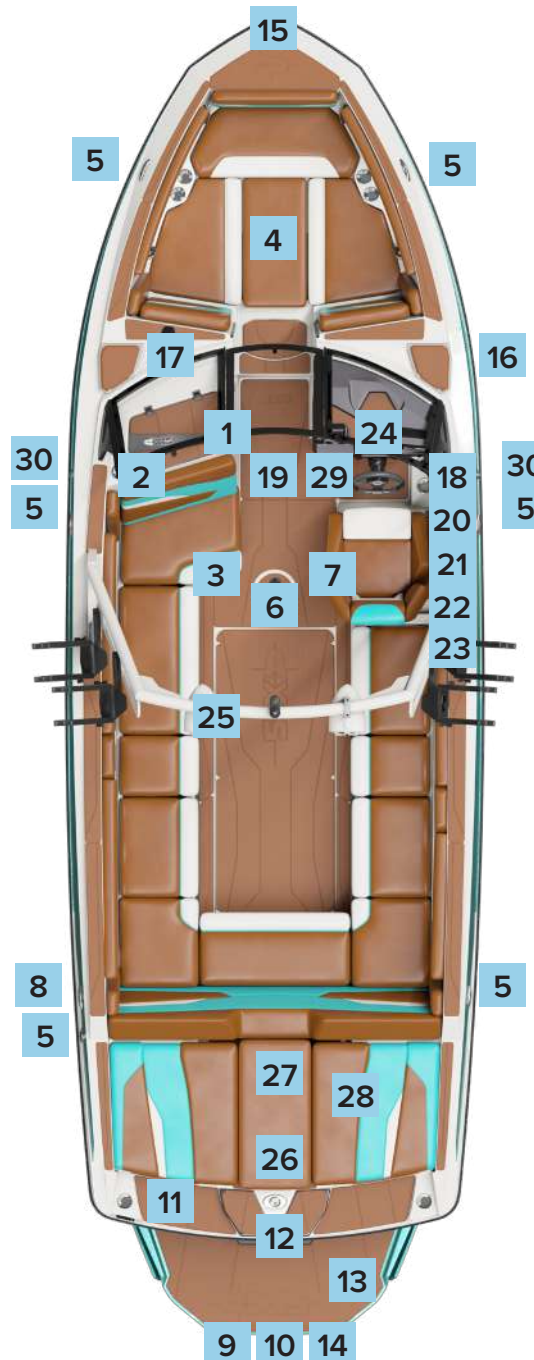

Tower

May also include tower accessories such as Wet Sounds speakers and amps; tow attachment, lights, mirror, and racks.

15 — Docking Lights*

16 — Thru-Hull Outlets

(Bilge and ballast; additional outlets aft port, starboard, and transom)

17 — Zero Off GPS Puck*

(Top of instrument panel)

18 — Heater*

(Beneath shifter panel)

19 — Adjustable Mirror*

(Mounted to windshield or tower)

20 — Emergency Safety Stop Switch

21 — Shift/Throttle Control

22 — Circuit Breaker Panel

(Beneath shifter/throttle control)

23 — Fire Extinguisher Indicator*

(On side panel)

24 — Subwoofer*

25 — Removable Cooler*

26 — Ski Pylon

(Center adjacent to engine compartment)

27 — Engine Compartment

(V-Drive—located aft)

28 — Automatic Fire Extinguisher*

(Engine compartment)

29 — Wireless Charging Phone Holder*

30 — Navigation Light

* Where equipped.



dashes and video screens

THE AXIS INSTRUMENT PANEL

The Axis instrument panel dash features include:

- 7" Garmin Display
- Horn/Start-Stop Button Pad
- Power Button
- Phone Holder
- Sport Dash Keypad (optional)
- Radio Remote (optional)
- Wireless Charging Phone Holder (optional)

The functionality of the Axis dash will be explained in this section. Additional information about certain aspects of the controls will also be discussed in further detail in other sections of this Owner's Manual. Be sure to read the entire manual before attempting to operate the controls.

7" Garmin Display

The Axis instrument panel features a 7" Garmin display that is located to the right of the steering wheel. It provides real-time information about important systems on the vessel. This display communicates to the various devices and Engine Control Module (ECM) over the CAN network.

There are seven buttons on the right side of the display.

Day/Night Button

Pressing this button will cycle the screen brightness between *Day Mode*, *Night Mode*, and *Sleep Mode*.

Screen Brightness Buttons

Press the big light bulb button to increase the screen brightness. Press the small light bulb button to decrease the screen brightness.

Navigational Buttons

Watersports Button

Press the *Watersports* button to navigate the screen to the *Watersports* page.

Controls Button

Press the *Controls* button to navigate the screen to the *Controls* page.

Gauges Button

Press the *Gauge* button to navigate the screen to the *Gauge* page.

Settings Button

Press the *Settings* button to navigate the screen to the *Settings* page.

NOTE: *Swiping side to side on the screen will navigate between the Watersports, Controls, and Gauges pages.*



Watersports Screen

The Watersports screen will show the driver the information about the *Ballast System*, *Surf Gates*, *Wedge*, and *Cruise Control*.

Warning Icons

There are two warning icons that can be visible on the screen if there is an active alarm/fault on the vessel or on the engine. The *Check Engine* icon is in the bottom right corner of the display. If the engine control module is reporting an active alarm, the icon will be visible. Pressing this icon will navigate the screen to *Engine Alarms* page.

The *System Warning* icon is in the button left corner of the display. If one of the following alarms is active this icon will be visible:



- Low Battery Voltage
- Low Fuel
- Shallow Depth Alarm
- Auto Bilge
- Wedge in Drag
- High Speed Wedge Down
- High Speed Surf Gate
- Surf Gate Left Fault
- Surf Gate Right Fault
- Power Module Overcurrent

Pressing the *System Warning* icon will navigate the screen to the *Systems Alarm* page.



Cruise Control

The engine must be running and in Neutral for the *Cruise Control* system to engage.

After disabling *Cruise Control*, the boat will hold the programmed speed until you bring the throttle back to Neutral. Failure to remain aware of your surroundings when disabling *Cruise Control* could result in damage to the vessel and/or result in serious personal injury.



WARNING

You are responsible for the safe and prudent operation of your vessel. Cruise Control is a tool that enhances your capability to operate your boat. Cruise Control does not steer the vessel for you. Cruise Control does not relieve you of the responsibility of safely operating your boat. Avoid navigational hazards and never leave the helm unattended.

- The ON/OFF button in the center of the *Watersports* page is for enabling and disabling the *Cruise Control* system. When the *Cruise Control* system is OFF, all the *Cruise Control* information will be hidden. When *Cruise Control* is enabled, the *Set Speed*, *Cruise Control Adjustment*, and *Throttle Information* will be visible.
- The *Cruise Control Set Speed* shows the speed being commanded. The *Set Speed* can be set between five (5.0) mph to sixty (60) mph (or metric equivalent).
- The *Cruise Set Speed Adjustment* buttons will increase or decrease the *Set Speed* in one-tenth (0.1) mph/kph increments.
- The *Throttle Position* will show the driver the current position of the throttle that the engine is receiving. When the engine begins to govern the speed, a box will appear around the *Throttle Position Indicator* to highlight the desired range. If the *Throttle Position Indicator* is in the box, the box will be **Green**. If the *Throttle Position Indicator* moves above or below, the box will change to **Red**.



Ballast System

The *Ballast Controls* allow the driver to control the amount of water in the boat's ballast tanks/bags. The driver can select either one or multiple tanks, and then select the action for those tanks (*Fill/Drain/Stop*). The tanks will have a *Fill/Drain Timer*.

- Bow (optional)—10 minutes.
- Center—15 minutes.
- Port—15 minutes.
- Starboard—15 minutes.

Surf Gates

The *Surf Gate Controls* informs the driver of the current position of the Surf Gates and allows for their control. The controls will indicate if the Surf Gates are in the *Left*, *Center*, or *Right* position. Surf Gates will only extend and retract when the vessel speed is between nine (9.0) mph and fifteen (15.0) mph (or metric equivalent).

Wedge

The *Wedge Controls* let the driver know the current position for the Wedge and, if equipped, control the Power Wedge. When a manual Wedge is installed on the vessel, the *Watersports* page will show the status of the Wedge: *Stowed* or *Deployed*.



When the Power Wedge is installed, the *Power Wedge Status* will show if the Wedge is in *Lift*, *Wedge 1*, *Wedge 2*, *Wedge 3*, *Wedge 4*, *Wedge 5*, *Wedge 6* or *Stow*. It will also allow the driver to control what position the Wedge is in. A **Blue** highlighted position shows the selected position. A solid **Blue** position shows the actual position of the Wedge.

NOTE: When the *Vessel Speed* is between one (1.0) mph and ten (10.0) mph (1 kph and 16 kph) the Power Wedge can be moved to or from the *Stow* position. If the Power Wedge is deployed (*Lift* to *Wedge 6*), the *Power Wedge Position* can be changed when the *Vessel Speed* is below twenty-six (26.0) mph (41 kph). When the *Vessel Speed* is above 26.0 mph (41 kph), the Power Wedge is locked in place.

Auto-Wedge

Auto-Wedge is the automatic control of the Power Wedge to help the boat, reduce drag and get on plane. When *Auto-Wedge* is ON and the *Cruise Control Set Speed* is greater than sixteen (16.0) mph (or metric equivalent), the Wedge will move to *Lift*. The *Desired Wedge Position* will remain highlighted. When the vessel reaches 85% of the *Set Speed*, the Wedge will move to the *Desired Position*. If the boat drops more than 25% from the *Set Speed*, the Power Wedge will move back to the *Lift* position.

Presets

The *Presets* button will bring up a new menu to allow the Driver to setup the boat for various Water Sport activities. There are 5 pre-programmed Presets that cannot be changed: *Surf Left*, *Surf Right*, *Wakeboard Beginner*, *Wakeboard Advanced*, and *Go Home*.

Controls Screen

The *Lighting and Controls* screen allows the driver to control the lights and other devices installed on the vessel. There is also a boat image that shows where these lights or devices are at when turned ON.

- Press the *Bilge* button to turn the **Bilge** pumps ON and OFF.
- Press the *Heater* button to cycle the **Heater** between HIGH, LOW, and OFF.
- Press the *Blower* button to turn the **Blower** ON and OFF.
- Press the *Docking Lt* button to turn the **Docking Lights** ON and OFF.
- Press the *Nav Lt* button to turn the **Navigation Lights** ON and OFF.
- Press the *Anch Lt* button to turn the **Anchor Lights** ON and OFF.
- Press the *Int Lt* button to turn the **Interior Lights** ON and OFF.
- Press the *Seat Lt* button to turn the **Under Seat Lights** ON and OFF.
- Press the *H2O* button to turn the **Underwater Lights** ON and OFF.



Gauge Screen

The *Gauge* screen will show the driver vital information that pertains to the vessel and the engine.

- Vessel Speed (Digital readout and analog gauge)
- Cruise Control Set Speed (Digital readout and indicator on vessel speed analog gauge)
- Engine RPM (Digital readout and analog gauge)
- Battery Voltage
- Depth
- Fuel Level (Analog gauge)
- Fuel Pressure
- Transmission Temperature
- Coolant Temperature
- Intake Air Temperature

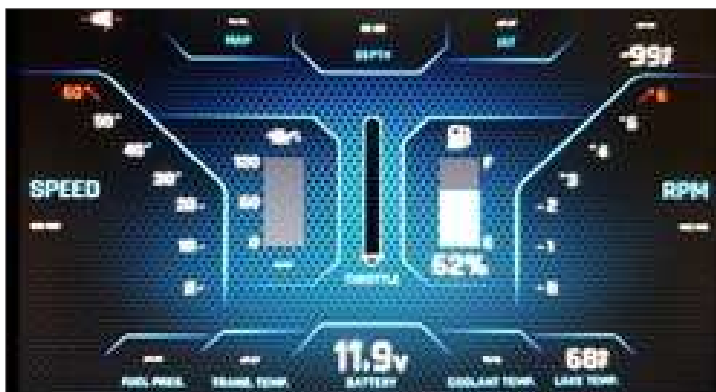

- Manifold Air Pressure
- Engine Hours
- Air Temperature
- Water Temperature
- Time of Day (optional)
- Cardinal Direction (optional)

Settings Screen

If the driver pressed the gear button on the display, it brings up the *Settings Menu*.

The *Main Setting* screen has four options to choose from: *System*; *Calibration*; *Boat Configuration*; and *Diagnostics*.

System Settings

The *System Settings Menu* has two buttons; one button for *Software* and one for *Language* selection.

Software

The *Software* page will provide information about the device and the software version. It also allows the driver to reset the device settings to factory default values.

Software updates will be performed on the page. Upload the software package to an empty USB drive and insert it into the USB port under the dash. Navigate to the *Software* page. Once the system recognizes the update file, a button will appear that says *Update*. Pressing this button will bring up a pop-up confirming that you want to perform a software update. Pressing *YES* will begin the software update process. The display will show the status of the update.



Language

The *Language* page allows the driver to change the on-screen language.

Calibration Settings

Units

Allows the driver to select either *English* or *Metric*.

Depth Alarm

Adjust the depth of the *Shallow Alarm*.

Water Temperature Offset

This allows the operator to adjust the *Water Temperature* reading to change degree(s) Fahrenheit plus or minus.

Air Temperature Offset

This allows the operator to adjust the *Air Temperature* reading to change degree(s) Fahrenheit plus or minus.

Time

Choose from all time zones and turn ON/OFF Daylight Savings Time.

Speed/Throttle

Change the *Throttle Profile* between *Standard* and *Aggressive*.

Stereo

Select the *Auto-Volume Level*.

Boat Configuration Settings

- Controls and Lighting
- Turn on the options for accessory items
- Heater
- Docking Lights
- Underwater Lights
- Underseat Lights
- Bow Ballast

Wedge Configuration

Select between *Manual Wedge* and *Power Wedge*, and turn ON/OFF *Auto-Wedge*.



Surf Gate Transfer

Select the *Audible Transfer Tone*, and select the *Transfer Tone Volume*.

Engine Start Code

Must enter the *Start Code* to access the *Configuration* screen. After the code has been successfully entered, the driver can enable/disable the *Start Code* or change the *Start Code*.

Diagnostic Settings

Engine Diagnostics

View all the diagnostic parameters that are sent from the ECM.

Alarms

Choose between *General Alarms* and *Engine Alarms*. The *General Alarms* will be *Vessel Related* alarms, which are listed in *Alarms* later in this section of the manual. *Engine Alarms* are engine-related alarms. On the *Engine Alarms* page, the driver can choose between *Active* and *Inactive Alarms*.

System Diagnostics

View the status for the *Fuel Level*, *Lake Temperature*, *Air Temperature*, and *Bilge Statuses*. Press *CAN 1 Status* to see the devices that are connected to the CAN 1 network and their status. Press *CAN 2 Status* to see the devices that are connected to the CAN 2 network and their status.

Debug Assist

This page should be used only by authorized Axis-trained technicians.

Power Modules

See the *Input*, *Output*, and *Relay* status of each of the power modules. This page should be used only by authorized Axis-trained technicians.



ACCESSORY KEYPADS

Sport Dash Keypad

The Axis dash can contain up to two keypads, depending on what options are equipped on the boat. The first is the *Sport Dash* keypad. This keypad will allow the driver to control the following devices:

Blower

Press this button once to turn the *Blower System* ON. Press again to turn the system OFF. The LED in the button will light when the *Blower System* is ON. See *Blower System* section below for more information.

Navigation/Anchor Light

Press this button once to turn the *Navigation Lights* ON. Press again to turn the *Anchor Light* ON and the *Navigation Lights* OFF. Press a third time to turn the *Navigation Lights* and *Anchor Light* ON. Press a fourth time to turn the *Navigation Lights* and *Anchor Light* OFF. The left LED in the button will light when only the *Navigation Lights* are ON. The middle LED in the button will light when only the *Anchor Light* is ON. The right LED in the button will light when the *Navigation Lights* and *Anchor Light* are ON.

Wedge Up

Press this button once to move the *Power Wedge* up one position.

Wedge Down

Press this button once to move the *Power Wedge* down one position.

Bow Ballast Fill/Drain

Press this button once to turn the *Bow Fill Pump* ON. Press again to turn the *Bow Drain* ON and *Bow Fill Pump* OFF. Press a third time to turn the *Bow Drain Pump* OFF. The left LED in the button will light when only the *Bow Fill Pump*



is ON. The right LED in the button will light when only the *Bow Drain Pump* is ON. See *Ballast System* section below for more information.

Center Ballast Fill/Drain

Press this button once to turn the *Center Fill Pump* ON. Press again to turn the *Center Drain* ON and *Center Fill Pump* OFF. Press a third time to turn the *Center Drain Pump* OFF. The left LED in the button will light when only the *Center Fill Pump* is ON. The right LED in the button will light when only the *Center Drain Pump* is ON. See *Ballast System* section below for more information.

Port Ballast Fill/Drain

Press this button once to turn the *Port Fill Pump* ON. Press again to turn the *Port Drain* ON and *Port Fill Pump* OFF. Press a third time to turn the *Port Drain Pump* OFF. The left LED in the button will light when only the *Port Fill Pump* is ON. The right LED in the button will light when only the *Port Drain Pump* is ON. See *Ballast System* section below for more information.

Starboard Ballast Fill/Drain

Press this button once to turn the *Starboard Fill Pump* ON. Press again to turn the *Starboard Drain* ON and *Starboard Fill Pump* OFF. Press a third time to turn the *Starboard Drain Pump* OFF. The left LED in the button will light when only the *Starboard Fill Pump* is ON. The right LED in the button will light when only the *Starboard Drain Pump* is ON. See *Ballast System* section below for more information.

Surf Left

Press this button once to move the selected *Surf Position* to *Surf Left*.

Surf Center

Press this button once to move the selected *Surf Position* to *Surf Center*.

Surf Right

Press this button once to move the selected *Surf Position* to *Surf Right*.

Go Home

Press this button once to enable *Go Home* mode.

- *Ballast Tanks* will begin to drain.
- *Surf Gates* will be commanded to the *Center Position*.
- *Power Wedge* desired position will be set to *Stow*.
- *Cruise Control* will be turned OFF.

Cruise Knob

Spinning the *Cruise Knob* clockwise will increase the *Cruise Control Set Speed* in 0.1 increments. Spinning the *Cruise Knob* counterclockwise will decrease the *Cruise Control Set Speed* in 0.1 increments.

- Pressing the knob once will switch the *Cruise Control* state.
- If *Cruise Control* is ON, it will turn *Cruise Control* OFF.
- If *Cruise Control* is OFF, it will turn *Cruise Control* ON.

Radio Remote

If the boat is equipped with *Sound Pack 1* or greater, the dash will have a radio remote installed for controlling the stereo. Stereo operation information is provided by the manufacturer in a separate document. Where equipped Axis boats may also have a stereo remote, providing additional access to functionality.

Power Button, Horn Button and Start-Stop Button

Located on the lower right side of the Axis dash is the *Power Button*, *Horn Button*, and *Start-Stop Button* (see *Starting and Operation* in the chapter *Get Ready* in this manual for instruction on how to use the key and operating with the emergency safety stop switch).

The *Power Button* is a **Black** button with a power symbol. The button will control the *Ignition Power* to the dash and supporting devices. When the button is ON, there will be a **Blue** back light to show that the ignition power is ON.



The *Horn Button* is a **Red** button with a horn symbol. Depress this red button to sound the horn. It will sound only if it is pressed. This is a safety feature to alert other boaters of your approximate location.

The *Start-Stop Button* is a **Black** button that says *Start-Stop*. The button will control the remote *Start* and *Stop* of the engine. The first press of this button will bring up the *Engine Code Entry* on the 7" Display, unless disabled in the *Settings Menu*.

BASIC ELECTRICAL COMPONENTS

Circuit Breakers

All major boat circuits are protected from shorting and overload by resettable circuit breakers. If a circuit breaker becomes tripped, you should turn the battery isolator switch to the OFF position as soon as possible, then wait about one (1) minute before resetting the breaker and turning the battery switch back ON. If the circuit continues to trip, there is a problem somewhere in the system. Take the boat to an authorized Axis dealer to locate and safely correct the issue.

There are three breaker panel locations in all Axis boat models; each location is responsible for different areas of the boat and are shown in the following figures.

Driver's Helm



Under Observer's Seat



Port Rear Storage Compartment

The circuit breaker for the module that controls the Power Wedge III and Surf Gate is located on the board in the port rear closeout, adjacent to the engine compartment. If any of these systems will not operate, verify that the breaker is properly set.

If a circuit breaker continues to trip, do not hold the breaker in position to activate the electrical circuit. See an authorized Axis dealer immediately to locate and correct the issue before operating the boat.

Engine Fuse Box

In addition to the circuit breakers that control most of the electrical activity on the boat, Axis engines also have a fuse box on the engine.



LT4 Fuse Box

This fuse box aids in controlling various electronic functionality within the engine. Its purpose is to prevent electrical overload to various key electronic elements. If the fuse "kicks" off, it tends to be a signal that certain vital operations have experienced an electrical surge that could have caused significant damage to the system if the fuse had not blown.

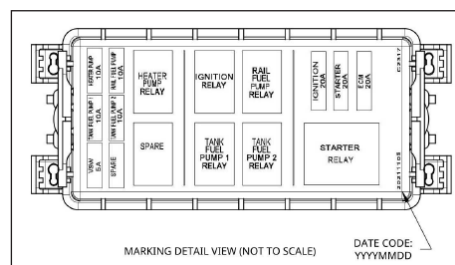

M5/M6 Fuse Box Diagram

The fuse box can be opened to replace the fuse. (Unlike circuit breakers that "trip," a fuse must be replaced.) When possible, have this function serviced by an authorized Axis dealer, who can check the entire system to determine the source or cause of the fuse malfunction. If the fuse blows during an outing, never pry or force open the box. The top should pop off the housing with minimal effort. Inside the housing will be several fuses; the



sizes are denoted on the top of the fuse. There is also a Primary and Secondary fuse box under the dash that contains fuses. Each box has a labeled/detailed picture of location, fuse size, and which circuit it protects.

If a fuse blows repeatedly, it is symptomatic of a recurring issue that must be addressed. Such repair should be undertaken by your authorized Axis dealer.

Electrical Harnesses and Wiring

Your Axis boat is equipped with several electrical harnesses providing power within the drivetrain and to various ancillary functions of the boat. Due to the complexity of the boat's wiring, much of which is inaccessible inside the hull and under the deck, any time an issue is suspected involving the wiring or any of the harnesses, the boat owner is strongly encouraged to have the boat serviced by an authorized Axis dealer.

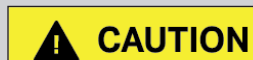

Electrical wiring or harness issues should always be addressed by an authorized Axis dealer. Alteration of wiring from the original Axis design could result in shock hazard, potential spark that could lead to fire, or other dangerous situations. Any disruption of the wiring from its original plan and resultant damage to components or the boat is not covered under warranty. Individuals could also be injured by such error.

Batteries

Axis offers batteries as an option. If the boat owner chooses to equip the boat with batteries of his/her own choosing, there are certain requirements for starting and the operation of the boat, which is addressed later in this section. Please review that information as it can be critical to avoiding a situation in which a battery(ies) is completely drained and leaves boaters stranded away from shore, or which can cause significant damage to the recharging alternator.

Batteries are in the bow in all models and all configurations.

IMPORTANT NOTE FOR ALL BATTERY SYSTEMS: Note that the bilge pumps will continue to pull power, even when the isolator switch is in the OFF position on the boats so equipped. **This is to reduce the likelihood of swamping or sinking of the boat.** Bear in mind that for the bilge systems to work, the battery will necessarily be drained, and eventually it will cause the battery to run out of charge. Therefore, under these circumstances, the boat should periodically be started, and the engine run for a sufficient time to allow the voltmeter reading to return to the desired range of at least 13.6 volts. How often and how long the engine should be run to recharge the battery will vary depending on the type, brand, and age of the batteries. The boat owner should frequently recharge the battery until determining the approximate time in which the battery retains sufficient charge to operate the bilge system, and also to start the engine.

Axis boats are equipped with one of the systems explained below:

- **Two-Position Isolator System (ON/OFF).** The most basic battery system that allows the operator to turn a single or dual battery bank ON or OFF. The advantage to this system is that it can allow the battery to cease operation by turning the switch off and retain residual energy within the battery until needed.
- **Four-Position Isolator System (OFF-BAT1-BAT2-COMBINE).** This battery system allows the operator to turn both battery banks ON or OFF or to combine. The advantage to this system is that it allows the operator to direct power draw from each bank individually or combine both banks to take advantage of a larger battery system when needed. It's important to be aware of any continuous discharging to the system when set to COMBINE, and make appropriate action to switch to an isolated battery bank if voltage starts to deteriorate. If the switch is left in the COMBINE state, it's possible to drain both battery banks entirely and possibly lead to a stranded situation.



The numbers 1, 1+2, and 2 refer to the two batteries that you purchase for the boat. The batteries are in battery holders in the bow. As part of the routine maintenance, boat owners should routinely verify that the batteries are secure within the holders. There are four markings on the knob: OFF, 1, 2, and 1+2.

OFF means that all power to both batteries is shut down. The battery will not be able to recharge while in the OFF



position. This is the appropriate setting for periods of inactivity with the boat. When the boat remains in the water, the bilge pumps will still be powered by the battery in case it becomes necessary for the bilge pumps to pump out residual water in the bilge system. See above description of how the bilge system operates automatically.

Battery 1 is the starting battery or engine battery. It should be rated at least 800 cold cranking amps (CCA), and an AGM Battery is preferable.

Battery 2 is the house battery and is used to run the electronics. The house battery should have a rating of at least 75 Amp Hours, and an AGM Battery is preferable.

When starting the engine, the battery switch should be set to 1. This allows the engine to pull power from the engine battery.

The switch should be set on 1+2 when the boat is running to charge the engine battery and the house battery. When listening to music without the engine running, set it to 2 so the engine battery is not drained.

If the engine battery is sluggish or is struggling to start the engine, turning to 1+2 can be helpful in providing sufficient power to start the engine and begin the recharging process.

All systems: If the battery has insufficient charge, use only a battery charger to recharge the battery, or remove the battery and take it to an authorized Axis dealer or auto parts store that has the appropriate facilities to safely recharge the battery. If the boat is out of the water and/or in storage, OFF is the setting for the battery switch.

Axis does not recommend the purchase and use of battery chargers other than the battery charger offered as an option through your authorized Axis dealer. The battery charger offered by your dealer has been selected as best for meeting the requirements of batteries.

NOTICE

If the battery switch is in the OFF position, the automatic bilge system will continue to operate. This could result in a drain on the battery after an extended period. The only way the automatic bilge system is OFF is to disconnect the battery cables from the batteries or remove the batteries. Unless the boat has been removed from the water, Axis does not recommend disconnecting the automatic bilge system.

Use marine-rated batteries only! Never use automotive batteries as they do not have the additional protection necessary to function in a boat where water and humidity are always factors.

! DANGER

If it becomes necessary to recharge a battery from an external source, DO NOT attempt to charge using automotive battery cables or use another boat battery as the source for charging. Some amounts of hydrogen gas are emitted during the charging process. This can be very dangerous. It is critical to keep all sparks, including lit cigarettes, lighters or any type of flame, well away from a charging battery. Use the optional battery charger sold by authorized Axis dealers, or a similar aftermarket battery charger. Using the wrong type of charging procedure or improperly charging a battery can result in an explosion and/or fire that could lead to serious injury or death.

! WARNING

Inside the battery is an electrolyte fluid that allows the chemical reaction to provide power. The fluid is comprised of several components, one of which is sulfuric acid. As with most acids, this is caustic and corrosive. If the acid comes in contact with skin, immediately flush the area with copious amounts of fresh, clean water. Follow up with medical assistance.

Batteries used in tandem must always use the same chemistry! Mixing battery types can cause damage to the electrical system, which is not covered under warranty.

! CAUTION

Failure to use marine-rated batteries in your boat could result in electrical system interruptions that could strand your boat during an outing. Batteries are placed in molded containers in the bow to provide extra protection, but it is still possible for water and the high humidity associated with operation on the water to affect batteries. If a battery, even marine-rated, becomes wet, allow it to dry before trying to start the engine. Water can cause a short at the battery terminals, which would prevent operation. Note that batteries are never covered under Axis warranty. Damage to other components due to the use of inappropriate batteries or failure to properly maintain batteries is also not covered under warranty.



Connecting/Disconnecting Batteries

The posts on a battery are marked negative (-) and positive (+), one of each on top and separated by some space. The battery cables are color-coded, Black for negative and Red for positive.

Axis recommends having your authorized Axis dealer install the batteries. Consumers can perform this procedure, provided common sense safety guides the process.

If batteries have not been previously installed:

Step 1: Ensure the engine is OFF, and the battery switch is OFF on boats, where equipped.

Step 2: Place the batteries in the containers.

Step 3: Attach the positive cable to the secondary (2) battery, attaching the positive (+) cable to the positive (+) post.

Step 4: Attach the positive cable to the primary (1) battery, attaching the positive (+) cable to the positive (+) post.

Step 5: Attach the negative (-) cable to the secondary (2) battery, attaching the negative (-) cable to the negative (-) post.

Step 6: Attach the negative (-) cable to the primary (1) battery, attaching the negative (-) cable to the negative (-) post.

Step 7: A separate cable is attached between the two negative (-) posts on the (1) and (2) batteries for additional ground.

Step 8: Check that all cables are secure. Do not torque any connections; hand-tighten securely using a wrench. Never round off any of the nuts used to secure the cables. If a nut will not tighten, do not force it. Seek assistance to determine if the nut is the wrong size or some other issue exists.

If a battery requires replacement, reverse the steps above. Never replace a battery with the boat electrical system ON. Even if only one battery requires replacement, follow the steps and disconnect, then reconnect cables as directed above.



Never touch positive (+) and negative (-) posts or connections simultaneously during installation! Never attempt to install or replace batteries with the boat electrical system ON, or in the presence of gas fumes. An electrical spark caused by connection to a functional battery can cause an explosion or fire, which is likely to cause serious injury or even death. This can also cause substantial damage to the electrical system, which is not covered under warranty.

Battery Maintenance

Batteries require routine maintenance to operate properly. See the *Care and Maintenance* section of this manual for details.

Battery Charger

The charger is a three-stage electronic device that operates automatically when properly installed. There are red and green LED lights on the charger face to provide evidence that charging is occurring. When the battery or batteries are fully charged, the unit will automatically shut OFF.

The charger can be plugged into an on board socket. It can be left in place without boiling electrolytes in the battery, but Axis recommends disconnecting and storing it when not in use. If the charger ever appears to be malfunctioning, take the boat and charger to an authorized Axis dealer for troubleshooting.



DO NOT USE AUTOMOTIVE JUMPER CABLES TO START THE ENGINE. Never jump-start the boat from a vehicle on shore or another boat. The presence of water and fumes create a situation in which sparks or backfire could result in serious injury or even death.

Engine Sensors

To ensure the engine runs as designed, it is equipped with several sensors that constantly monitor engine functionality.

These sensors include: oil temperature sensor, oil pressure sensor, manifold absolute pressure (MAP), camshaft



position sensor, crankshaft position sensor, coolant temperature sensor, and knock sensor.

These sensors are inaccessible to consumers because they are located inside sealed portions of the engine. Sophisticated, expensive tools are necessary to analyze the sensor activity; therefore, if any of the sensors indicates malfunction, the boat needs to be presented to the authorized Axis dealer for diagnosis and resolution of any issues that may be present. Notice of potential malfunctions will appear on the video screen. Additionally, alarms may sound if issues arise affecting engine operation. These alarms may be visual on the video screen or may be audible alarms. Although it is possible for a sensor to be in error, it is unlikely. Experience has shown over the years that the sensors are highly accurate and offer protective warnings of malfunction that could potentially bring attention before more expensive and damaging events occur. Never ignore an alarm! Seek assistance from your authorized Axis dealer if the issue cannot be resolved or recurs.

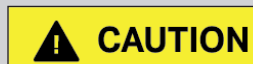

Never ignore visual or audible alarms! Consumers may be able to address the issue raised by the alarm, but if the alarm persists, cease operating the boat and seek assistance from your authorized Axis dealer. Failure to seek aid in analyzing the cause of an alarm could result in damage that is not covered under warranty. Some alarms could be for malfunctions that could also put individuals on board in potential harm.

OTHER ELECTRICAL COMPONENTS

12-Volt Receptacles

All boats have 12-volt receptacles for your convenience. Some models have more than one receptacle. Verify locations with your authorized Axis dealer. It is the responsibility of the device user to determine that the accessory is designed to be operated on a 12-volt system. If the connector will not easily and securely insert into the 12-volt receptacle, do not force it. If damage occurs to the device or the boat's electrical system by attempting to use a device that is not compatible, such damage will not be covered under warranty nor will Axis accept responsibility.

Surf Band

A waterproof Surf Band is an option for Axis models. Worn on the wrist of a wake surfer, wakeboarder, or skier, the device allows redundant control of the Surf Gates, Power Wedge, and minor cruise control adjustments. The boat operator still has primary control of the boat and can deactivate the rider controls.

The distance from the boat that the Surf Band is operational is approximately 80 feet. The signal emitted from the wristband will weaken as distance from the boat increases, but the cessation of operation will vary, depending on conditions, location, battery strength, and other factors.

To operate the Surf Band while underway:

Step 1: Place the Surf Band securely on the wrist of the non-dominant hand.

Step 2: To adjust the Power Wedge, press the UP ARROW to raise the Power Wedge. It will move one “click” for each press of the button. Press the DOWN ARROW to lower the Power Wedge.

Step 3: To adjust the Surf Gates press the LEFT ARROW (<) above the word “Surf” to surf left (increase the wave on the left, or port, side of the boat. Press the RIGHT ARROW (>) to surf right (increase the wave on the right, or starboard, side of the boat).

Step 4: To increase the speed of the boat, press the UP ARROW above the word “Speed.” To reduce speed, press the DOWN ARROW. Each press will increase or decrease the speed one (1) mph.



NOTICE

The Surf Band communicates over a commonly used radio frequency. The command signals may not be successfully sent or received when subjected to radiated interference from nearby high-powered transmitters operating on the same frequency. The possibility of interference is minimal, but it is unavoidable.

There is an LED that is underneath the rubber section of the Surf Band. If the signal LED stops flashing with a button press, or communication becomes intermittent, replace the battery.

Step 1: Rotate the battery cover counterclockwise one-eighth (1/8) of a turn with a coin or screwdriver until the cover arrow is aligned with the unlock symbol.

Step 2: Remove the battery cover and the battery.

Step 3: Assure the white O-ring cover seal remains intact.

Step 4: Replace with a Panasonic CR2016 battery, text side up.

Step 5: Reposition the battery cover and rotate clockwise one-eighth (1/8) turn to secure.

CAUTION

The Surf Band will TEMPORARILY override the driver's control of these elements of the boat operation. However, you should be aware that the driver can always resume control of all aspects at any time. Surfers should limit the amount of time spent looking at the wristband as prolonged viewing away from the boat, wave, and surroundings could result in the surfer losing control and falling from the surfboard. Injury could result.

Phone Holder

Axis dashes are equipped with a phone holder on the inboard side of the dash. The standard phone holder is a billet fence with EVA padding.

The optional Sport Dash phone holder assists in keeping the phone firmly situated in the dash with uniquely designed bellows that give way when you push your phone down into the slot. When using the Sport Dash phone holder with cases thicker than 3/4-inch, be careful not to push down too hard as the thickness of the case could damage the bellows and/or the phone itself.



Wireless Charging Phone Holder

CAUTION

Remove all objects from the charging pad before charging your mobile device. Objects, such as coins, keys, rings, paper clips, etc., between the phone or device and the charging pad will become very hot. On the rare occasion that the charging system does not detect an object and the object gets wedged between the device and the charger, remove the device and allow the object to cool to prevent burns, before removing it from the charging pad. Please note that it is best practice to not put metallic objects on top of the wireless charger.

Axis boats are optionally equipped with a wireless charger at the dash. While the charger interfaces with many personal wireless devices, particularly mobile phones, it will not recharge every device.

Check the operating instructions or owner's manual for the individual device to determine whether the device is rechargeable via this type of pad. Axis makes no claims that the pad will operate with your device.

ELECTRICAL SYSTEMS

Blower System

Always operate the blower for at least four (4) minutes prior to starting the engine, and when running at a low speed or at idle. This must be done with the engine compartment open. Failure to perform this necessary function could result in an explosion of the accumulated fumes within the compartment, leading to serious injury or death. This information is provided in detail throughout this owner's manuals.



Note: When the dash and 7" Display are powered ON, the blower will start automatically. The display will turn the blower OFF after four (4) minutes. However, operators should always verify that the blower is ON and operating, rather than relying on the automatic ON.

The blower system vents carbon monoxide, a naturally occurring by-product of the engine and drive train operation, through the exhaust manifold, muffler, exhaust lines and flap (where equipped) that combine to remove dangerous carbon monoxide and other naturally occurring toxic by-products from the engine and drive train operation. The emissions primarily are eliminated through the exhaust port located beneath the swim platform. Although much of the exhaust is disbursed into and through the water, fumes still reach the swim platform and transom area of the boat including the sun pads. Therefore, no one should ever be on the swim platform, transom, or sun pads when the engine is operation. See the *Safety* section of this manual for more detail.

Never operate the boat if you or anyone on boards suspects that the exhaust or fuel system is not performing as designed.

Read the *Blower System* information in the *How It Works* section and the entire *Safety* section in this manual. Vital information is included in those sections regarding proper operation and safety considerations for the blower system in addition to the operational information provided here.

Bilge Pumps

The bilge pumps can be manually controlled using the 7" Display. The boat is also equipped with an automatic control that is explained in the *How It Works* section of this owner's manual.

The safe operation of the boat is dependent upon a properly functioning bilge system. The bilge is a void between the deck and hull in which unintended water accumulates as it is drained from other areas of the boat. (It does not include the water in the ballast system, which is contained in tanks, and possibly an optional bag.)

The bilge should be routinely checked and drained, as necessary. The automatic function will often keep the system free of excess water. Too much water in the system can affect the boat's handling under operation, and can potentially swamp a boat, causing damage to other components in the bilge compartment, or even sinking of the boat.

With the exception of boats configured for certain international locales, all boats are equipped with two (2) bilge pumps. One pump is in the center of the boat, directly below the center pie-plate access. The second pump is located at the transom of the boat, aft of the engine on the port side.

Bilge pumps can be turned ON manually or they function automatically. The bilge pumps are also equipped with a sensor to automatically trigger instant-on if water is sensed around the pump. This functions continuously. The automatic mode will always be activated, even if the battery isolator switch is turned to the OFF position. Therefore, be certain the pump is working properly and there is no kink in the output hose before storing the boat for extended periods of time since the bilge pump will continue to run if it senses water. Otherwise, this could cause a battery to drain and could damage the pump over time.

There will always likely be a small amount of water in the bilge as the pump cannot eliminate 100% of the water. A minor amount of water is acceptable. However, operators should monitor bilge water levels through the center pie-hole access plate. In all models, this hole is in the center of the floor near the driver's helm. (It may be under carpet or a mat.) It should remain secure during operation and opened only when the boat is stationary and the engine not running. Be certain to close the access plate before operating the boat again. Since the threads on the plate can sometimes be misdirected when securing, double-check. Individuals on-board could trip and injure themselves if the access plate is not secured properly.

All boats are equipped with two (2) drain plugs, a 1/2" drain plug on the transom and a T-handle drain plug in the center of the boat. The 1/2" drain plug can be accessed outside the boat, directly under the swim platform on the center back of the transom. On Axis boats, the T-handle can be accessed inside the boat through the center pie-hole access plate. Be certain to read the above information regarding **SECURELY** installing drain plugs prior to all outings.

Never operate the boat if you or anyone on board suspects that the bilge system is not performing as



designed.

Read the *Bilge System* information in the *How It Works* section and the entire *Safety* section of this manual. Vital information is included in those sections regarding proper operation and safety considerations for the blower system in addition to the operational information provided here.

Ballast System

The 7" Display or, if equipped, the Sport Dash keypad can operate the ballast system. The button marked "BOW" is pressed once to fill the bow ballast tank. The left side LED on that button will light to show that the tank is filling. A second press of the button will drain the tank. The right side LED on that button will light to show that the tank is draining. A third press turns the pump OFF.

The *Center*, *Port* and *Starboard* buttons (which indicate the tank location) operate in the same manner as the *Bow* button.

Be sure to empty the ballast tanks prior to loading the boat onto the trailer and removing the boat from the water. Tanks **MUST** be empty prior to towing the boat as the additional weight can cause damage to the trailer and/or the vehicle, and imbalance on the trailer that could affect safety or overload the trailer and cause damage that is not covered under warranty.



WARNING

Water in the ballast tanks should always be pumped out prior to removing the boat from the water. Never tow the boat on a trailer with water in the ballast tanks; residual water can cause an imbalance that alters the amount of weight on the trailer tongue. Without the proper weight percentage forward, the tongue can become unstable and cause loss of control of the trailer and tow vehicle. Additionally, attempting to tow your boat without the ballast tanks and/or bags emptied can overload the trailer and cause damage that is not covered under warranty.

When emptying the ballast tanks, watch the outlets on both sides of the boat and aft, depending on the model and number of outlets. (If you are uncertain, check with your authorized Axis dealer for assistance in determining the bilge outlets from the ballast outlets.) Ballast pumps will continue working until the overrun timer expires. Ensure that the tank is completely empty or that the outlets show only a minute amount of water is coming out.

If the boat is equipped with optional Plug 'n Play, Axis recommends rechecking that the rear tanks are empty five minute after starting the drain process. This verifies that no extra water was left from Plug 'n Play and leaked into the hard tank.

Be sure to review the *Ballast System* information in the *How It Works* section of this manual for more information.

NOTICE

Ballast pumps must be turned OFF after emptying the tanks. When only a drizzle of water is coming from the outlets, manually turn OFF the ballast pumps, via the button. There is an overrun timer that will turn the pumps off to ensure that they do not run when dry. Allowing the ballast pumps to continue operating when there is no water to be pumped will result in the internal components being permanently damaged, which is not covered under warranty.

Alarms

NOTE: Audible alarms are functional through the instrument panel, **EXCEPT** the Surf Gate transfer alarm, which sounds through the stereo system. Therefore, if the stereo is turned OFF or the boat has *Stereo Option Null* or *Sound Pack 1*, persons on board will not be able to hear an alarm. The alarm system is equipped on all boats regardless of optional equipment, and alarm information for the engine and vessel will be available through the 7" Display.

The boat is equipped with several alarm systems. In general, an alarm sound is an indication that a potentially significant issue exists. The low-voltage alarm functions when the battery system charge has fallen to a level that could result in the boat becoming unable to continue the outing. The low-voltage alarm will be accompanied by the indication on the dash. Follow directions as they appear.

Sensors will also alert the boat operator when the oil pressure, engine and/or transmission temperatures are outside acceptable parameters. All alarms should be taken seriously, and boaters should return to shore as soon as possible.



Seek assistance from your authorized Axis dealer to determine the cause and solution to any problems that have been indicated.

Audible Alarm Tones

There are three tones that the instrument panel will use to identify alarms:

No Tone

There is no audible sound for these alarms.

Single Tone

A 500ms tone is played for these alarms.

Engine Tone

A five-second tone that is followed by a 100ms tone every 60 seconds.

Vessel Alarms

Low Battery Voltage Alarm

Audible: Single tone.

Visible: A banner on the display states “Low Battery Voltage.” Once acknowledged it does not reoccur until returning into the threshold. The battery voltage readout on the display will turn amber until the alarm is no longer active. The system warning icon will be visible when a trigger is active. If the voltage drops below 10.5V for 10 seconds, the battery voltage readout on the display will turn **Red**. When the voltage is above 10.7V for 10 seconds, the battery voltage readout on the display will turn back to **Amber**.

Trigger: Set after dash voltage is below 11.0V for 10 seconds. Alarm will reset when battery voltage is above 11.2V for 10 seconds.

Low Fuel Alarm

Audible: Single tone.

Visible: A banner on the display states, “Low Fuel.” Once acknowledged, it does not reoccur until the threshold is reentered. The Fuel Level readout on the display will turn amber until the alarm is no longer active. The *System Warning* icon will be visible when the trigger is active.

Trigger: Set when the fuel level is below 15% for 60 seconds.

Shallow Alarm

Audible: Single tone. Once acknowledged, it does not reoccur until returning to the threshold.

Visible: A banner on the display states, “Shallow Water Alarm.” The System Warning icon will be visible when the trigger is active. The depth readout on the display will turn **Amber** until the alarm is no longer active.

Trigger: Set when the depth transducer is reporting a depth equal to or lower than what is set for the *Shallow Water Set Point* for two (2) seconds.

Reset: Once the depth transducer reports the depth greater than the *Shallow Water Set Point* for five (5) seconds.

Auto Bilge Alarm

Audible: No tone.

Visible: The *System Warning* icon will be visible when the trigger is active. The *Control* page will also show the bilge animation.

Trigger: Set when either the fore or aft bilge is detected as ON when neither bilge pump was activated through the 7” Display *Control* screen.

Wedge Drag Alarm

Audible: No tone.

Visible: The *System Warning* icon will be visible when the trigger is active.

Trigger: Set when the boat is traveling above 10mph and *Wedge* is between *Stow* and *Wedge 6*.

High Speed Wedge Down Alarm

Audible: No tone.

Visible: The *System Warning* icon will be visible when the trigger is active.

Trigger: Set when the *Power Wedge* is in *Lift*, *Wedge 1*, *Wedge 2*, *Wedge 3*, *Wedge 4*, *Wedge 5*, or *Wedge 6*, or if the *Manual Wedge* is deployed and the vessel is moving faster than 26.0 mph.



Surf Gate High Speed Alarm

Audible: No tone.

Visible: The *System Warning* icon will be visible when the trigger is active.

Trigger: Set when a *Surf Gate Retracted Limit Switch* input is low, and the vessel is moving faster than 15.0 mph.

Surf Gate Left Alarm

Audible: No tone.

Visible: The *System Warning* icon will be visible when the trigger is active.

Trigger: Set when:

- the Surf Gate has been retracted and the *Limit Switch* input does not go high
- the Surf Gate has been commanded to *Extend*, but the *Limit Switch* input is high
- the Surf Gate is retracted and loses the *Limit Switch* input for two (2) seconds

Surf Gate Right Alarm

Audible: No tone.

Visible: The *System Warning* icon will be visible when the trigger is active.

Trigger: Set when:

- the Surf Gate has been retracted and the *Limit Switch* input does not go high
- the Surf Gate has been commanded to *Extend*, but the *Limit Switch* input is high
- the Surf Gate is retracted and loses the *Limit Switch* input for two (2) seconds

Power Module Overcurrent Fault

Audible: Single tone.

Visible: A banner on the display states, "Power Module Fault." The *System Warning* icon will be visible when either trigger is active.

Trigger: Set when:

- there is an overcurrent fault that occurs on any of the outputs on *Power Module 1*.
- there is an overcurrent fault that occurs on any of the outputs on *Power Module 2*.

Check Engine Alarm

Audible: Engine tone.

Visible: A banner on the display states, "Check Engine." The *Check Engine* light will be visible until the fault is no longer active.

Trigger: Set when the Engine Control Module sends a SPN/FMI and triggers the *Check Engine* light.



engines and powertrains



AXIS MONSOON ENGINES, TRANSMISSIONS, AND V-DRIVES

CAUTION

Generally, Axis boats are equipped with the Monsoon drivetrain, built in-house. Some models or individual boats, however, may be equipped with drivetrains built by manufacturing partners. In those instances, the boat will ship with a separate engine owner's manual. All care and maintenance requirements should follow that manual rather than the engine documentation set forth in this manual. Failure to do so may void the warranty.

Axis offers outstanding powertrain options. Although engine experiences vary by type and size, all engines are based on the General Motors platform.

Boats equipped with Monsoon engines also require proper attention to adhere to warranty policy. Note that these instructions should be followed even after the warranty period has expired. The instructions developed for the engines and powertrains in Axis boats function as the guidelines to a long-term, positive boating experience.

CAUTION

Failure to follow engine operation, care and maintenance instructions as provided in this manual can result in damage to the engine and transmission that is not covered under warranty. Under some circumstances, this could result in the boat becoming inoperable, stranding boaters and/or placing those on-board in situations that could result in potentially dangerous situations.

CAUTION

Owners/operators must follow the instructions and must pay particular attention to the *Saltwater Care and Maintenance* instructions, which appear in the *Care and Maintenance* section of this manual. Using the flush kit, where equipped, is essential to ensuring a long life for the Monsoon engine. Failure to follow those instructions can void the warranty, as well as adversely affect the operation of the engine and powertrain.

Axis Boats has teamed with General Motors to produce the ideal engine and transmission for the expected usage



of the boat. Because Axis boats were created to further enjoyment of watersports, the power curve and maximum performance of the package were designed to enhance every aspect of the experience.

THE FOLLOWING INFORMATION IS PROVIDED FOR THE MONSOON ENGINES. UNLESS OTHERWISE DIRECTED, THE INSTRUCTIONS ARE APPLICABLE TO ALL AXIS-BUILT ENGINES AND POWERTRAINS.

Safety

Significant safety information appears in the opening chapter of this manual. It is critical to read the entire manual, with particular attention to the safety information. All boat owners and boat operators must adhere to the safety requirements as described. It is also the responsibility of these individuals to be aware of U.S. Coast Guard regulations when boating in U.S. waterways, or the governing body(ies) of any waterway system in which the boat is operated.

Failure to read and follow this information will NOT exempt or excuse boaters from the requirements.

This information also materially impacts the boat's warranty coverage. It is the owner's and/or operator's responsibility to perform all inspections and required maintenance prior to the operation of the boat, without exception.

In addition to the opening chapter, the following drive train-specific, safety-related material is provided. Please review and follow these guidelines to ensure the safety of yourself, boat operators, passengers and others who may be in the area.

Prior to Operation

Follow the instructions as described in *Before Each Use* in the *Care and Maintenance* section of this manual.



To prevent a possible explosion, always operate the blower until it automatically shuts off (at least four [4] minutes), prior to starting the engine. Always operate the blower when the engine is idling or at a low running speed. Improper ventilation can lead to accumulation of gasoline or exhaust fumes in the compartment. This can lead to a fire or explosion, either of which can result in serious injury or death!



Never start the engine in the presence of fumes or signs of gasoline leakage. Always avoid smoking or open flame near the engine compartment.

Other Safety Double Checks

Throughout this section of the Owner's Manual, additional safety issues are reiterated. Always follow these instructions. Repeating checks and inspections is far superior to ever skipping any of these requirements and suggestions.

GENERAL INFORMATION

Serial Numbers

Each engine is assigned a unique serial number that is different from the Hull Identification Number (HIN) found on the transom of the boat. The engine serial number can be found in three locations on the engine: the bank one engine lifting eye, the top of the transmission, and the front of the oil pan.

It is extremely rare that an engine requires replacement in a boat; however, if this occurs, the replacement engine's serial number must be reported to the Axis warranty department, even if the warranty statement effective dates have expired. In the event of a safety matter or recall,



serial numbers often alert the factory to which boats may be affected and allow the company to contact consumers. Engine serial numbers that do not match factory records may lead to questions of legality also.

Engine Specifications

Engine Descriptor	M5Di	M6Di	LT4
Type/Aspiration	4 Cycle – Naturally Aspirated	4 Cycle – Naturally Aspirated	4 Cycle – Super Charged
Engine Configuration	90-degree V8	90-degree V8	90-degree V8
Displacement (cc)	5,300cc (327 CID)	6,200cc (383 CID)	6,162cc (376 CID)
Borespacing (mm)	111.76	111.76	111.76
Bore x Stroke (mm)	96.01 X 92	103.25 X 92	103.25 X 92
Compression Ratio	11:1	11:1	10:1
Fuel Compatibility	Gasoline	Gasoline	Gasoline (Premium Only)
Engine Rotation (Front)	CW	CW	CW
Block / Head Material	Cast Aluminum	Cast Aluminum	Cast Aluminum
Block Structure	Deep Skirt	Deep Skirt	Deep Skirt
Main Bearing Caps	6 Bolt	6 Bolt	6 Bolt
Valvetrain Configuration	OHV-CIB	OHV-CIB	OHV-CIB
Valves per Cylinder	2V	2V	2V
Valve Lifter / Lash Adjuster	Roller Hydraulic	Roller Hydraulic	Roller Hydraulic
CAM Drive	3/8" Roller Chain	3/8" Roller Chain	3/8" Roller Chain
Firing Order	1-8-7-2-6-5-4-3	1-8-7-2-6-5-4-3	1-8-7-2-6-5-4-3

Engine Coolant

All Monsoon engines feature a hybrid of raw water cooling and closed cooling. **The closed cooling must have a 50/50 mix of marine-grade, propylene glycol coolant (such as Peak Sierra brand) and clean, distilled water. DO NOT USE ANY ETHYLENE-BASED PRODUCTS.** From an empty tank to the proper amount of coolant/water mix will require approximately four (4) gallons.

Directions for maintaining proper levels are provided in the *Care and Maintenance* section of this manual. Maintaining proper levels is required to keep the warranty in effect, and the instructions should continue to be followed for the life of the boat/engine. Boat owners should also carefully follow the raw water cleaning information provided in the *Care and Maintenance* section of this manual, especially when operating in saltwater or brackish water conditions. Failure to do so will void the warranty. Also see the *Saltwater Care and Maintenance* information provided in the *Care and Maintenance* section of this manual.



Engine Oil

In M-Series engines, use only 5W30 full synthetic dexos™ Gen2 Engine Oil. Axis strongly encourages the use of Malibu-branded oil (available only from your authorized Axis dealer). **In LT4 engines, use ONLY 0W40 full**





synthetic dexos™ Gen2 Engine Oil. If Malibu-branded oil is not available, use ONLY Mobil 1, per General Motors. Use of other oil may void the warranty.

The engine requires approximately nine (9) quarts to fill from empty. (Never over-fill the engine oil, nor run the engine without sufficient oil as indicated on the oil dipstick.) The use of any other oil or fluid may void the warranty. Instructions for proper levels, maintenance and oil changes are provided in the *Care and Maintenance* section of this manual.

Transmission Fluid

Your boat arrives from the factory with DEX/MERC ATF in M-Series and LT4 engines. You must continue to use this transmission fluid. Use of any other transmission fluid will void the warranty.

Approximately 2.5 quarts will be required to fill from empty. The use of any other fluid may void the warranty. Instructions for proper levels, maintenance and oil changes are provided in the *Care and Maintenance* section of this manual.



Hydraulic Steering Fluid

The steering in Axis boats may feature an optional hydraulic system that can be maintained or repaired only with specialized tools. Because of the potential for physical harm when working on this system, it cannot be checked, changed or repaired by consumers. Only an authorized Axis dealer has access to the tools and system. While we recognize that some consumers may be located many miles from the nearest authorized Axis dealership, seeking out and utilizing an authorized Axis dealer is a requirement. We apologize for any inconvenience.

Fuel Filter

Monsoon engines are equipped with a Smart Fuel Filter that separates water from the boat's fuel and alerts the operator—via the dash—when an unacceptable level of water is detected in the fuel system. Do not ignore such alerts from the Smart Fuel Filter, as continued operation of the boat with water in the fuel system can lead to engine damage and/or failure.

As with the steering system, only authorized Axis dealers have the specialized tools needed to work on any portion of the fuel system. Again, this is a safety matter. Never attempt to work on the fuel system.



Boat owners or any person who is not an authorized Axis dealer technician should never attempt to work on the steering or fuel systems within the boat. These systems require specialized tools not available to the public. Any alteration to or attempt to alter these systems will void the warranty. It is also highly likely that serious injury or death could occur to unauthorized persons attempting to access these systems.

Maintenance Schedule

The maintenance schedule for Monsoon Engines is provided in the *Care and Maintenance* section of this manual. **Do not attempt to operate the boat until after you have read this entire Owner's Manual.**

CALIFORNIA EMISSIONS INFORMATION

Malibu Boats, LLC., and its subsidiary Axis Boats, have long worked with the state of California to ensure that emissions from our products remain in compliance with California's legal requirements. This means attention to aspects of the warranty statement and process, with particular attention to providing this information in clear, written style.

If you have any questions regarding this matter, please feel free to contact your authorized Axis dealer.



CALIFORNIA EVAPORATIVE EMISSIONS CONTROL SYSTEM WARRANTY STATEMENT¹

YOUR WARRANTY RIGHTS AND OBLIGATIONS

The California Air Resources Board and Axis Boats are pleased to explain the evaporative emission control system's warranty on your 2024² spark-ignition marine watercraft. In California, new spark-ignition marine watercraft (SIMW) must be designed, built, and equipped to meet the State's stringent anti-smog standards. Axis Boats must warrant the evaporative emission control system on your spark-ignition marine watercraft for the period listed below, provided there has been no abuse, neglect or improper maintenance of your SIMW.

Your evaporative emissions control system may include parts such as: canisters, carburetors, clamps, connectors, filters, fuel caps, fuel lines, fuel tanks, valves, vapor hoses, and other associated evaporative emissions control system components.

MANUFACTURER'S WARRANTY COVERAGE

This evaporative emission control system is warranted for five years³. If any evaporative emission-related part on your SIMW is defective, the part will be repaired or replaced by Axis.

OWNER'S WARRANTY RESPONSIBILITIES

As the spark-ignition marine watercraft owner, you are responsible for performance of the required maintenance listed in this manual. Axis recommends that you retain all receipts covering maintenance on your spark-ignition marine watercraft, but Axis cannot deny warranty solely for the lack of receipts.

As the spark-ignition marine watercraft owner, you should, however, be aware that Axis may deny you warranty coverage if your spark-ignition marine watercraft or a part has failed due to abuse, neglect, or improper maintenance or unapproved modifications.

You are responsible for presenting your spark-ignition marine watercraft to an Axis distribution center or service center as soon as the problem exists. The warranty repairs should be completed in a reasonable amount of time, not to exceed thirty (30) days. If you have a question regarding your warranty coverage, you should contact Axis Boats' warranty department at 1-865-458-7110.

* Note:

- (1) As they relate to the evaporative emissions control system. This statement applies only to California.
- (2) Emission warranty model year (2024) will be updated each model year and no other changes will be made.
- (3) Axis voluntarily extended the warranty period from two years as required by the California Air Resources Board to five years.

The California evaporative emissions control system warranty covers the following list of components:

- Belts
- Carbon canister
- Catalytic converters
- Clamps*
- Coolant temperature sensor
- Control linkages*
- Control valves*
- Electronic controls*
- Electronic control module
- Exhaust manifolds
- Exhaust risers
- Exhaust valves
- Flame arrestor
- Fuel cap
- Fuel injectors
- Fuel pressure regulator
- Fuel line
- Fuel line fittings
- Fuel tank
- Idle Air Control (IAC) valve
- Idlers
- Ignition coil and/or control module
- Ignition wires
- Intake manifold
- Intake valves
- Liquid/vapor separator
- Manifold Absolute Pressure (MAP) sensor
- Oil filler cap
- Oil pump and internal parts
- Oxygen sensors
- Pulleys
- Purge valves
- Spark plugs
- Throttle body-port fuel injection models
- Throttle body assembly-throttle body fuel injection models
- Throttle position sensor
- Vacuum control diaphragms*
- Vapor hoses
- All other parts not listed that may affect the evaporative emissions control system, including hoses fittings, etc.



General Emissions Information

After January 1, 2009, boats sold or registered in California have a Star label on the port side of the hull adjacent to the vessel registration, as shown.

Exhaust emissions should be routinely monitored and verified throughout the life of the boat. The boat owner has responsibility to ensure that the engine is never modified in any fashion that alters the emissions occurring during operation. The engines have been constructed to meet specifications as established by governing bodies with authority in this matter. Routine maintenance performed by authorized Axis dealers should satisfy these requirements, but having maintenance completed by an authorized Axis dealer does not absolve the boat owner from responsibility that emissions requirements are satisfied in the area in which the boat is owned and/or operated.

Each engine has an Emissions Control Information (ECI) label affixed. A sample label is illustrated in this section. Information appearing on the label must never be altered. If the original, factory-affixed label is damaged or comes off the engine block, contact an authorized Axis dealer immediately for a replacement. Axis does not endorse the replacement of these labels by any unauthorized person.

Engine emissions labels with the designation “CE” in the lower right-hand corner have been constructed within the parameters of the Declaration of Conformity requirements. This means that the engine conforms to the appropriate European Community Directive.

Star Label

A Star label is also affixed to the heat exchanger of each certified engine. All Monsoon engines, at minimum, have a Four Star—Super Ultra Low Emission rating. This means that the engine has ninety percent (90%) lower emissions than a One Star—Low Emission engine. It further means that the engine meets the California Air Resources Board’s stern drive/inboard marine engine Tier 3 exhaust engine standard.

Engines will also have an explanatory “Star” label attached, as shown. The applicable Star level will be marked, and an explanation of the label designation appears on the reverse side. The explanations are:



One Star—Low Emission. The one-star label identifies engines that meet the Air Resources Board’s Personal Watercraft and Outboard marine engine 2001 exhaust emission standards. Engines meeting these standards have 75% lower emissions than conventional carbureted two-stroke engines. These engines are equivalent to the U.S. EPA’s 2008 standards for marine engines.



Two Star—Very Low Emission. The two-star label identifies engines that meet the Air Resources Board’s Personal Watercraft and Outboard marine engine 2004 exhaust emission standards. Engines meeting these standards have 20% lower emissions than One Star—Low Emissions engines.



Three Star—Ultra Low Emission. The three-star label identifies engines that meet the Air Resources Board’s Personal Watercraft and Outboard marine engine 2006 exhaust emission standards or the Sterndrive and Inboard marine engine 2003-2008 exhaust emission standards. Engines meeting these standards have 65% lower emissions than One Star—Low Emission engines.



Four Star—Super Ultra Low Emission. The four-star label identifies engines that meet the Air Resources Board’s Sterndrive and Inboard marine engine 2009 exhaust emission standards. Personal Watercraft and Outboard marine engines may also comply with these standards. Engines meeting these standards have 90% lower emissions than One Star—Low Emission engines.



Five Star—Level Five Extremely Clean. The five-star label identifies engines that meet the Air Resources Board’s Voluntary Standards for spark-ignition marine engines. Engines meeting these standards have 50% lower emissions than Four Star—Super Ultra Low Emission engines.

Additional Information, Including Warranty

Monsoon engines are prepared for the consumer in accordance with the applicable regulations as established by the California Air Resources Board as authorized by Chapters 1 and 2, Part 5, Division 26 of the California Health and Safety Code, and the United States Environmental Protection Agency, as described by 40 CFR 1045.



Defects resulting from any source other than that described in the Axis Limited Warranty Statement are not covered. Parts required for routine maintenance during the warranty period are also not covered. Examples would be, but are not limited to, spark plugs or filters or fluids. However, such components may be covered if failure occurred during the first 10-hour break-in period. The warranty will not be extended beyond its original expiration date for any reason, and the use of unapproved replacement parts may void any remaining warranty, per the Axis Limited Warranty Statement. Replacement parts do not extend the warranty beyond its original period. Parts replaced under the limited warranty become the property of Monsoon Engines.

Warranty coverage may be denied in instances where the emissions component(s) had been altered or damaged by neglect, or there is evidence of failure to perform maintenance as required by information provided within this manual. If other, non-emission parts have been damaged as a result of failure to properly maintain or repair an emissions-related component, the non-emission component(s) may also not be covered under the Axis Limited Warranty Statement. See the *Care and Maintenance* section of this manual for information regarding appropriate maintenance.

MONSOON ENGINE SUPPORT SYSTEMS

Axis Fuel System

All Axis models are equipped with the most up-to-date fueling system available in the marine industry. The boats feature pump-in-tank (PIT) fuel systems, which means the fuel pump is located securely inside the fuel tank rather than at the engine. There are many benefits to the PIT system, most significantly in the prevention of vapor lock and improved filtration of contaminants. A camshaft-driven fuel pump is also located internally in the engine.

To maximize the benefit of this type of fuel pump, the entire system is under high pressure. That means that access to the pump and the pump-in-tank fuel filter is only through fuel lines with a significant pounds-per-square-inch (PSI) pressure to ensure proper operation. As such, no one can or should ever attempt to access any portion of the fuel system without proper training and proper equipment.

The fuel lines are covered in orange “fire-sleeve” protective covering so that they are easily identifiable, and consumers should always avoid these lines, unless it is noted that one is squeezed or pinched. If it is possible to alleviate this situation safely, then do so. The preferable method, however, is to have an authorized Axis dealer’s trained service technician do so and verify that no damage has been done to the line or other equipment.

The Axis fuel system from tank to plumbing to engine meets or exceeds U.S. Coast Guard requirements (Sec. 183.540 Recreational Boating). Because of the potential for a dangerous, even catastrophic event if any part of the system fails, Axis strongly encourages all owners/operators to always be aware of proper operation. Follow operational directives, maintenance requirements and remain alert for visual signs or odors that indicate the presence of fuel outside the contained fuel system. Never replace any part of the fuel system except with approved parts, and Axis recommends always using your authorized Axis dealer for checks, service and repair of the fuel system.

Normally, if there is any issue arising from damage or leakage in the fuel system a strong odor of gasoline will be present and signifies that the engine should not be started due to the danger of explosion from fumes. Even in the absence of a gasoline odor, owners and operators should always visually check the fuel system prior to operation, as directed in the *Care and Maintenance* section of this manual.



DANGER

The fuel system, including the fuel lines, pump-in-tank filter and pump, should never be serviced by any person other than an authorized Axis dealer’s trained service technician. Special tools and training are required to safely service the fuel system on all models.



 **DANGER**

The flammability of gasoline and its explosive properties must always be respected. At the first odor of gasoline, the engine should be shut off and remain off until the source of the odor has been identified, and the issue has been rectified. Never start the engine if the odor of gasoline is present or if gasoline is seen anywhere in the boat other than the fuel system!

 **DANGER**

Never smoke or operate any spark-producing object within a fifty-foot (50') range of the boat when fueling. Fumes from gasoline are more likely to produce an explosion and/or fire than the actual fuel. Be sure that the fueling area is well-ventilated.

 **DANGER**

If fuel is spilled, always clean up with dry rags and dispose of properly on-shore.

 **DANGER**

Replacement parts in any portion of the fuel system must be with Axis-authorized parts only! Use of unapproved parts could result in a failure that creates a potentially explosive situation or the potential for on-board fire.

 **WARNING**

Avoid inhaling or ingesting gasoline and/or fumes. If gasoline gets on skin, immediately flush with copious amounts of fresh water on-shore; if gasoline gets on clothing, immediately change clothing and do not store gasoline-infused cloth on board the boat.

Axis recommends returning to shore and refueling whenever the fuel gauge indicates that the fuel load has fallen below one-quarter (1/4) of a tank full. **It has also been determined that continuous operation with ballast significantly loaded either port or starboard (rather than evenly distributed) can result in damage to the fuel pump as it attempts to compensate.** Even with the best of care, some water may get into the fuel tank or separate from the fuel that is pumped into it. If there is water present, it will settle on the bottom of the tank. If the pump begins to reach any water, it may cause malfunctioning in the engine.

 **CAUTION**

Do not over-fill the fuel tank. Doing so can cause spillage, which is an environmental hazard. Fuel tanks also expand and contract slightly to adjust to ambient air temperature. Over-filling can reduce the ability of the tank to respond, which can cause damage to the fuel system and/or boat, which is not covered under warranty.

 **NOTICE**

Review the Care and Maintenance section of this manual for important information regarding the proper fuel to use, how to maintain the fuel if the boat will not be used for a period of time, and other important information regarding the safe use of gasoline in the boat. Always include a pre- and post-outing inspection of the fuel system.

 **NOTICE**

Use of incorrect fuel can result in damage to the engine that is not covered by Axis. Failure to follow maintenance requirements may also void the warranties.

When pumping fuel, do not leave the nozzle unattended in the fuel fill. Although the fuel system has been manufactured to avoid spit-back of fuel, and most gasoline dispensers will shut off if removed from fuel fill, it is always a wise consideration to provide full attention to the process.

Fuel Information

The minimum octane requirement for a M-Series engine is 87 (R+M)/2 or 92 Euro RON. Minimum octane requirement for the LT4 is 91 (R+M)/2 or 95 Euro RON. When possible, use 93 octane if available as this will ensure the best performance possible from the engine. (Boaters outside the U.S. and Canada should confer with their authorized Axis dealer to determine the correct fuel grading, as it is often graded differently from how it is designated in the U.S. and Canada, which is described herein.)



Lower-octane fuel may cause deposits on the fuel injectors and intake valves, among engine components. Continued over a period of time, the lower-octane fuel could damage the engine, and such damage is not covered under warranty.

One of the first signs of improper fueling is a knocking noise resulting from spark plug misfire. Knock misfire will damage the engine over time. Because the engine is equipped with a knock sensor, operators may be alerted when the sensor triggers a warning through the video screen. Do not ignore such warning!

The engines are engineered to run smoothly. **If there are any symptoms of misfire, hesitation, poor idling or if the engine becomes hard to start, such indications should not be ignored.** If the gasoline has been in the boat's tank for an extended period (in excess of two weeks), particularly without a stabilizer, the issue sometimes may be addressed by properly replacing the fuel with new gasoline.



Always dispose of unused fuel properly on-shore. Check with local authorities to determine the proper manner in which fuel can be off-loaded from a boat. **NEVER** dump fuel into the water. It is illegal to do so as well as environmentally damaging. Allowing fumes to be vented can also cause a situation in which a spark or open flame could cause a fire, which is extremely dangerous and could result in serious injury or death.

Never add diesel fuel to the fuel tank! Diesel fuel and regular gasoline do not mix. Diesel fuel will cause permanent damage to the engine, and such damage is not covered under warranty. If diesel fuel is accidentally pumped into the Axis system, all contents of the fuel tank must be properly disposed of on-shore, and the engine should not be started until the system is thoroughly cleared and the correct fuel pumped into the fuel tank.

When Fueling

When pumping fuel, do not leave the nozzle unattended in the fuel fill. Although the fuel system has been manufactured to avoid spit-back of fuel, and most gasoline dispensers will shut off if removed from fuel fill, it is always a wise consideration to provide full attention to the process.

Axis strongly recommends using 93 octane TOP TIER detergent gasoline. The additives and detergents in these fuels can reduce the amount of build-up in engines that adversely affects performance and shortens the life of an engine. Retailers selling TOP TIER gasoline can be found at www.toptier.com.

Never use E-85 or other E- fuels. This type of fuel does not contain sufficient additives to protect the engine nor perform to expected standards.

Never use leaded fuel. Monsoon engines are designed and constructed to run properly **ONLY** on unleaded gasoline. If finding unleaded gasoline is an issue for a boat owner, check with your authorized Axis dealer to locate unleaded gasoline.

Never use gasoline containing higher than ten percent (10%) ethanol. Use of gasoline containing 15 percent (15%) ethanol is prohibited in recreational boats and will void the warranty. Some fuel contains MBTE (methyl butyl tertiary ether) as a blend to enhance octane. Blended fuel is permissible as long as it is blended and does not exceed the percentage allowed.

Never use gasoline that contains any methanol. This type of fuel can cause corrosion to some of the engine parts, and such damage would not be covered under warranty.



Always verify that the fuel filler access is closed when the engine is running. Failure to do so may allow water to enter into the fuel system. Such intrusion could result in damage to the engine and is not covered under warranty.

When fueling the boat outside the United States or Canada, verify the chemical components of the available gasoline. You must use only approved fuel. Work with your authorized Axis dealer to locate appropriate gasoline for use.



When the Boat Is Not in Operation (Fuel)

When maintained as directed in the *Care and Maintenance* section of this manual, boats can reasonably be expected to be ready for operation when they are not used for a period of two (2) weeks or less. Longer than two (2) weeks requires particular attention to fueling, among other operations. If the engine does not start and run smoothly, it is likely that there are issues involving gasoline.

When allowed to sit for extended periods of time, fuel components can begin to separate or deteriorate. Any water that has intruded into the fueling system will separate, and because it is heavier than gasoline, will settle to the bottom of the tank. The current fuel system, which includes a spring-loaded gas cap, should not allow significant amounts of water into the system, but operators should always verify that the fuel filler cap is closed anytime the boat engine is on.



Any time the boat is not going to be used for a period in excess of two (2) weeks, Axis recommends adding STA-BIL® fuel stabilizer to the fuel tank. Although there are other anti-degrading stabilizers on the market, Axis has found that STA-BIL®, when used properly, protects engines and fueling systems from the harmful effects of storage in most instances. Note, however, that even stabilized fuel can cause an engine to idle poorly and run less effectively until the older fuel has been used up. This kind of damage is not covered under warranty.

Even with the use of STA-BIL®, long-term storage with fuel in the tank and fueling system can result in degradation of the fuel. This can cause the engine to perform poorly until the fuel is used, but in some instances can cause permanent damage to the fuel system and/or engine. Such damage is not covered under warranty.

If the boat will be stored for a significant period of time, such as an entire off-season, Axis recommends filling the fuel tank full and adding STA-BIL®. Because STA-BIL® will eventually degrade, boat owners should follow the instructions provided by STA-BIL® regarding storage period, temperatures, amount of mix, and any other information provided by the manufacturer of STA-BIL®.

NO ADDITIVE OTHER THAN STA-BIL® IS APPROVED; USE OF ANY OTHER ADDITIVE MAY VOID THE WARRANTY.

Electrical System

It is important that operators/owners review the *Electrical Components* information in the *Dashes and Video Screens* section of this manual prior to using the boat. Recommendations and requirements explained in that section can prevent unexpected issues from arising that will cause abbreviated outings or premature degrading of components.

Alarms

Note: Audible alarms are functional through the instrument panel, **EXCEPT** the Surf Gate transfer alarm, which sounds through the stereo system. Therefore, if the stereo is turned OFF persons on-board will not be able to hear an alarm.

The alarm system is equipped on all boats regardless of optional equipment, and alarm information, including the Surf Gate transfer alarm information, will be available through the video screen.

The boat is equipped with several alarm systems. In general, an alarm sound is an indication that a potentially serious issue exists. The low-voltage alarm functions when the battery system charge has fallen to a level that could result in the boat becoming unable to continue the outing. The low-voltage alarm will be accompanied by an indication on the dash. Follow directions as they appear.

Sensors will also alert the boat operator when the oil pressure, engine and/or transmission temperatures are outside acceptable parameters. All alarms should be taken seriously, and boaters should return to shore as soon as possible. Seek assistance from your authorized Axis dealer to determine the cause and solution to any problems that have been indicated.



Cooling System

All Monsoon engines feature a hybrid of raw water cooling and closed cooling. **Peak Sierra Brand, 5-year, 100,000-mile, Marine Grade Coolant (propylene glycol) in a 50/50 mix with distilled water is strongly recommended.**

From an empty tank to the proper amount of coolant/water mix will require approximately two (2) gallons. Directions for maintaining proper levels are provided in the *Care and Maintenance* section of this manual.

Without the need for a radiator such as used by land-based engines, the functionality of the cooling system is dependent upon operation within a body of water or maintaining the appropriate level of coolant/water in the system. Reducing operational heat from the engine is critical to ensuring the engine continues to perform. As Monsoon engines are configured, temperatures in excess of 200°F (93°C) are considered to be overheating situations.



CAUTION

NEVER run the boat engine with the boat out of a body of water! Even in closed cooling systems, some external water is used in the cooling process. Without water to circulate in the system, the engine will quickly overheat and can cause permanent damage that is not covered under warranty!

CAUTION

Be certain to read the Care and Maintenance section of this manual for important information regarding routine and regular functions that must be performed. Some of these tasks overlap engine and boat component attention and should never be skipped. Failure to perform care and maintenance can result in damage to the boat and engine that is not covered under warranty.

CAUTION

Regularly review the engine temperature information provided on gauges or video screen. Warning lights and alarms also are part of the system to provide early warning when engine temperatures begin to exceed acceptable levels. Continuing to operate a boat that is overheating the engine and powertrain will result in engine failure eventually. Ignoring or failing to take proper steps to reduce the engine temperature, resulting in damage, is not covered under the warranty.

If an engine overheats, consider several factors before shutting down. **(Turning off the engine when it is overheated may not provide immediate relief, and in some instances can actually cause additional harm.)**

If the boat has been idling for a prolonged period of time and the engine became overheated, attempt to reduce the temperature by operating the boat at a higher speed, preferably at normal running speed. This will increase the speed of water flowing through the cooling system, assuming there is sufficient fluid.

If the boat has been running at a higher rate of speed for a prolonged period of time and overheats, reduce speed for a few minutes to see if the temperature reduces. Running at wide-open-throttle (WOT) for too long can challenge the cooling system.

If there is no immediately discernible cause for overheating, or if the temperature does not begin to descend back to the normal range, turn off the engine and carefully open the engine compartment **(but never if there is an odor of fuel)**. Ambient air should eventually cool the engine, but if there is resulting damage to the engine from overheating, it may not restart, and the boat may need to be towed to shore.

WARNING

Never directly touch an overheated engine. Temperatures can exceed 200° Fahrenheit (93°Celsius), which would cause instant and serious burns, even through gloves or clothing.

The water pumps on the engine that circulate water and coolant throughout the engine during operation are essentially inaccessible to the consumer. The circulation pump, which circulates coolant, is located on the bottom of the front-end accessory drive. If it requires attention, that should be done by a service technician at an authorized Axis dealership.



Another pump, the raw water intake pump, is utilized to bring in water from the body of water. The raw-water pump is located on the top of the front-end accessory drive, adjacent to the alternator. Its purpose is to draw and circulate water from the body of water in which the boat is operating to increase the cooling effect for the engine. Water is brought through the raw water pickup, which is located at the transom, next to the steering tiller arm. The entire cooling system is located on the front of the engine on the transom side.



As part of the routine annual maintenance, the raw water pump should be inspected, with particular attention to the impeller. The process for inspection is explained in the *Care and Maintenance* section of this manual. **If the boat is operated in shallow or brackish water, or if the boat is run aground, the impeller should be checked regularly. Silt, sand, dirt and weeds can accelerate the deterioration of the impeller.**

Axis boats are equipped with a flush kit. The process for properly using a flush kit is explained in the *Care and Maintenance* section of this manual.

NOTICE

Inspect that the flush cap is tight before every outing, or it will suck air and could damage the cooling system. Such damage is not covered under warranty.

Most often, the cause of overheating is either marine growth clogging the raw water intake or insufficient coolant/water. If there is debris, even in small amounts, in the body of water, during usage it is likely that some of the marine growth can accumulate in the cooling system.

To protect the system, a sea strainer is installed near the raw water intake and serves the purpose of keeping debris from entering the cooling system, causing eventual engine failure. As with any kind of strainer, it is necessary to regularly clean it so that water can flow unimpeded.

CAUTION

Except for the sea strainer and raw water impeller, consumers should not attempt to inspect or repair components of the cooling system. Most are inaccessible. All can be inadvertently damaged if not properly accessed, often necessitating specialized tools. Attempting unauthorized inspection or repair can void the warranty.

Coolant Requirements

In the closed cooling system, verify that there is sufficient coolant/water in the system. (Coolant and water may be required to be mixed, depending on the brand of coolant, most likely in a 50/50 mix.) Because a closed cooling system retains and recirculates coolant an additional step prior to every outing is necessary: Before starting the engine, while it is still cool to the touch and does not burn skin, check the coolant reservoir level. The instructions for this critical step are explained in the *Care and Maintenance* section of this manual.

NOTICE

NEVER use ethylene glycol or Dex-Cool antifreeze coolant. These types of coolants are not formulated for the requirements of the Monsoon engine. NEVER mix the approved propylene glycol coolant with any other type of coolant, including ethylene glycol or Dex-Cool, even in small amounts. In fact, these different formulations do NOT mix and will not provide the required cooling protection for the Monsoon engine. Mixing coolants has the potential to damage the cooling system.

Axis recommends using Peak Sierra Brand, 5-Year, 100,000-mile Marine Grade Coolant in a 50/50 mix with distilled water to keep the warranty in effect. Peak Sierra is an environmentally friendly coolant.

While some evaporation occurs naturally, it should not occur at an accelerated rate. If a closed cooling tank has significantly lost coolant, especially if it is nearly empty, a potentially serious issue exists. Present the boat to an authorized Axis dealer for analysis and correction, prior to starting the engine.

NOTICE

Coolant should be flushed from the system and fully replaced every three (3) years or 1200 hours on the engine, whichever comes first, and the cooling system should routinely and carefully be checked for any leaks.



Exhaust System

DANGER

Always operate the blower for several minutes (at least four [4] minutes) prior to starting the engine, running at a low speed or at idle. (Axis boats are equipped with an automatic shut-off when the automatic blower system has operated prior to starting the engine.) This must be done with the engine compartment open. Failure to perform this necessary function could result in an explosion of the accumulated fumes within the compartment, resulting in serious injury or death.

Always operate the blower for the required four (4) minutes prior to starting the engine, ensuring the engine compartment is open. This should also be done when idling or running at low speed. This allows the disbursement of fumes that otherwise allowed to accumulate could result in an explosion.

The blower is controlled from the command center. (See *Dashes and Video Screens* section of this manual for more detail on how to operate the system.) **The blower should come ON automatically when the system is first powered up. However, operators should always verify that the blower is ON and operating rather than relying on the automatic ON.**

Although the Axis fuel system works very efficiently, there will always be some gaseous by-product as a result of operating an internal-combustion engine. These gases, along with the water used to cool the engine (in addition to the closed cooling system) are routed out of the boat by way of the exhaust manifolds on each side of the engine, and it is expelled out of the system at the transom.

DANGER

Never allow anyone to be on the swim platform, transom seating or sun pads when the engine is running. Carbon monoxide fumes are colorless and odorless. Illness and death can result from breathing fumes, even before a person is aware of breathing them. See the *Safety* section of this manual for more information regarding this critical matter.

Although much of the exhaust is dispersed into and through the water, fumes still reach the swim platform and transom area of the boat, including the sun pads. Therefore, no one should ever be on the swim platform, transom seating or sun pads when the engine is operating.

Always allow the exhaust manifolds to cool before touching them. (The manifolds are on the upper side of the engine on both sides.) Engine operation will result in the manifolds becoming very hot, and touching could result in burns to the skin.

NOTICE

Engines equipped with catalyst exhaust manifolds may produce an unusual odor. This is typical of engines with a catalytic converter exhaust system. If you are uncertain about any odor, do not hesitate to contact an authorized Axis dealer for assistance in determining the cause and potential for concern.

The boat is also equipped with a natural air-intake that forces air through a ventilation system on the deck of the boat. This channels air from the bilge to the transom vent.

With proper maintenance, which is the responsibility of the boat owner and/or operator, the ventilation system works efficiently and protects the people on-board from dangerous fumes. Follow the maintenance requirements as indicated in the *Care and Maintenance* section of this manual.



DANGER

DO NOT allow the ventilation intake to be covered up by towels, swim paraphernalia or any other item that potentially restricts the inflow of air for the proper ventilation of the blower system. Such restrictions can result in the accumulation of toxic fumes, which can lead to an explosion under certain circumstances. All types of restricted ventilation are dangerous and can lead to serious injury or death!





WARNING

The State of California has determined that the engine exhaust contains chemicals that have been known by the State to cause birth defects, cancer or other reproductive harm.

Never operate the boat if you or anyone on board suspects that the exhaust or fuel system is not performing as designed.

BREAK-IN PERIOD—BOATS

Breaking in marine engines is a different process from land-based vehicles. The first ten (10) hours of operation for your Monsoon engine is critical for long life and enjoyable operation. When done properly, the break-in period will ensure peak performance.

The first hours of the boat operation have critical requirements for engine break-in. Pay close attention to the video screens and monitor the readings. Pay particular attention to the oil pressure and engine temperature information as these are the earliest warnings when something is going wrong with the powertrain. Alarms will sound if serious problems are encountered.

Also, check carefully for leaks. The break-in period is the most-likely time for leaks to appear, whether fuel, oil, water or exhaust. Verify that fluid levels are at the required levels. Listen for abnormal noises and pay attention to vibrations.

Any part of the operation that seems to be different from expectations should be checked with your authorized Axis dealer, especially during this break-in period.

Break-In Procedure

All Axis boats undergo a general pre-test run at the factory before shipping. The customer-based break-in period takes place for the next ten (10) hours of operation. (The video screen includes an hourmeter function that allows consumers to keep track of the number of hours the boat has been in operation. See Dashes and Video Screens in this manual for details.)

NOTICE

Failure to have the initial, 10-hour oil change performed by an authorized Axis dealer may result in the voiding of the engine portion of the warranty if it is determined that engine issues could have been analyzed and/or prevented through the dealer's inspection at that 10-hour engine oil-change time.

The break-in procedures, which should be followed for the first ten (10) hours of operation as measured by the integrated hourmeter, allow the engine and transmission components to properly seat and function in the usage thereafter. These procedures are as follow:

- Always allow the engine to warm up after it is started. The length of time varies depending upon conditions, but it is especially critical when operating in colder weather. Oil viscosity thickens at these times. Failure to allow it to warm up can cause severe damage to the engine, which is not covered under warranty. **This is time in addition to the four (4) minutes venting the engine compartment.** Engine temperature is available on the video screen. Always verify that the engine feedback information on the video screen is within acceptable limits and no alarms show or sound before leaving the dock. Often, symptoms of potentially stranding issues will be noticeable at the beginning of the outing.
- Vary engine speed, but **DO NOT EXCEED 3500 RPM** with light load for the first hour.
- After the first hour higher RPMs are allowable **up to, but not exceeding, 5000 RPM, but operators must avoid operating at one continuous speed (RPM).** Varying the speed is important! **NEVER RUN AT WIDE OPEN THROTTLE (WOT) DURING THE BREAK-IN-PERIOD!**
- Never operate at idle speed for extended periods during the break-in period. Occasionally, return the shifter/throttle to neutral for a cool-down period, but do not operate at idle speed for extended periods. It is better to turn OFF the engine than to idle indefinitely.
- Operate above 1500 RPM carefully. If the body of water is choppy or if there are other challenges present, operate at lower RPM. Boating conditions can add strain to powertrain operation.
- Always shift and accelerate smoothly during break-in. Avoid rapid operational changes. Plane the boat quickly as lower speeds can put more strain on the engine.
- **Do not do your first oil change before ten (10) hours or later than fifteen (15) hours.**



- **Do not load the boat to its maximum load capacity until after the first oil change. Maintain the correct oil level as measured on the dipstick during the break-in period.**
- Monitor the gauges and video screens closely as these are your first line of defense.
- Abnormal vibrations or unusual noises could be symptomatic of additional problems that are not registered by the gauges and video screens.
- The boat must be returned to an authorized Axis dealer for the first service/scheduled maintenance. The purpose is to allow a trained technician to interpret any signs of malfunction or anomaly that may have occurred. Catching these symptoms early is critical to avoiding potentially damaging events that might not be covered under warranty.
- The dealer will change oil and the transmission fluid, as well as check the cooling fluid, clean the sea strainer, and do an alignment check on the engine.
- Verify that the propeller remains properly mounted and undamaged. Propeller information is provided in the *How It Works* section of this manual.

 **CAUTION**

Never operate at wide-open-throttle (WOT) continuously, even after the break-in period. WOT allows boat operators to quickly get the boat out of potentially dangerous situations and is intended for only brief use. WOT places exceptional stress and strain on the engine and drivetrain components. It can also test the boat operator's ability to control the vessel. Loss of control not only could cause an accident that damages the boat but could also potentially injure persons onboard.

NOTICE

Check the engine oil level frequently during the break-in process. It is normal for the engine to use oil at this time, often at a greater rate than will occur later. The dipstick is located mid-block on the starboard side of the engine, between the intake and manifold. It has a circular yellow handle. Add only full-synthetic 5W30 engine oil for M-Series engines, and 0W40 for LT4 engines. **DO NOT USE ENGINE ADDITIVES AT ANY TIME. ENGINE ADDITIVES WILL VOID THE WARRANTY.**

At ten (10) hours (and never later than fifteen [15] hours), the engine oil and oil filter **MUST** be changed. Axis strongly recommends that this procedure be done by the authorized Axis dealer as the service technicians are trained to look for the difference between acceptable signs of engine wear as differentiated from abnormal. This can make the difference in ensuring a long life for your drivetrain.

If your dealer is not conveniently close by, instructions for oil and filter change procedures has been provided for oil changes **AFTER** the break-in, 10-hour oil change. After the break-in period, follow the instructions presented in the *Care and Maintenance* section of this manual.

NOTICE

Failure to follow break-in instructions can result in long-term performance issues or damage to critical components of the drivetrain. Such failure is not covered under warranty.

TRANSMISSIONS AND V-DRIVES

Transmissions

Monsoon engines are equipped with Velvet Drive transmissions. The internal gearing is an integral part of the boat's propulsion, but also what allows a measure of control when docking and loading on a trailer. Inside the housing are a series of gears controlled by the shifter/throttle arm on the side panel at the driver's helm. The shifter allows the boat to move forward, backward or remain fairly stationary. (Bear in mind that boats are not equipped with brakes nor is there a way in which boats can remain stationary in the fluidity of a body of water. Neutral stops propulsion, but not movement. See the *Get Ready* section of this manual for more information regarding this topic.)

The transmission is attached to the back of the engine, but it will be in the boat forward of the engine's orientation because in these types of boats the engine is turned around from direct drive boats and most land-based forms of transportation.

Transmissions normally require very little maintenance as long as the powertrain is operated in a sensible manner. Slamming the shifter into a gear or being too timid in moving it can damage the system. As noted in the *How It*



Works section of this manual, a brisk, confident movement is suggested. Getting up to plane as quickly as reasonable and returning the shifter/throttle to an appropriate speed for the body of water is best. Excessive weight and neglecting service can also adversely affect the system and contribute to damage.

After the first ten (10) hours of operation, as part of the authorized Axis dealer's review during the oil change will be a check of the transmission. How to do the required check of the fluid is explained in the *Care and Maintenance* section of this manual.

V-Drives

Unlike land-based vehicles, boats can operate with the engine in a 180-degree orientation from how it would normally set in the vehicle. In the Axis-type boat, this has been adapted into a superior form of propulsion, but it requires a V-drive, which is a system for boats that consists of two drive shafts, a gearbox, and the propeller.

The first drive shaft connects the rear of the transmission to a gearbox mounted in the center of the boat. The second drive shaft extends from the gearbox to the rear and out the bottom of the boat to where the propeller is mounted. (The propeller's functionality is described in *How It Works* of this manual, as part of the underwater gear.)

As with the transmission, the V-drive assembly is very durable and requires little routine attention. Your authorized Axis dealer will check it during the 10-hour oil change. Afterwards, it will require a periodic check, which is described in the *Care and Maintenance* section of this manual.



how it works

SAFETY FIRST

Fire Extinguishing Equipment

Even when surrounded by water, fire is a significant concern. In fact, because safe egress from the boat is limited if it becomes necessary to abandon ship, this issue reinforces the need for easily accessible PFDs.

When boating in the United States, boats of less than 26 feet in length are required to have at least one B-I-rated, hand-held fire extinguisher onboard and fully charged, unless there is an automatic fire extinguishing system installed. For boats over 26 feet in length, two (2) B-I extinguishers or one (1) B-II extinguisher is required. If an automatic fire extinguishing system is installed in a boat over 26 feet in length, one (1) B-I hand-held extinguisher is still required. An automatic system is available as an option on Axis boats. Hand-held units are not included in standard equipment so that the consumer can choose from a wide range of fire extinguishers, many of which exceed the minimum requirements. **If the boat does not have an automatic fire extinguishing system installed, the boat owner MUST purchase and install at least one B-I-rated fire extinguisher (two (2) B-I extinguishers or one (1) B-II extinguisher for boats over 26 feet in length).**

Fire Extinguisher Requirements				
Fire Extinguisher Type & Quantity	Vessel Length			
	< 16'	16'–26'	26'–40'	40–65'
One B-I (when enclosed compartment)	✓	✓		
One B-II or two B-I. <i>Note: fixed system equals one B-I.</i>			✓	
One B-II and one B-I, or three B-I. <i>Note: fixed system equals one B-I.</i>				✓

Most countries have fire extinguishing and suppression requirements for recreational boats. It is the responsibility of the boat owner and/or operator to determine the requirements for the body of water on which the boating will occur. To avoid citations and/or arrest, boaters should check with local governmental agencies regarding specific requirements and limitations for boating on the applicable body of water.

The automatic fire extinguishing system is mounted inside the engine compartment. In the event the system's sensor recognizes extreme heat in the compartment, the system will create a chemically fixed dry suppression material. In most instances, there is sufficient suppression material to suffocate the fire and its source. In the event of a fire, boat operators should immediately turn OFF the boat's engine, which will also shut down the pressurized fuel system.

An automatic fire extinguishing system has an LED-lighted indicator located adjacent to the throttle-shifter at the driver helm. As part of the routine safety checks as the boat powers up, the operator should verify that the extinguisher system indicator is active.



WARNING

Whenever fire extinguishers or suppression units have been used in fighting an onboard fire, a careful determination should be made whether it is safe to operate the boat. In most instances, it is advisable to have the boat towed to shore rather than risk additional fire or permanent damage to the drivetrain. The boat should be thoroughly serviced by an authorized Axis dealer prior to operation again. Operation prior to service could result in additional damage to the boat and may result in serious injury or death.

Following discharge of fire suppression material, the system will require recharging. If an automatic system has discharged, it is unlikely that the boat can be run. Axis recommends getting a tow to shore and having the engine compartment thoroughly cleaned and the fire suppression system recharged prior to running the boat's engine again. If hand-held units have been discharged, they will also require recharging. The chemicals in all fire suppression units can discolor upholstery and carpeting.

It is recommended that the boat be cleaned as soon as practical. The fire suppression manufacturers provide information regarding the proper and appropriate cleaning agents. Also, pay attention to the cleaning instructions provided in the *Care and Maintenance* section of this manual to avoid permanent damage to materials.

Even if systems are not discharged, fire extinguishers and suppression units require periodic maintenance. For a factory-installed automatic fire suppression system, a check of the system should be part of the routine annual maintenance.

Hand-held units should be examined regularly for rust, corrosion, damage, or leakage. Weigh the unit annually to be certain that it meets the minimum listed on the label. If it has been used, even partially, it should be recharged by a qualified fire-extinguisher servicing company.

When purchasing fire extinguishing and suppression units, Axis strongly recommends buying units that are prepared specifically for the marine environment. The standards for these units have been established by the U.S. Coast Guard and the American Boat and Yacht Council (ABYC). In other countries, follow the recommendations and requirements of local jurisdictions and boating authorities.

Axis recommends fire extinguishing and suppression more than the minimum requirements.

While an automatic fire suppression system is highly effective in most instances of an engine compartment fire, it is possible that a fire could occur in another area of the boat. **Therefore, Axis recommends always having a least one hand-held unit fully charged and onboard.**

Models: (Optional) Available on all models.

Emergency Safety Stop Switch

The emergency safety stop switch attaches to the boat operator by way of a lanyard for the purpose of shutting off the engine if the operator, for any reason, moves or is moved away from the driver's helm.



The emergency safety stop switch lanyard should always be connected between the switch and the operator when the engine is running. The purpose of the switch is to immediately shut OFF the engine if the operator moves away from the driver's helm. Without the driver's control, all persons onboard or other boaters in the area could be subject to serious injury or even death. Never operate the boat without the emergency safety stop switch lanyard connected between the switch and the boat operator. Axis recommends the operator of the vessel always remain at the helm any time the engine is running.

The switch assembly consists of an ON-OFF switch and a switch/lanyard clip. The engine will not start and/or run if the toggle is in the OFF position. Axis recommends the clip always be inserted in the toggle switch. Connected to the operator, if (s)he moves away from the controls, the clip will pull free, pulling the switch to the OFF position. If the engine needs to be shut down very quickly, it can be done so by pulling on the lanyard to release it from the switch.

To reset the switch after activation, reinstall the lanyard clip and flip the switch to the UP position.



Lighting

All Axis boats are equipped with multiple lights to assist boaters in low light situations.





Boat outings should conclude prior to dark. Visual sighting is critical to safe boating. In an emergency where the boat must be operated in darkness, use the boat's navigation and anchor lighting in accordance with local law and ordinances which may restrict the type of lighting to be used, plus sound signals, to alert anyone in the area, and proceed slowly. After dark, it may be impossible to see other boats, submerged hazards, or the shoreline, which can result in damage to the boat that is not covered under warranty, and serious injury or even death.

Emergency Back-up Key Switch

When the emergency back-up key switch is turned to the ON position, the Navigation and Anchor Lights will illuminate.

Models: All models

Navigation Lights

As required by the U.S. Coast Guard and most maritime authorities, recreational vessels should display navigational lights between sunset and sunrise, as well as other periods of reduced visibility. There is a green light on the starboard side and a red light on the port side, operated from a button on the dash panel.



Models: All models



Bow and navigation lights get hot during use, which could result in burns if touched. The light can remain hot for an extended period after it has been turned **OFF**.

Anchor Light

All boats equipped with towers will also have a 360-degree light on top for use at anchor. If the boat is operated in darkness, use the anchor light in accordance with local law and ordinances. This light is on whenever the navigation/anchor lights are on.



Docking Lights

These are an option that offer additional visual assistance. The lights are located around the bow area and provide white light to the front of the boat. The docking lights are operated from a screen icon. On all models, the control is ON-OFF.

Please note that boat operators are not allowed to operate docking lights while the boat is underway.

Models: (Optional) All models.

Courtesy Lights

The courtesy lights vary from model to model and are found in all areas of the deck from bow to stern, as well as inside storage compartments. The lights provide white light. These lights are LED and therefore bright without excessive heat. However, leaving them on for extended periods of time shortens the life of the bulb and can become warm to the touch. Axis recommends leaving the lights off unless they are needed. The lights operate from a screen icon. Some lights are activated from the Interior Light icon (e.g., side panel lighting) while others are activated from the Storage Light icon (e.g., glove box, observer seat compartment).

Models: (Optional) All models.

Underwater Transom Lights

Some models may be equipped with optional underwater transom lights, which are located under the swim board and add considerable brightness in the water. This is an added safety feature, particularly when swimming in shallow water. **Note that these lights are not allowed to be ON while the boat is underway.** These LED lights are intended to be operated under the waterline, and Axis recommends keeping the lights OFF unless submerged. While LED lights do not generate as much heat as many other lights, water cooling adds to the life span of the bulbs. The lights are controlled by the video screen icon.



Models: (Optional) All models.



Tie-Ups

Several methods of securing boats to shoreline and docks are available.

Although Axis does not provide rope for tie-ups as a standard provision, dock lines are available through www.malibuboatsgear.com. Also, many excellent marine aftermarket suppliers offer a wide range of rope for sale.

Axis recommends a two-strand nylon rope. (Three-strand rope may stretch too much and allow the boat to bump other objects.)

There are several different knots and hitches to secure boats to docks or shoreline. Axis recommends making the effort to learn these marine-intended knots and hitches. Consult with your authorized Axis dealer to determine which ones will work best in the tie-up application you will be using. Some hitches are intended for only short-term docking, while others work better for longer periods of inactivity. Always bear in mind wave action that may cause the boat to bump the shoreline (and scratch the hull, which is not covered under warranty), or bumping against a dock, or even potentially other boats (also not covered under warranty), when selecting the appropriate method to secure the boat.

Cleats

All boat models offer optional pop-up cleats. Where equipped, the cleats will be located below the windshield on each side of the deck, and near both rear sides. Some models may also have two additional/optional cleats mounted on either side of the front of the bow.



Although there are multiple marine knots, the cleat hitch is a special knot used to tie the rope to a cleat. If a line is not correctly secured on the cleat using a cleat hitch, it can work itself loose.

Pop-up cleats have two “horns” around which the line is tied. Begin by bringing the line past the center of the cleat on the outside beneath and wrap it around under both horns. Then bring the line across and back under the first horn again in a figure eight. Make another figure-eight loop around the second horn.

WARNING

Cleats are used to tie the boat to a dock or to hang fenders. They are not designed for any kind of towing, including other boats. Nor should they be used for anchoring, mooring, or lifting the boat; the only location structurally certified for such “strong point” requirements is the bow eye. Abuse of the cleats is likely to result in equipment failure that will damage the boat, which is not covered under warranty, and can also result in serious injury or death.

The pop-up cleats operate by pushing on the cleat. If it is flush with the deck, pull up the cleat for use; to retract, push on the cleat once more.

NOTICE

Axis recommends the purchase and use of fenders to protect the boat’s gel coat finish whenever a boat is at risk of contact with docks or any other object (for example, rafting up with other boats) that may damage the finish. This kind of damage is not covered under warranty.

If the boat will be moored for an extended period or where there is active wave motion, Axis recommends the purchase of fenders, also available from reputable marine suppliers. Fenders are available in a range of sizes and materials, but the goal is to protect the boat from damage because of motion against the dock.

Models: (Optional) All models.

Bow Eye and Transom Eyes

All boats are equipped with a single bow eye near the apex of the hull under the bow, and two transom eyes, which are located one each on the port and starboard sides of the transom. The semicircular or U-shaped metal connections are made from stainless steel to reduce the effects of rust and corrosion. On boats that are not equipped with cleats, these eyes (along with the transom grab handle and/or the tower tow point) are used to tie-up the boat, and no other part of the boat, including any interior components such as the windshield extrusions or grab handles should ever be used.



Models: All models.



NOTICE

Never tie up the boat, even temporarily, using any component of the boat except the bow eye, transom eyes and/or cleats (where equipped). Using any other component could result in damage to the boat that is not covered under warranty.

Horn

All boats are equipped with a horn. The purpose of the horn is to sound an alarm in the event of an emergency, and to draw attention as you maneuver the boat in areas where line of sight is questionable or in instances when attention seems warranted. The horn is activated by a button on the dash.

Models: All models.



Mirror

Even when accompanied by an onboard observer to assist in keeping track of passengers, skiers, boarders, and others engaged in activities, operators would be well advised to use a mirror as part of constant alertness to the surroundings.

All boats can be equipped with a windshield-mounted and adjustable mirror as an option.

Note that the mirror is held in place by a knob that is tightened. Unlike most land vehicles, the boat mirrors must have this knob loosened to adjust the mirror's field of vision, and then retightened to hold it in place.

Models: (Optional) All models.

NOTICE

Failure to tighten/loosen the knob on the mirror prior to adjusting the field of vision can cause damage that is not covered under warranty.

Fuel Fill

Axis boats are equipped with fuel fill fittings and vents to provide state-of-the-art safety protection in the process of adding fuel to the tank. While most of the fuel system on the boat is inaccessible to owners/operators, the fuel fill was designed to ensure the process of fueling is efficient and as safe as possible.

The fuel fill is located on the port side of the boat toward aft on all Axis models.

There should be no spit-back or overflow at land-based gas stations in North America. However, the requirements that eliminate those issues are not applicable to some gasoline service stations in other countries or even at some marinas in North America.

Therefore, care should always be taken while fueling the boat. Do not stand too close to the fuel fill location in case some fuel is expelled from the pressurized system. You may also hear an audible release of air pressure when opening the cap. Pay attention to ensure that gasoline is entering only into the boat's fuel fill and not spilling or running outside the fuel fill.

Note that the first time the boat's fuel tank is filled, the process may seem slow. This is because fuel is displacing air that was in the tank. After the first full tank, filling should proceed at approximately the same pace as one would expect in filling land-based vehicles.



! DANGER

Gasoline is extremely flammable. Under some conditions, particularly those that allow fuel fumes to accumulate in enclosed areas, gas can be explosive as well. Avoid smoking while filling the gas tank or allowing any sparks in the area. Never run the boat engine while filling the gas tank. If any gas is spilled, clean it up with clean rags and dispose of properly on land.



INTERIOR PERFORMANCE

Steering Wheel

Steering in a boat is different from most land vehicles, although the effect is similar. Axis boats are equipped with steering wheels. The standard steering wheel, which can be tilted, is turned in the direction the operator wishes to go. Instead of wheels turning in that direction, the boat steering wheel controls a rudder, and the rudder turns in the opposite direction. By cutting through the water with a rudder in the opposite direction, the bow of the boat will turn in the direction the steering wheel has been turned. Note that, compared to land-based vehicles, it takes more time to perform maneuvers on the water than it would on land. It is important for new operators to practice before trying turns in tight locations.

Boats also do not track in the same manner as land-based vehicles. They are affected by currents, wave action, and natural motion created by the propeller. At slow speeds, the effect is more pronounced, and boats seem to wander slightly. Trying to steer the boat back and forth to compensate only worsens the effect. If there is adequate water depth and no obstacles close at hand, allow the boat to follow its course. The overall course will be directionally straight if the steering wheel is held in place.

Axis boats are equipped with a tilting mechanism on the steering column. This allows the operator to adjust the steering wheel to the most comfortable angle and provide a sense of secure control. Steering columns have a lever at the underside of the column. Press down on the lever until the steering wheel is movable. Tilt it up or down to the best angle for the operator and reengage the lever snug against the steering column. Never force the lever. If it will not move with relative ease back into place, the steering wheel is not in one of its acceptable levels. Adjusting slightly should allow proper action of the tilt mechanism.



Communication is key to maintaining proper control of the boat. In models equipped with the Surf Band, it can take temporary control of the boat, affecting maneuverability and safety. A designated individual onboard should always manage who is operating these controls. Failure to do so could result in serious injury or even death because of loss of control.

Shifter/Throttle

Note: The engine will not start unless the shifter/throttle control is in the Neutral position!

To the right of the boat operator is the shift/throttle lever. Any time the boat engine is off, the lever should be in the center upright position, which is Neutral (meaning the boat is not in gear) and is apparent when it can be felt slotting in with an auditory click. Boats are not equipped with “Park” like land-based vehicles.

At the base of the throttle is a button. Pushing on the button disengages the transmission, thereby allowing use of the throttle without engaging the transmission. This is used for warm-up of the engine while it is still in Neutral. Be sure to position the throttle vertically (Neutral) before reengaging the transmission by again pushing the button.

When engaging the transmission from Neutral either forward or backward into reverse, pull up on the safety collar located directly below the throttle lever knob. The safety collar helps avoid unintentional movement into gear.

When shifting gears, always do so smoothly and briskly. Being either too hard and slamming the gears, or too tentative is hard on the shift/throttle system and can result in damage that is not covered under warranty.

Models: All models.





Do not shift from forward to reverse while the engine is at high RPM. Damage to the transmission will result. When shifting from forward to reverse, the system requires a brief pause in the Neutral position to allow the engine to return to its idle position prior to moving into the opposite gear. Without the brief pause, it can also cause the engine to shut off. The subsequent loss of control can cause damage to the boat and/or injury to persons in or around the boat.



Before starting the engine or engaging the transmission, be certain that there are no people in the water around the boat.

Electronic Throttle Control (ETC)



Never make any alterations or modifications to any part of the throttle control system, including the throttle control. Such changes render the engine and boat warranties void and may result in loss of control of the boat, which could result in serious injury or death.

Although unseen by the boat's occupants, the Electronic Throttle Control (ETC) contributes to the boat's performance in critical fashion. Never make any modifications to the throttle control.

If, for any reason, (unplugged, wire cut, a short, loss of power, or sensor failure, etc.) any part of the electronic throttle control system fails, the engine controller will default to idle. The operator will essentially have no control of the throttle and the Engine Fault Alarm will activate.

If this happens, the operator must turn the ignition key to OFF, and then attempt to restart the engine. This will reset the computer area network. If the condition persists, however, it will be necessary to take the boat to an authorized Axis dealer for repair.

Additional information regarding the throttle control's safe operation and maintenance is included in additional separate material that is part of the new boat information package.

Models: All models.

Pylon(s)

All models can have an optional pylon located between the lounge lean back seats and the sun deck area. These pylons, which are intended for use in wakeboarding and tubing as well as skiing, are not intended for any other use.

Models: All models.

NOTICE

DO NOT attempt to use the pylon for any purpose other than towing individuals behind the boat with an appropriate towing rope. **DO NOT** attempt to tow another boat by attaching a rope to the pylon. This will overload the pylons and can cause damage to the boat which will not be covered under warranty.



DO NOT allow passengers to sit behind the pylon whenever someone in the water is being towed. When the towed individual lets loose of the ski/wakeboard rope, the tension may cause the rope and its tow handle to snap back into the deck area. Individuals may not be able to deflect the rope, with the result that people hit by the rope and handle could be injured, especially if they are not paying attention.

INTERIOR LUXURY

Stereo Components

One of the most enjoyable aspects of boating is the stereo system, and Axis offers a range of optional media opportunities. Most of these systems are controlled through the main stereo head unit, but a stereo transom remote



is available as an option.

There are four levels to the stereo sound packs. Sound Pack 0 is a no-stereo option. Sound Pack 1 is a basic stereo that comes with a dash remote, four (4) interior speakers, and an amp. Sound Pack 2 features a dash remote, six (6) or eight (8) interior speakers (depending on model), amps and either two (2) or four (4) eight-inch (8") tower speakers. The premium stereo option is Sound Pack 3. This has a dash remote, six (6) or eight (8) upgraded interior speakers (depending on model), upgraded amps, and either two (2) or four (4) ten-inch (10") tower speakers.

Stereo system controls are explained in the *Dashes and Video Screens* section of this manual.

Models: (Optional) All models.

Seating

The standard Axis seating is crafted from top-quality materials and engineered to provide the maximum-allowed number of individuals onboard for the boat model's design. Please note that it is very important for passengers to be seated as shown in the seating charts in the *Quick Reference Guide* section of this manual. This provides for balance and avoidance of over-loading that could otherwise adversely affect the boat's ability to maneuver, swamp the boat or even cause injury or death.

Axis also offers a sliding skybox seat, available on some models. To operate, pull the grab handle from the center of the cushion, pulling backwards until it locks in place within the track system. The skybox seat option can optionally be equipped with lean back cushions, which can be found inside each engine hatch cover. To set up the cushion, pull the retractable pin and swivel the anodized arm ninety degrees (90°) until the pin locks in place.

To fully seat the anodized arms of each lean back cushion, pull the pin on each side of the skybox seat. When the arms are fully inserted, replace the pins to fully secure the cushion. Be cautious to avoid pinching fingers or other skin.

No one should sit or ride on the sun pads when the boat engine is running. Carbon monoxide is emitted from the exhaust system and vented into the water beneath the swim platform. Fumes can and do reach the sun pad area. Avoidance of carbon monoxide poisoning is addressed in the *Safety* section of this manual.

It is critical to the long-term use and enjoyment of the boat to perform the routine maintenance required to keep all interior upholstery in top condition. Details are provided in the *Care and Maintenance* section of this manual.

Models: Seating varies by model. Check the Quick Reference Guide in this Owner's Manual. The skybox seating is available on the models A245, T220, T235, T250.

DANGER

Failure to evenly distribute the combination of passengers and additional gear brought on board can result in loss of control of the boat, swamping and sinking, and causing other adverse effects. Never exceed the boat capacity, paying particular attention to limits in bow seating. Failure to pay ongoing attention to this can result in serious injury or death.

WARNING

Never attempt to jump into the body of water from any of the seating in the boat. It can be difficult to determine water depth, and it could be possible to misjudge clearance of the deck and gunwales.

CAUTION

Avoid pinching fingers or skin in raising or lowering cushions while accessing storage compartments and the engine compartment.

Glove Box

Axis recommends storing this manual in the glove box so that it will always be readily available for reference during outings. Placing this manual in a plastic bag will increase its protection.

The glove box is convenient for storing personal items while boating as well. **While the glove box is not waterproof, its**



design reduces the likelihood of damage from water that may come on board. Axis does not warrant the level of water resistance available when using the glove box.

The glove box opens by pushing on the button on the front of the lid. Closing requires only shutting the lid tight. Closing requires minimal effort. If more effort is required, it is likely the glove box is overloaded, and some material should be removed prior to closing.

NOTICE

Never attempt to close an overloaded glove box. Trying to force the lid closed could result in damage that is not covered under warranty. Avoid pinching fingers, hands, and other body parts while closing the glove box lid.

Do not store any aerosol items in the glove box. These can overheat and leak and/or rupture. Any liquid or semi-liquid material placed in the glove box may spill or overheat. Care should always be used when placing liquids such as suntan lotion in the glove box. Axis is not responsible for such misjudgments.

Should any water intrude into the glove box, clean it out as soon as practical. Mold and mildew can result if even small amounts of water are not removed. As with any storage location, any spills should be cleaned efficiently to avoid damage and/or odors.

Models: All models.

Storage Compartments

Axis boats have multiple storage compartments available throughout the boat. In general, storage is available in the bow, gunwale, and floor. Some models will also have transom storage and may have interior lighting within the storage compartments.

As much as possible, gear and property brought onboard should be stowed in storage compartments to prevent movement of items during the outing. Unsecured items could strike and potentially injure individuals on board during operation.

Be sure to distribute items throughout the boat and compensate for the persons on board. Weight should be as evenly distributed throughout the boat as possible to avoid negatively affecting control.

Never try to close an overloaded storage compartment. Forcing a compartment closed can result in damage to the boat that is not covered under warranty.

Storage compartments should be cleaned out in accordance with the *Care and Maintenance* instructions in this manual. At least annually, all compartments require a thorough cleaning. If anything with residual odor is placed in a storage compartment, or if anything has spilled in the compartment, cleaning should occur as quickly as possible afterwards.

DANGER

Anything brought on board should be stored in a designated storage compartment, if possible, to avoid the potential of being struck by an unsecured item while underway. This could result in serious injury or even death. Items should be evenly distributed and with attention to the number of passengers and where they will sit. Even distribution of added weight is critical to a safe operation.

NOTICE

Never force a compartment closed as overloading could cause damage to the boat and that is not covered under warranty. Storage compartments should be kept clean. Failure to do so may result in damage or permanent discoloring and/or odors that are also not covered under warranty.

Models: All models.

Removable Cooler

Adding more convenience is a marine-grade, removable cooler. Any cooler of the same or smaller size will fit in the same location, which is on the port side behind the side seating on the A245 and T250, and on the starboard side behind the helm on all other models. Axis recommends marine-grade coolers as they use stainless-steel hardware,



which is advisable in the type of atmosphere in which it will be used. Although the supplied cooler has a liner that reduces odor absorption, it is a good idea to clean out the cooler after each use. Odors may still penetrate, and spills can stain. Such occurrences are not covered under warranty.

Models: All models.

Cup Holders

All boats are equipped with cup holders. The cup holders are sized for contemporary, normal-sized cups. Axis recommends using only cups with covers as boat motion is likely to otherwise slosh liquids out of the cups. If liquids are spilled into the cup holder, or anywhere else, they should be cleaned up as soon as practical to prevent any damage to the boat components or anything brought on board. Such damage is not covered under warranty.

Models: All models.

Soft Grip

Soft Grip adds comfort and an attractive appearance to the interior. Be aware, however, that it requires some additional maintenance. It is important to allow Soft Grip to dry before covering the deck with a mooring cover or other canvas. Although Soft Grip is constructed from marine-grade materials, if it does not dry thoroughly before storage, even short-duration, mold and mildew can set in. Additional information is available in the *Care and Maintenance* section of this manual.

Models: All models.

WARNING

Boaters should use caution when walking on Soft Grip that is wet. Soft Grip can be very slippery, and falls could result in serious injury.

Grab Handles

Boats are equipped with grab handles for added convenience and safety. Handles are generally inside the deck above passenger seating and on the transom, centered above the swim board. The handles assist boarding, particularly from the swim board into the deck area. During boat operation, the grab handles inside the deck can provide additional security for passengers. (No one should ever be on the swim board during boat operation. You can read more on this in the *Safety* section of this manual.) The handles are crafted from stainless steel or anodized aluminum to resist rust and corrosion. Routine maintenance should include regular cleaning.

Models: All models. Locations vary. Operators and passengers should acquaint themselves with the locations prior to operation.

WARNING

Interior grab handles may be used by passengers to hold on to during boat operation. The handles are sturdy surfaces, which means that if an individual makes sharp contact with a grab handle, bruising may result. If the boat is being operated in a manner that results in excessive movement of the passengers, or if people are shoving each other, even playfully, at any time, injury is possible. Axis strongly recommends that this kind of activity be always avoided. Do not use the handles to secure or tie up the boat as this can cause damage that is not covered by warranty.

Heater

A popular option on all models is the heater. Warm air is vented to the deck from the engine core. Vent locations vary by model, so owners/operators and passengers should familiarize themselves with the locations. The vents have sliding, directional gates that can redirect the air flow, or even shut it off.

The heater is controlled on the video screen. To turn it on high speed, on low speed, or off, review the instructions that are provided in the *Dashes and Video Screens* section of this manual.



! DANGER

Never operate the heater within a confined space. This includes with a canvas cover over the cockpit or bow area, with the stern of the boat in a shallow area, or at the dock/shore with other boats or docks close by. Any situation in which exhaust fumes are trapped or limited in disbursement could result in carbon monoxide fumes within the deck and could result in carbon monoxide poisoning. Carbon monoxide poisoning is addressed in the Safety section of this manual. Be aware that operation of the heater is a drain on the battery.

Review the Electrical section in the *Dashes and Video Screens* section of this manual for important information regarding how to avoid becoming stranded by a fully discharged battery or batteries. Pay attention to the voltmeter reading; whenever it falls below 10.5 volts, the battery requires recharging. Propylene glycol (a specific type of antifreeze) runs through the heater core. This is addressed in the *Care and Maintenance* section of this manual.

Also note that air coming through the vents may be cool initially, depending on whether the engine has warmed up. The hot water to heat the heater core is pulled from the engine. Therefore, the engine must be running to have warm air flow from the heater. Allow a reasonable period for the air to warm. However, if it has not warmed after several minutes, it may signal an issue with the heater system. This will require attention from an authorized Axis dealer.

TOWER, CANVAS, AND ACCESSORIES

There are two different models of the Axis tower; the standard tower and the shock package tower. If the tower has knobs in the base it has the shock package. Both versions of the tower fold down; however, with the shock package, lowering the tower is much easier because the shocks take most of the load for the tower. With the shock package, the knobs can be used to lock the tower in the down position for trailering. If the tower does not have the shock package, you cannot trailer it in the down position unless the purchase included the Tower Support Pole (PN 6170097.1).

Lowering the Tower

- Step 1: Prior to lowering the tower, stow the Bimini and fold the board racks inward.
- Step 2: If the tower has knobs in the bases, remove them.
- Step 3: Unlock the toggle latches on the hoop.
- Step 4: Flip the small gray levers up that are in the base. If they do not flip up easily, try pushing the side support inboard slightly. (“Axis” is machined into them.)
- Step 5: Rotate the hoop forward slightly and push the side supports outboard.
- Step 6: Lower the hoop until it stops.
- Step 7: If the tower has knobs, reinstall them into the bases.
- Step 8: Flip the side supports inboard.
- Step 9: Flip the small gray levers back down. If the tower has the shock package, the tower is ready to trailer.



To raise the tower, perform Steps 1–9 in the reverse order.

! CAUTION

Adding any tower to an Axis boat other than an Axis-built tower will void the warranty. Due to the complexity of adding a tower, the stresses on the deck and the potential for injury if the tower fails, Axis strongly discourages the addition of a post-boat-construction tower.

On the Axis tower, the toggle latch, during operation, must be secured on each side as shown in the photos.

To raise or lower the tower, Axis strongly recommends a second person to help steady the tower into position. The tower’s weight could cause loss of control, resulting in damage to the boat or potential injury to person(s).

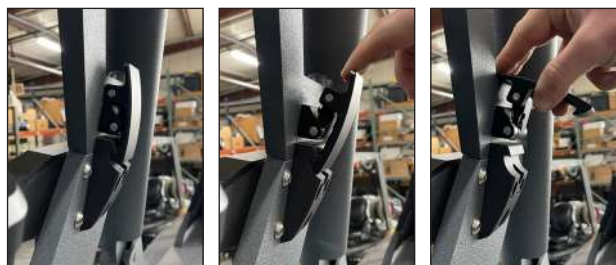



Always ensure that the toggle latch on each side is secure prior to any outing. If a latch is left unsecured, the tower will become unstable and could fall on individuals or become dislodged while towing, if the tower is upright. In opening and closing the toggle latch, take care to avoid pinching fingers, hands or parts of the body.



A second person to assist in raising or lowering the tower is strongly recommended. Due to the weight and angle of the tower, a lone individual could lose control, resulting in damage to the boat, which is not covered under warranty, and/or injury to people in the tower's range of movement.

Tower Accessories

Following are descriptions of a variety of optional accessories that can be added to the tower, depending on packages and availability. It is important to note that the towers were designed to accommodate only the specified options. Other aftermarket options may not work properly due to the electrical harness requirements. The towers can also hold only a limited amount of weight. Exceeding that limit can cause failure of the tower, which could lead to injury to people on board or people using the tower for water activities. No additional weight should ever be added to the tower.

Models: Optional on all models.



No components should be added to the Axis tower beyond what is specified by the company. Other aftermarket items may not be acceptable due to electrical, electronic, or other wiring and power-related issues. The tower weight limit may be exceeded by adding aftermarket items. Such weight limits can also cause the tower to fail, which could result in damage that is not covered under warranty, as well as serious injury or even death to persons on-board. Never suspend any additional items from the tower. No one should ever be allowed to sit or stand on or hang from the tower. The design will not support such activity and, again, could result in serious injury or death.



Inflatables should not be towed from the tower. The impact forces from inflatables may do damage to the tower or fiberglass hull of the boat, which is not covered under warranty. Injury may also result.

Bimini Top

One of the most popular options is the Bimini top, which provides protection from the sun for the driver, observer and may also offer shade to others on-board, depending on the sun's angle. It also provides storage for ropes. The deluxe version also offers surfboard storage.

The canvas cover requires thorough drying prior to the boat being stored. See the *Care and Maintenance* section of this manual for additional information.

There are two Bimini options for Axis, the Apex Slider Bimini Top (dual coverage) and Great Lakes or Apex Forward Mount Biminis.

To Open the Apex Slider Bimini Top (Dual Coverage) for Use:

- Step 1: Unclip the strap wrapped around the tower and unwrap from around the tower.
- Step 2: Pull the Bimini aft and free of the tower until it will not slide any farther.
- Step 3: Unzip the Bimini boot and place the boot in a secure location, preferably one of the storage compartments.
- Step 4: Unroll the canvas from around the Bimini support bar.
- Step 5: Pull the canvas over the tower, ensuring the opening fits over the navigation light.
- Step 6: Unfold the Bimini frame toward the bow.
- Step 7: Secure the two support rods. (Gently pull down on the Bimini canvas to release tension and make it easier to hook the rods.)
- Step 8: Wrap the four connection straps around the bars and secure with the Velcro flaps.



- Step 9: Clip the two straps around the tower.

To Close the Apex Slider Bimini Top (Dual Coverage):

- Step 1: Open the Velcro flaps on the four connection areas and unclip the two straps around the tower.
- Step 2: Release the two support rods. (Gently pull down on the Bimini canvas to release tension and make it easier to unhook the rods.)
- Step 3: Fold the front half of the Bimini aft.
- Step 4: Pull the canvas over the tower, taking care while moving it over the navigation light.
- Step 5: Roll the canvas around the Bimini support bar.
- Step 6: If the boat will be in motion, place the Bimini boot over the canvas and zip it closed. (This will keep the canvas from flapping during operation and potentially tearing it, which is not covered under warranty).

For Towing with the Apex Slider Bimini Top (Dual Coverage):

- After closing the Bimini top as explained immediately above, slide the Bimini forward until it will not slide any further. It should be behind the tower.
- Slip the canvas strap around the tower/Bimini and clip closed to hold the Bimini to the tower.

To Open the Great Lakes or Apex Forward Mount Bimini for Use:

- Step 1: Unclip the strap wrapped around the tower and unwrap from around the tower.
- Step 2: Rotate the Bimini forward toward the bow, unzip and remove the boot, and unwind the canvas. Place the boot in a secure location, preferably one of the storage compartments.
- Step 3: Make sure the support arms are secured at the top of the tower. The Apex Bimini will have a straight support bar that is held up at the front of the Bimini with Velcro. A Great Lakes Bimini will have two bars with a joint on either side—these can always be left secured to the top.
- Step 4: For a Great Lakes Bimini, pull the canvas over the top of the tower and zip up the flaps in the various locations. For an Apex Bimini, pull the canvas over the top of the tower, wrap the Velcro straps around the tower in the various locations and secure to itself. The Velcro can be used to help tighten the Bimini canvas.

To Close the Great Lakes or Apex Forward Mount Bimini:

- Step 1: Remove the canvas from the top of the tower. On Great Lakes, unzip the flaps and pull the canvas up and over the pylon/navigation light. On Apex, undo all of the Velcro straps.
- Step 2: On Apex, remove the support poles from the top of the tower and Velcro them to the front of the Bimini where the Velcro strap is included.
- Step 3: On either Bimini, the canvas around the frame can be wound until it is tight.
- Step 4: Follow this by placing the boot back on and zipping it up.
- Step 5: Finish by placing the Bimini back against the tower and wrapping the straps around the top of the tower and securing the clips. The Bimini is now ready for trailering.

Icon 8 or Rev 10 Tower Speakers (2 or 4)

The ICON 8 tower speakers from Wet Sounds are an extreme performance component designed for those who crave a full mid-bass sound and clean, detailed highs in a small form factor. The ICON 8 is designed for full sound in and around the boat and while wakesurfing, allowing for enjoyment while on a wave, without missing the tunes.

The ICON 8 utilizes an eight-inch (8”) continuous cone mid-bass driver with a grille-mounted pure one-inch (1”) titanium tweeter in a smaller-form factor housing.

With the REV 10 tower speakers, enjoy the best, full-range sound quality on and off axis at long distance while riding behind the boat. The REV 10 tower speaker uses a high-performance woofer, with a Kevlar-reinforced cone and polyurethane surround for extra strength. Powerful highs from the titanium horn-loaded compression driver will provide crisp sound clarity at high volume levels.

Each tower speaker can be configured with two (2) or four (4) speakers. The ICON 8 or REV 10 tower speakers are available only in Matte Black or Matte White finish.

Models: The speakers and configurations vary from model to model.

Clamping Spinner Board Racks or Ski Rack

These aerospace-grade, anodized-aluminum swivel racks are corrosion resistant and ratchet down with a slight tug on the single lever, securing the wake items. Be sure that boards are securely in place prior to operating the boat, as they can become projectiles if they are not. Also, remove boards and stow inside the boat before trailering. Highway



speeds can cause damage even if the boards are secure on the rack.

The ski rack accommodates two slalom skis with easy access bungee forks to free up storage areas onboard. The ski racks can be mounted on either the port or starboard side of the tower, or on both.



Secure boards and/or skis on the rack prior to operating the boat. If they are not secure, the boards and/or skis may come off the rack and become projectiles that could damage the boat or hurt individuals. Remove them from the racks and stow in the boat when trailering. Even if secured on the racks, highway speed can cause damage to the boards, skis, tower or boat, or even cause them to become loosened from the racks. Spinner racks should be locked prior to towing.

Mounting Wakeboard on Clamping/Pivoting Racks:

- Step 1: Pivot the rack inward by pulling down on the pivot release knob and moving the rack to the inward position. It will lock in place.
- Step 2: Place the board in either the top or bottom slot and center the weight of the board in the middle of the rack.
- Step 3: After the board is in the proper position in the rack, gently pull down on the left and right clamping fork handles simultaneously until the board is secure.
- Step 4: Pull down on the pivot release knob again and pivot the rack to the outward position until it locks in place.
- **NOTE:** The rack can pivot and lock in three positions: inward, center, and outward.

Removing the Wakeboards on Clamping/Pivoting Racks:

- Step 1: Pivot the rack inward by pulling down on the pivot release knob and moving the rack to the inward position. It will lock in place.
- Step 2: Press the clamping release buttons to release both clamping fork handles.
- Step 3: Remove the board from the rack.
- Step 4: Pull down the pivot release knob again and pivot the rack to the outward position until it locks in place.
- **IMPORTANT: Before pulling into a dock, be sure to swivel racks inward to prevent damage to racks and the dock!**

Tower Mirror

Housed in an aluminum billet with an adjustable arm, the optional mirror offers high-definition, prescription-grade optics with a 140-degree field of view.

The mirror is adjustable by way of a clamp on the tower. The mirror should be removed and stowed in a storage compartment inside the boat if the boat will be towed any substantial distance.

Models: (Optional) These accessories are available as options on all Axis towers. They may be supplied as part of a package.

ON AND UNDER THE WATER

Blower System

One of the most critical elements of the boat is the blower system. There are important things to remember when operating the boat:

Always operate the blower for at least four (4) minutes prior to starting the engine, ensuring the engine compartment is fume free. This should also be done when idling or running at low speed. This allows the disbursing of fumes that otherwise allowed to accumulate could result in an explosion.

The blower is controlled from an ON-OFF switch on the video screen. See the *Dashes and Video Screens* section of this manual for more detail on how to operate the system. The blower should come on automatically when the system is first powered up from the ON-OFF power button. However, operators should always verify that the blower is on and operating rather than relying on the automatic ON.



Always operate the blower for several minutes (at least four [4] minutes) prior to starting the engine, running at a low speed or at idle. This must be done with the engine compartment open. Failure to perform this necessary function could result in an explosion of the accumulated fumes within the compartment, resulting in serious injury or death.

The purpose of the blower system is to vent carbon monoxide, a naturally occurring by-product of the engine and



drivetrain operation to remove dangerous carbon monoxide and other naturally occurring toxic byproducts from the engine and drivetrain operation. The emissions primarily are eliminated through the surf pipe located beneath the swim platform and transom area of the boat, including WakeView seating and the sun pads. Therefore, no one should ever be on the swim platform, transom seating, or sun pads when the engine is operating.

 **DANGER**

Never allow anyone to be on the swim platform, transom seating or sun pads when the engine is running. Carbon monoxide fumes are colorless and odorless. Illness and death can result from breathing fumes, even before a person is aware of breathing them. See the Safety section of this Owner's Manual for more information regarding this critical matter.

 **WARNING**

Always allow the exhaust manifolds to cool before touching them. (The manifolds are on the upper side of the engine on both sides.) Engine operation will result in the manifolds becoming very hot, and touching could result in burns to the skin.

NOTICE

All engines are equipped with catalyst exhaust manifolds that may produce an unusual odor. This is typical of engines with a catalytic converter exhaust system. If you are uncertain about any odor, do not hesitate to contact an authorized Axis dealer for assistance in determining the cause and potential for concern.

Bilge System

Another critical component in the safe operation of the boat is a properly functioning bilge system. The bilge is a void between the deck and hull in which unintended water accumulates as it is drained from other areas of the boat. It does not include the water in the ballast system, which is deliberately added to the boat and must be dealt with separately.

As noted in the *Care and Maintenance* section of this manual, the bilge should be routinely checked and drained, as necessary. The automatic function will often keep the system free of excess water. Too much water in the system can affect the boat's handling under operation, and can potentially swamp a boat, causing damage to other components in the bilge compartment.

All boats have at least one bilge pump in the center of the boat directly below the center pie plate. If a second bilge pump is equipped, it will be located at the transom of the boat, aft of the engine on the starboard side.

Bilge pumps can be turned on manually or automatically. To turn on the pump manually, use the controls on the screen. See the *Dashes and Video Screens* section of this manual for additional information on operation through the screen. The bilge pumps are also equipped with a sensor to automatically turn on if water is sensed around the pump. This function is always active. The automatic mode will always be activated, even if the battery isolator switch is turned to the OFF position. Therefore, be certain the pump is working properly and there is no kink in the output hose before storing the boat for long periods of time since the bilge pump will continue to run if it senses water. Otherwise, this could cause a battery to drain and could ultimately damage the pump over time.

Operators should always check that the drain plugs are installed and secure prior to every operation.

 **WARNING**

Drain plugs must always be checked to be certain they are securely installed prior to every outing and operation. Visual indicators are not validation that the plugs are installed, but rather serve only as assistance in the process. Failure to install the drain plugs will allow water to intrude into the boat and can result in flooding, swamping, and sinking the boat. Such action could result in damage to the boat that is not covered under warranty, as well as serious injury or death to persons on board.

NOTICE

After manual operation of the bilge pumps is complete, use the screen controls to return the bilge pump(s) to automatic mode. If the bilge pump is left in manual mode and there is insufficient water in the bilge, the bilge pump will eventually fail. Such a result is not covered under warranty. Axis recommends testing the function of the bilge pump prior to each use of the boat. This can be done by simply turning the pump(s) on and making sure they are running.



There will likely always be a small amount of water in the bilge, as the pump cannot eliminate 100% of the water. A minor amount of water is acceptable. However, operators should monitor bilge water levels through the center access pie plate. In all models, this hole is in the center of the deck near the driver's helm. It may be under a mat. It should remain secure during operation and opened when the boat is stationary and the engine not running. Be certain to close the pie plate before operating the boat again. Individuals on board could trip and injure themselves if the pie plate is not secured properly.



All boats are equipped with two drain plugs, a 1/2" drain plug on the transom and a T-handle drain plug in the center of the boat. The 1/2" drain plug can be accessed outside the boat, directly under the swim platform on the center back of the transom. The T-handle can be accessed inside the boat through the center access. Be certain to read the above information regarding **SECURELY** installing drain plugs prior to all outings.

The transom plug is in the center of the transom at the bottom edge.

NOTICE

The bilge system plugs should be removed at the conclusion of any boating outing in which the boat is removed from water. This assists in the draining process. Axis recommends keeping the handles stored in a designated storage compartment on a routine basis so that they are always easy to locate prior to the next outing. Never launch a boat without ALL the drain plugs reinstalled; this should be part of the routine checks prior to launching the boat into the water. Failure to reinstall the drain plugs will result in water entering the bilge system and can sink the boat.

During storage or winterization, the batteries should be removed. This will cause the automatic bilge system to be temporarily inoperable. This adds to the importance to never leave the boat in a body of water without a fully charged battery installed.

Because of the frequent use of the bilge pump and its importance to the safe operation of the boat, the bilge pumps, which are in the center bilge area below the pie plate and engine (aft) area, should be checked by an authorized Axis dealer as part of an annual maintenance routine.

NOTICE

Automatic bilge systems require a small amount of electrical charge, which is drained from the battery or batteries on board. Eventually, the battery could become fully discharged, which means that the automatic bilge will no longer work. If the boat is left in a body of water during this period and water continues to enter the bilge system, water is not drained. This could lead to damage to components in the bilge and potentially to the rest of the boat. Such damage is not covered under warranty. Therefore, if a boat will be left unattended for a period, owners/operators should make regular checks of the system to ensure that the battery retains a charge.

⚠ DANGER

If the bilge system is not operating properly when a boat is launched, **DO NOT** continue with the outing. If the bilge system ceases to function properly during an outing, have all persons on board put on a PFD if they are not already wearing one. Return to shore immediately and disembark. Reduce the risk of sinking by ensuring the bilge system is functioning properly.

Ballast System

Axis's hard tank ballast system is the best, most discrete way to add significant weight or balance out your load to create the exact wake or wave you desire.

Hard tanks do not collect mildew on the outside and add to the maintenance requirements. Because the tanks are housed under the floorboard, storage is not compromised. (In Axis boats, the bow ballast only is an optional soft bag.)



All Axis boats are equipped with at least three ballast tanks and have an optional bow bag, plus optional plumbing for Plug 'n Play.

Most of the ballast system is invisible to the consumer, but its effects are obvious and enjoyable. The tanks are located beneath the deck in locations that will assist in balancing and enhancing the wake.

NOTICE

Optional plumbing for Plug 'n Play bags is available at the time of the original boat order. Axis recommends choosing bags from an Axis-approved ballast bag list for the corresponding model year (dealers have a list available). When bags from the approved list are used the bag weight does not need to be subtracted from the total boat capacity as that is already included. However, if bags are used that are not on the approved list, weight must be subtracted from the total allowable weight capacity for the boat. Weight distribution must also be considered. Exceeding the weight limits can lead to damage to the boat and contribute to more serious issues.

The tanks are filled and emptied by pumps that are controlled by buttons on the dash. See the *Dashes and Video Screens* section of this manual for more details.

Be sure to empty the ballast tanks prior loading the boat onto the trailer and removing the boat from the water. Tanks **MUST** be empty prior to trailering the boat as the additional weight can cause damage to the trailer, tow vehicle and imbalance on the trailer that could affect safety or overload the trailer and cause damage that is not covered under warranty.

WARNING

Water in the ballast tanks should always be pumped out prior to removing the boat from the water. Never trailer the boat with water in the ballast tanks; residual water can cause an imbalance that alters the amount of weight on the trailer tongue. Without the proper weight percentage forward, the trailer tongue can become unstable and cause loss of control of the trailer and tow vehicle. Additionally, attempting to trailer your boat without the ballast tanks and/or bags emptied can overload the trailer and cause damage that is not covered under warranty.

When emptying the ballast tanks, watch the outlets on both sides of the boat and aft, depending on the model and number of outlets. If you are uncertain, check with your authorized Axis dealer for assistance in determining the bilge outlets from the ballast outlets. Ballast pumps will continue working as long as the controller is on. Therefore, operators must ensure that the pumping is turned off when the outlets show only a minute amount of water is coming out. Leaving the pumps on will result in pump damage.

If the boat is equipped with additional ballast bags, Axis recommends rechecking that the rear tanks are empty five (5) minutes after starting the drain process. This verifies that no extra water was left in the bags and has drained into the hard tanks.

Models: All models are equipped with ballast systems, per the customer's order. The optional plumbing for Plug 'n Play must be part of the original order.

CAUTION

All tanks must be emptied **BEFORE** the boat is loaded onto a trailer. It makes maneuvering much easier, plus it helps avoid damage to the trailer or the boat hull. Such damage is not covered under warranty.

NOTICE

Boats that are going to be stored for more than a couple of weeks or prepared for winter, must have all the water removed from the ballast tanks. Failure to do so can result in damage that is not covered under warranty.

NOTICE

Ballast pumps must be turned **OFF** after emptying the tanks. When only a drizzle of water is coming from the outlets, manually turn **OFF** the ballast pumps, via the video screen. Allowing the ballast pumps to continue operating when there is no water to be pumped will result in the internal components being permanently damaged, which is not covered under warranty.



Flushing the Ballast Tank System

These procedures have been developed to help prevent the spread of aquatic invasive species, especially quagga and zebra mussels that attach and infest inside ski boat ballast tank systems. Flushing the system with hot water (120°F or greater) kill quagga and zebra mussel juveniles and larvae in seconds and protects water bodies from the many destructive invasive species that hitchhike on trailered watercraft. Finally, it enables boaters to comply with state and federal laws prohibiting the spread of quagga and zebra mussels. Failure to comply could result in the boat being impounded and the owner could be subject to criminal prosecution.

In general, when a water body is known to be infested with invasive species:

- Boats entering the water are not required to be inspected and cleaned.
- Boaters leaving the water should have their craft inspected, cleaned, and flushed according to these procedures (for ballast systems) and state/federal laws (for all boat and trailer requirements).

When a water body is known to **NOT** be infested with invasive species:

- Arriving boaters should be inspected according to state/federal laws (for all boat and trailer requirements) and these procedures (for ballast systems) before entering the water. If **ANY** mussel adults, juveniles or larvae are discovered, a complete cleaning of all equipment is required.
- Boats leaving the water are not required to be inspected and cleaned.
- Be sure to check state and federal laws and regulations to be sure you are complying with requirements when entering or exiting bodies of water known to be infested with invasive species.
- Locate the thru-hull ports on the starboard and port sides of the boat upon arrival to the designated inspection/wash station. See Figures 1 and 2 below for thru-hull port locations:

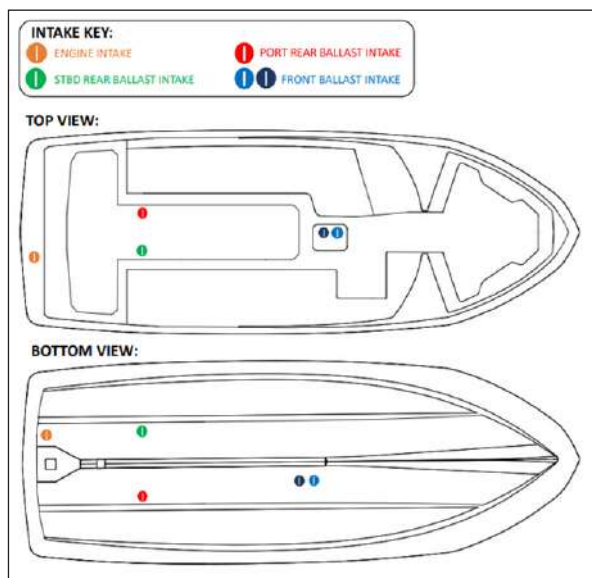

Figure 1: Intake Diagram

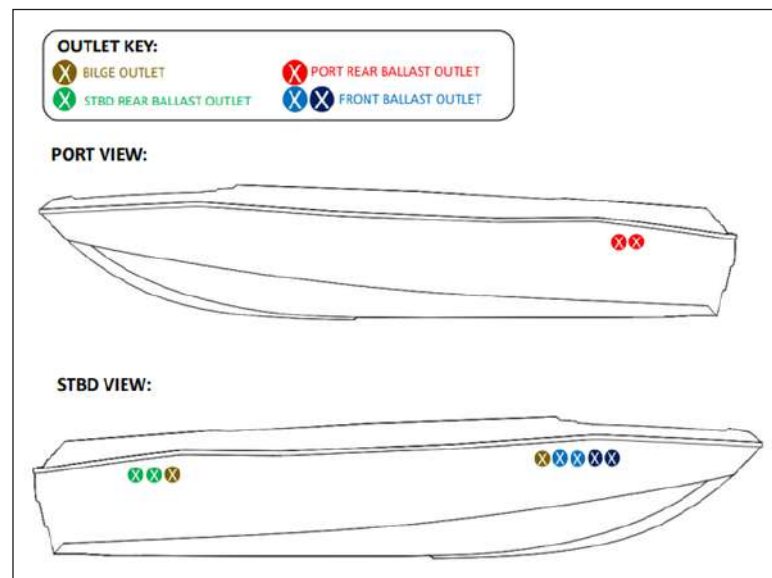

Figure 2: Outlet Diagram

- Fill each of these four (4) ports with hot water of at least 120°F.
- The corresponding ballast tank will completely fill with hot water and begin flowing out of the adjacent port and/or the port located on the bottom of the boat.
- Allow the hot water to continually flow for 10-15 seconds before moving to the next port.
- After all four (4) locations have been successfully flushed for 10-15 seconds, the process is complete.

Auto-Set Wedge

The Auto-Set Wedge allows the driver to displace water in addition to the ballast system. The Auto-Set Wedge is teamed with Surf Gate to maximize the wake experience. Because the water displacement affects how the boat handles, Axis recommends practicing operations with the Auto-Set Wedge and/or Surf Gate before deploying with riders/boarders/surfers behind the boat. If the Auto-Set Wedge fails to deploy or retract as designed, there may be damage to the Wedge system. Have your authorized Axis dealer evaluate the system for proper operation.



The Auto-Set Wedge is raised or lowered by opening the piehole access on the swim platform. Below the platform, a slide on the metal bar allows the Wedge support to move up and down. When the Wedge is lowered, the force of the water will hold it in place. To raise it, simply pull the wedge back into the upright position. When the Wedge is back into its upright position, the slides will lock it in place.

Note that the Auto-Set Wedge should always be retracted when not in use.

NOTICE

Never stand or sit on the Auto-Set Wedge plate or place objects on it. Never use the Auto-Set Wedge to mount the transom. The Auto-Set Wedge cannot sustain added weight on it, and subsequent damage to the Auto-Set Wedge or transom of the boat as a result will not be covered under warranty. Do not boat in shallow water, load the boat on the trailer or tow with the Wedge in the lowered position as it can cause damage to the Wedge that is not covered under warranty.

Models: (Optional) All models.

Power Wedge III

The Power Wedge III has up to 1,500 pounds of wake-creating water displacement. The upward angle radically increases lift, allowing the driver to get a fully loaded boat on plane much more quickly. The Power Wedge III is teamed with Surf Gate to maximize the wake experience.

The Power Wedge III is controlled through buttons on the dash and the touch screen display as explained in the *Dashes and Video Screens* section of this manual. The Power Wedge can also be controlled by the optional Surf Band. Because the water displacement affects how the boat handles, Axis recommends practicing operations with the Power Wedge III and/or Surf Gate before deploying with riders/boarders/surfers behind the boat.

The Power Wedge will not return to the Stow position unless the boat speed is above one (1) mph and below ten (10) mph. Always verify there is no person or object around the Power Wedge while it is stowing. If an object is obstructing the process, damage or injury could occur if caught between the wedge and the transom. The Power Wedge III has a pressure relief valve to allow the wedge to move manually and freely in the event of a fault. Information on how to use the pressure relief valve is provided in the *Care and Maintenance* section of this manual.

Note that the Power Wedge III should always be retracted when not in use.

NOTICE

Never stand or sit on the Power Wedge plate or place objects on it. Never use the Power Wedge to mount the transom. The Power Wedge cannot sustain added weight on it, and subsequent damage to the Power Wedge or transom of the boat as a result will not be covered under warranty. Do not boat in shallow water, load the boat on the trailer or tow with the Power Wedge in the lowered position as it can cause damage to the Power Wedge that is not covered under warranty.

Models: (Optional) All models.

Surf Gate®

Surf Gate, especially when teamed with the Power Wedge III, offers the most innovative wake production in the industry. As with the Power Wedge III, control of the two transom-mounted gates is through dash buttons as explained in the *Dashes and Video Screens* section of this manual. The Surf Gates can also be controlled by the optional Surf Band.

The gates are controlled by selecting the desired surf side of the boat (port/left or starboard/right). When a gate is deployed, the actual desired surf wake will be created on the opposite side of the boat. For example,



when the left wake is desired, select the left arrow; the right/starboard gate will be the gate that will deploy. The gate will deploy only between the speeds of nine (9) mph and fifteen (15) mph. If a Surf Transfer is initiated, there is a tone played through the tower speakers that signals to boarders/surfers when the surf wake is about to transfer from one side to the other. This will only happen if tower speakers are equipped, and the stereo is powered on. There is also an indicator light, offered with the optional tower light package, that will also indicate the surf wake is transferring. This can be deactivated as explained in the *Dashes and Video Screens* section of this manual.

Never place objects on a Surf Gate or try to use a gate to support a person's weight. The Surf Gates are not manufactured or mounted to accept additional weight.

The Surf Gates should always be retracted when not in use.



Always pay attention to how the weight is distributed in the boat, particularly when engaged in water sports. Too much ballast, gate, and passengers to one side of the boat could create an unstable condition that could create an unsafe situation for all. Even in making waves, care must be taken to put safe operation first.

NOTICE

Never add any weight to a Surf Gate, nor use one to hold a person's weight. The Surf Gate cannot sustain added weight on it, and subsequent damage to the Surf Gate or transom of the boat as a result will not be covered under warranty.

Models: (Optional) All models.

UNDERWATER GEAR

Beneath the boat are several critical components for the proper and safe operation of the boat. In general, consumers do not have to give these items attention beyond routine checks and maintenance, but if any of them are damaged, it can result in a truncated outing.

Rudder

The rudder is part of the steering system. The steering wheel turns the rudder in the direction that the driver wishes to steer. More information about the steering system is available in the *Starting and Operation* section of *Get Ready* in this manual. Note that the rudder extends below the hull of the boat. This is critical to remember when boating in shallow water or water with obstructions. Even if the water appears deep enough for the hull, it may not be deep enough for the rudder to pass unimpeded.

NOTICE

Do not operate the boat in water too shallow for the rudder to operate. Obstructions can also damage the rudder, rendering it inoperable. Such damage is not covered under warranty.

Fins

The fins add tracking stability. As with the rudder, they extend below the hull and should be considered when boating in shallow water.

Struts and Strut Housing

The strut and strut housing are fitted from the drivetrain to the propeller to create the propulsion that moves the boat forward and aft. As with the rudder, these components extend below the hull. Operation in water that is too shallow or among obstructions can damage the components and make it impossible to continue boating.

NOTICE

Do not operate the boat in water too shallow for the strut, strut housing, and propeller to operate. Obstructions can also damage these components, rendering them inoperable. Such damage is not covered under warranty.



Propeller

Different conditions, including altitude or specific characteristics of individual bodies of water can impact boating enjoyment. If environmental conditions are suspected of negatively impacting performance, discuss this with an authorized Axis dealer, who may be able to recommend minor changes to the propeller, or replacement of a propeller at the consumer's choice and expense, that will improve circumstances for that application. There are limits to changes that are approved by Axis engineers. Changes that exceed those standards will void the warranty. Extreme changes can also alter the safe handling of the boat and its maneuverability.

DANGER

Care must be taken to avoid being in the water forward or aft of the boat when the engine is running, even if the boat is not in a moving gear. If the shifter/throttle goes into gear, there may not be time for people to get out of the way. Propeller edges are sharp. With motion, propellers can maim or become lethal.

NOTICE

Consumers may choose to change characteristics of propellers or even replace them. Axis recommends doing so only after consulting with an authorized Axis dealer as exceeding Axis standards for the propulsion system will void the warranty.

Never allow anyone to be in the water forward of the bow or behind the boat when the boat engine is running, even if the boat is in neutral gear. If the shifter/throttle is inadvertently put into gear, the boat could potentially run over persons in the water. A moving propeller is extremely dangerous and could cause serious injury or death.

Raw Water Intake / Sea Strainer

The raw water intake brings water out of the body of water for cooling circulation in the engine. It is circulated and returned to the body of water via the exhaust system.

The raw water intake/sea strainer must always be free of debris. Any boating that takes place in brackish water or water with flora, should be interrupted periodically to be certain that no weeds have become tangled with anything under the hull. See the *Care and Maintenance* section in this manual for information on how to properly remove debris from the raw water intake/sea strainer.



NOTICE

Debris in the body of water, including naturally occurring vegetation, can become entwined with the components under the hull. This can result in damage to the boat, particularly if the debris interferes with the raw water intake, starving the drivetrain of necessary cooling water. Such damage is not covered under warranty.

Flush Kit

The flush kit is standard on all boats and is used to clean out the raw water pickup and operational areas of the engine. The kit attachment is located on the port side of the transom.

Before every outing, inspect the flush kit cap to ensure that it is tight. If the cap is not tight, it will inhale air, which could damage the cooling system. Such damage is not covered under warranty.

See Flush Kit information in the *Care and Maintenance* section of this owner's manual for more information on how to use this feature.



 **DANGER**

Avoid running the boat's engine, if possible, while anyone is on the swim board or sun pad. Exhaust fumes are emitted from beneath the swim platform and the odorless, colorless carbon monoxide can sicken or kill before individuals are aware there is danger. If water for the shower needs to be heated, run the boat engine as briefly as possible, and shower quickly. NEVER shower for lengthy periods of time as one might onshore. Move away from the swim board and/or sun pad as soon as the shower is turned off and stowed, to allow time for the fumes to dissipate.

NOTICE

The flush kit switch should ALWAYS be in the OFF position when there is no water in the tank. Allowing the pump to run without water can result in damage to the system, which is not covered under warranty.

NOTICE

Ensure the flush kit cap is secure prior to every outing. If it is not, air can be introduced into the cooling system, resulting in damage that is not covered under warranty.

Swim Board

The swim board provides additional enjoyment of the Axis experience. While the swim board can ease movement in and out of the water, Axis reminds users to exercise caution. When jumping off the boat, always be certain that there is sufficient depth. Appearances can be deceptive, especially in clear water.

Although the swim board is constructed with anti-skid properties, it is still the responsibility of users to use care when walking on it, using it to get on board, using it to get into the cockpit, standing or sitting on the swim board.

As noted multiple times throughout this manual, never allow anyone to be on the swim board when the engine is running, due to exhaust fumes.

Models: All Axis boats are equipped with a swim board.

 **DANGER**

Never allow anyone to be on the swim board when the engine is running, even at idle. Exhaust fumes can quickly overcome individuals, leading to serious injury or death. More information is available in the Safety section of this manual.

SALTWATER SERIES

IMPORTANT: Review the information that appears in the Care and Maintenance section of this manual for specifics regarding the proper maintenance to reduce and retard corrosion damage to boats operated in salt or brackish water.

The Saltwater Series is a package available that ensures the appropriate options for salt/brackish operation are met in a single package rather than having to order these components separately.

Boats that will be operated in saltwater—or brackish fresh water—require several alterations to ensure that they will continue to operate properly. While care and maintenance are critical for all boats, those that are run in saltwater require even more attention to detail.

Salt or polluted fresh water can quickly damage the boat, including corrosion that may result in a serious threat to the well-being of boaters.

 **WARNING**

Boats that have been operated in polluted fresh water or salt water should be thoroughly rinsed with clean, fresh water after an outing. The corrosive properties of saltwater can cause damage that is not covered under warranty. Hardware that is damaged by brackish or salt water can eventually fail, which could cause malfunction of the hardware, even hardware chosen for its anti-corrosive properties, and/or the components that are held in place by the hardware, which could result in serious injury or death to persons onboard.



Among the components that are changed or adjusted for operation in salt water during construction are:

- stainless steel gas shocks;
- grounding and bonding of all components below waterline;
- the addition of sacrificial zinc anodes.



One of the most important saltwater components is the sacrificial zinc anodes. These are attached to the exterior of the boat, below the water line.

The purpose of an anode is to be sacrificial. There is a greater degree of attraction between the anode's metal and the corrosive action of the saltwater than between the boat's metal parts and the water. In the most simplistic terms, both rust (oxidation) and metal reduction are the effects of operating in saltwater. To reduce these naturally occurring results on boat components, the sacrificial anodes attract and reduce most of the effects.

Important Note: The sacrificial zinc anode does not eliminate the corrosion process. Therefore, it is important to flush and rinse the boat after use.

As part of the routine maintenance, regularly check the anodes, which are located on the transom, driveshaft, and rudder, where equipped. Verify with your authorized Axis dealer the appropriate reduction at which it is time to replace the anode.

Models: (Optional) All models.

NOTICE

Reduction of the sacrificial zinc anode because of operation in brackish fresh water or salt water conditions is normal as it protects to some degree the rest of the boat. Replacement of the anode is considered part of the routine maintenance procedure and is not covered under warranty.



Reporting Safety Defects

If you believe that your vehicle has a defect which could cause a crash or could cause injury or death, you should immediately inform the National Highway Traffic Safety Administration (NHTSA) in addition to notifying Malibu Boats, LLC, parent company of Axis Trailers.

If NHTSA receives similar complaints, it may open an investigation, and if it finds that a safety defect exists in a group of vehicles, it may order a recall and remedy campaign. However, NHTSA cannot become involved in individual problems between you, your dealer, or Malibu Boats, LLC.

To contact NHTSA, you may call the vehicle Safety Hotline toll-free at 1-888-327-4236 (TTY:1-800-424-9153); go to <http://nhtsa.safercar.gov>; or write to: Administrator, NHTSA, 1200 New Jersey Avenue SE, Washington, DC 20590. You can also obtain other information about motor vehicle safety from <http://www.safercar.gov>.

AXIS TRAILERS

Legal Requirements for Towing

Be aware that many state and local jurisdictions in North America have specific laws and/or ordinances regarding towing. It is the operator's responsibility to research and become familiar with specific requirements that are in effect in the areas in which you will be towing. Information is often available online, but you can also contact your area's motor vehicle office for direction and details.

If you will be taking your boat and trailer on vacation or to an outing in another jurisdiction in which you do not regularly tow, it is necessary to determine the appropriate laws for that area. Law enforcement officers will expect you to have knowledge of applicable laws and ordinances. Laws can cover, but are not limited to, such components and matters as lights, brakes, safety cables, driver's license requirements, trailer licenses and permits, and overall size. Some areas may also have insurance requirements. Determine whether you must carry liability insurance specifically for towing. If you have financed your boat and/or trailer, your lender may also require full coverage. This is also your responsibility to determine and to secure as needed. Axis Trailers does not assume any responsibility for your knowledge and confirmation that the requirements have been met.

Basic Safety Rules

Make sure you understand all of the operating instructions prior to attempting to operate this trailer. Accidents are generally caused by the operator's failure to follow basic safety rules or written precautions. Most accidents can be avoided if the operator is completely familiar with the trailer and its operation, follows recommended practices, and is able to recognize and avoid potentially hazardous situations.

Failure to observe the safety recommendations contained in this manual may result in severe personal injury or death to you or to others. Use caution and common sense when trailering. Don't take unnecessary chances! Some basic safety rules are outlined in this section of the manual.

Axis strongly encourages people towing to read all safety material available (including non-owners of trailers who will be towing the trailers), and to become familiar with laws and ordinances pertaining to towing and driving within applicable jurisdictions. It is advisable to also pay attention to insurance requirements and to fully insure the trailer and boat to be prepared for any potential liability. Review the tow vehicle's owner's manual as well, prior to operation and towing.



CONNECTION TO THE TOW VEHICLE

Preparation



The Gross Vehicle Weight Rating (GVWR) is the total estimated weight that a road vehicle loaded to capacity (including the vehicle weight itself) can be expected to tow safely. This includes the trailer, boat engine, any liquids including fuel, and items carried on and in the tow vehicle and the boat. This is a maximum established by federal mandate and enforced by law enforcement authorities. Overloaded capacity can cause the trailer to disengage from the hitch, which could result in serious injury or death, in addition to damage that is not covered under warranty.

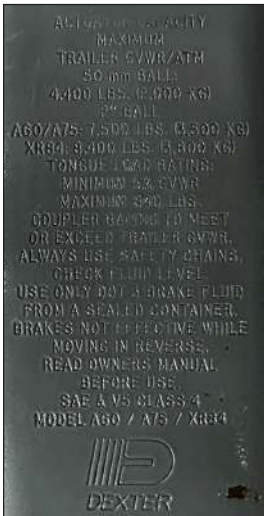

Never tow the trailer and contents, including the boat, behind a vehicle that is not rated to tow this weight. Also, be certain that the tow hitch is correct. Additional information follows regarding this important factor.

On the left front side of the trailer is a certification label that shows the maximum load-carrying capacity of the trailer. The GVWR will be indicated on this label.

Many truck stops offer complimentary weigh scales. If you are not able to locate scales, nor compute the total GVWR from the individual components being towed, contact your DMV for assistance in finding scales in your area.



Remove wakeboards and skis from above the boat deck (i.e., from the tower). Even with careful attachment to the racks, these paraphernalia can disconnect and become projectiles that threaten other vehicles following.



Never tow with water in the ballast or bilge systems! All water must be released prior to loading the boat on the trailer. Water onboard can cause an imbalance on the trailer that further heightens the likelihood of an accident due to loss of control when there is insufficient percentage of weight at the tongue and hitch.

Trailer Hitch

A **weight-carrying hitch** should be used for towing an Axis trailer. No other hitch type meets the requirements for safely operating the trailer. The tow vehicle may have requirements regarding an acceptable hitch, so verify by reading the tow vehicle's owner's manual for direction. A **weight-distributing hitch** can be used, particularly in an emergency, but if the trailing arms are used, the Axis trailer's brakes will not operate.

Hitch up with the trailer in a level position to the tow vehicle. Note that attempting to tow with a trailer that is not level across the length of the trailer could either cause the brakes to prematurely activate or not activate at all, potentially causing a loss of control.

If the hitch height is incorrect and does not allow the trailer to be level, it may be necessary to install air-pressure adjustable shock absorbers on the tow vehicle. If a weight-distributing hitch is installed, change out to a weight-carrying hitch instead. Or consult with the tow vehicle manufacturer's authorized dealer for other assistance.

In general, for Class 4 rigs, (5,000-10,000 lbs.) a ball of 2" or 2-5/16" is required.



Safety Cables

The safety cables can prevent a trailer from totally disengaging from the hitch. If it becomes necessary in the future to replace the cables, ensure that the replacement cables meet the Society of Automotive Engineers (SAE) J684 standard for trailer hitching and coupling. The cables must match or exceed the trailer's GVWR.

Cables must be as centrally attached as possible to the bumper or frame of the tow vehicle. The hitch should provide a location through which the safety cables can be attached. Holes or rings should be on both sides of the hitch ball.

Most states require that the safety cables should be crisscrossed under the trailer tongue prior to being attached to the other hole or ring location. If the trailer disengages, these cables should prevent the trailer tongue from falling onto the tow surface.

The cables should be attached as tautly as possible but still allow for turning, including close quarters turns.

The trailer also is equipped with a surge brake breakaway cable. This cable, explained further in this section of the Owner's Manual, must also be attached to the tow vehicle frame, securely but allowing for turns.

A truck or van with a step bumper requires an eyebolt or equivalent safety cable attachment, which meets the Society of Automotive Engineers: SAE J684 Standard. Refer to the tow vehicle's owner's manual for additional details. This is critical as some tow vehicle's safety cable attachments may be too small.



Safety cables and the breakaway cable must be securely attached to the tow vehicle, while allowing for turns. Failure to do so could result in serious injury or death, as well as property damage to other persons and vehicles on the road if the trailer becomes disengaged from the tow vehicle.

Breakaway Cable

If the cable clip is missing, or it has been broken by the cable being pulled, first check and attempt to release the emergency brake mechanism by pressing up on the brake release tab under the actuator nose, right behind the tow ball insert location. Press up on the brake release tab, and if a metallic clunk or sound of a spring releasing is heard, that means the emergency brake mechanism had previously been engaged. When pressing up on the brake release tab, if it moves up and down freely with just the resistance of its spring, then the emergency brake system was likely not previously engaged.

Be sure the emergency brake mechanism is not engaged prior to towing. If the cable was pulled hard enough to break the clip on the cable, the cable and clip must be replaced, and the actuator checked for proper function. Your authorized Axis dealer can obtain a cable replacement kit that is specific to the actuator model used on your trailer.



Weight Distribution

A range between 5 to 10 percent (5%-to-10%) of the total weight on the trailer must rest at the coupling ball when the tongue is parallel to the ground. This determination can be made with a bathroom scale, provided you know the total weight of the trailer, boat, and items onboard.

Some vehicle manufacturers limit tongue weight to a maximum of two hundred pounds when using certain types of weight-carrying, bumper-mounted hitches. Check the tow vehicle's owner's manual to determine the correct distribution.



Failure to properly distribute weight in the boat and across the trailer can result in the trailer fishtailing (swaying from side-to-side) in a dangerous fashion that puts not only the total rig at risk but also other vehicles and persons on the road. Adequate download on the hitch ball is critical!



HOW TO CONNECT TO THE TOW VEHICLE

Attaching to the Tow Vehicle

- Open the coupler mechanism (Instructions below)
- If necessary, use the trailer jack to have the trailer at the proper height, which is just above the height of the ball on the tow vehicle.
- Hitch **ONLY** to a ball that is sized properly for the coupler.
- Back up the tow vehicle **SLOWLY** to the trailer. Many tow vehicles now have a backup camera that makes this process easier, but it will still require practice. If you do not have a backup camera, having a second person to offer hand signals can be helpful.

WARNING

When using a second person to assist in the backing up process to hitch the trailer to the tow vehicle, always watch in your mirror. Do not allow the person to stand between the tow vehicle and the trailer as they can be struck by the vehicle or caught between the tow vehicle and the trailer. Such activity requires common sense and care to avoid injury.

NOTICE

Never move the trailer toward the tow vehicle. When the trailer is not fully hitched up, the brakes are not operational.

- Release the coupler latch. The hitch pin should fit easily into the hole. If it does not, this means that the latch is not completely closed. It will not close unless the coupler fits snugly over a properly sized ball. If the hitch pin is damaged or lost, it must be replaced prior to operating the rig.

WARNING

The hitch pin must be properly installed and secure prior to operation. If it is damaged or missing, you can operate temporarily with a 1/4" or 5/16" shank padlock. Never operate without the hitch pin or padlock as the trailer and contents can become disengaged from the tow vehicle, which may result in an accident or damage that causes serious injury or death.

To Open the Coupler

- Remove the hitch pin from the hole in the side of the coupler.
- While holding the button, raise the handle.

To Close the Coupler

- Place the coupler over the ball.
- Lower the coupler.
- Close the handle. An audible sound will be heard. If the handle does not close easily, the ball is not fully within the socket. **DO NOT FORCE** the handle to close as it is likely that the ball is the wrong size and should be replaced.



WARNING

Never tow with the coupler handle open or partially open. If the handle will not remain closed, go back through the steps to ensure that it will close and stay closed. If you are unable to get the system to perform correctly, see an authorized Axis dealer for assistance. Failure to get the coupler secure could result in the trailer disengaging, which could lead to serious injury or even death.

CAUTION

Axis trailers require a seven-pin connector. Some older tow vehicles may have a five-pin connector instead of a seven-pin connector. An adapter is available through the tow vehicle's manufacturer. This is required to allow the back-up lights and solenoid to operate correctly. Failure to ensure that the entire lighting system on the trailer is operating correctly can mean that other vehicles following or in the vicinity of your tow equipment may not be alerted when you shift into reverse. This could lead to vehicle damage or injury.



NOTICE

As part of the hitching-up process, late model tow vehicles are usually equipped with a sensor that reports when the trailer lights have been connected to the tow vehicle's connector. However, the LED light utilized on Axis trailers sometimes does not pull a sufficient load on the tow vehicle's electrical system to register. This situation can be simply remedied by the tow-vehicle's dealership.

Unhitching

The coupler should easily unlatch, but if it does not, check to see if the ball is correctly sized, or if the trailer is parked on a hill, which will inhibit the ability to successfully open the coupler.

Hitching

- After securing the coupler to the hitch ball, double-check that the hitch pin is properly installed, and the coupler handle secure.
- Cross the safety cables under the coupling, allowing only enough slack to enable turning when the rig is in operation.
- Attach the breakaway cable to the tow vehicle.
- Connect the trailer's seven-wire connector to the seven-wire connector of the tow vehicle and check that the lights are working correctly. (See "Trailer Components and How They Function" section for additional information).

CONNECTING TO THE BOAT

Trailer Winch

The trailer winch is a manually operated device to assist loading the boat onto the trailer and maintaining it in position for proper towing. The following information is important in assuring control and protection for you and the boat:

- **Inspect the winch prior to every use.** Never use the winch if there is any sign of damage. Your authorized Axis Trailer dealer can assist you in repairs.
- **Firmly grip and hold on to the winch handle when the handle is not locked!** Letting go can cause the handle to spin wildly out of control if there is tension on the line. Lock the ratchet lever on the winch any time you will not be using it to load or unload the boat.



WARNING

Failure to lock the ratchet lever on the winch when the boat is being loaded or unloaded or when there is tension on the line, can result in loss of control, with the handle spinning. This could result in serious injury. Also, the boat could slip off the trailer, causing damage that is not covered under warranty.

- **The winch will have a rated capacity, which must not be exceeded.** This includes the weight of all items onboard. Water in the ballast and bilge systems should be released prior to loading to avoid exceeding weight limits.
- The winch should not be fully extended prior to loading. To operate properly, leave at least a couple of turns of strap on the winch.
- **The boat should be partially loaded on the partially submerged trailer by engine power.** More on this technique is explained later in this section. Using the winch as the sole method for loading puts undue strain on the winch strap and results in excessive wear.
- **Check the straps prior to each loading.** The straps will wear with age, use, and exposure to the elements. Because of the importance in holding the boat secure for loading, unloading, and towing, never use worn straps. Replace with Axis-approved straps only.
- **As part of the maintenance program, the gears should be greased with a heavy-duty, marine-grade grease regularly.** This allows for continued proper operation and will help in the ease of operating the handle as well.
- **Attach the winch to the bow eye on the boat for loading.** The winch should never be attached to any other component of the boat.
- **Do not rely on the winch to be the only manner in which the boat is held on the trailer.** Use all other tie-downs as described in this section. The winch is insufficient to hold the boat in place.





WARNING

Attaching the winch to any component of the boat other than the bow eye, and attempting to load the boat, can result in damage to the boat, which may result in serious injury or death. This is not covered under warranty.

Tie-Downs

As part of the security for towing, the boat is equipped with tie-downs fore and aft on the boat and optionally on the trailer. Seek assistance from an authorized Axis Trailer dealer to determine the location on your boat model and trailer as they vary by model. Also seek instruction for the proper way in which to tie or hitch the lines for both a secured boat and ease of unlatching the hitches when you arrive at your destination.



TRAILER COMPONENTS AND HOW THEY FUNCTION



Trailer Jack

The trailer is equipped with a trailer jack, which serves several purposes. (Larger Axis models come equipped with a heavy-duty jack.)

The trailer jack can hold and lift the trailer to position for lowering on the hitch ball of the tow vehicle. It is also useful for assisting and balancing as a trailer rests free of the tow vehicle or is moved. Axis trailers are also equipped with a level on the frame behind the jack to assist with ensuring the boat can be towed levelly.

Rotate the trailer jack so that it is vertical and snap the locking pin before placing any kind of load on the trailer jack. Always retract and rotate back into the horizontal position for stowing or towing.



WARNING

Also snap the locking pin on the trailer jack prior to placing any kind of load on the jack. Failure to do so could result in the trailer jack collapsing or otherwise failing, which could lead to serious injury or death.

NOTICE

Failure to properly stow the trailer jack in a horizontal position, and lock in place, could result in damage to the jack or other trailer components that is not covered under warranty.

The drive gear and rack-and-pinion that control the trailer jack movement should be periodically greased with a marine-grade grease. The wheel bearings in the jack and the coaster should also be periodically oiled to ensure that the components continue to operate as designed.

Removable Guide Poles

Axis trailers are equipped with removable guide poles as standard equipment. The poles, located on each side of the trailer, assist in assessing the total width of the boat and trailer relative to towing or while backing up, as well as parking the trailer and boat inside/under shelter such as a garage.

Please note that, depending upon the state or jurisdiction in which the trailer is being towed, the guide poles may need to be removed while the trailer is in transit. **It is the responsibility of the tow vehicle owner/operator to determine whether the total width of the trailer at the guide poles exceeds the legal limits and remove the guide poles where necessary.**

The poles are held in place on the trailer with quick release pins. When the guide poles are removed, the poles and pins must be stored in a clean,



dry location. This could be the bed of the tow vehicle, and some storage locations in the boat may be large enough to store them. Regardless of the solution, the poles and pins should be kept where they can be accessible as needed.

Lights



NEVER operate the trailer, even during daylight, without verifying that the lights work properly. When the brakes are applied, it is critical that traffic following can see that you are slowing and/or stopping by seeing the brake lights come on. In the event of rain, running lights are required in most locations to tow the trailer. Even assuming you will return prior to dark, events could occur that result in towing after dark.

Axis trailers will integrate with most tow vehicle wiring harness requirements. If the harness will not connect to the plug, contact either the authorized Axis Trailer dealer for assistance or the tow vehicle's authorized dealer. A different harness or an adapter may be necessary. These should be installed only by trained service technicians. Never use any harness or adapter that is not specified by the tow vehicle manufacturer and Axis Trailers.



As part of the hitching process, late-model tow vehicles are usually equipped with a sensor that reports when the trailer lights have been connected to the tow vehicle's connector. However, the LED lights utilized on Axis trailers sometimes do not pull a sufficient load on the tow vehicle's electrical system to register. This situation can be remedied by the tow vehicle's dealership.



Axis trailers require a seven-pin connector. Some older tow vehicles may have a five-pin connector instead of a seven-pin connector. An adapter is available through the tow vehicle's manufacturer. This is required to allow the back-up lights and solenoid to operate correctly. Failure to ensure that the entire lighting system on the trailer is operating correctly can mean that other vehicles following or in the vicinity of your tow equipment may not be alerted when you shift into reverse. This could lead to vehicle damage or injury.

The trailer is equipped with running lights as well as taillights, stoplights, and optional landing lights. As specified by Axis, the lights have a very long lifetime, but if any ever cease to work, take the trailer to the nearest authorized Axis Trailer dealer to have the light repaired. If the exterior lens cover is damaged or broken, the entire one-piece unit will need to be replaced.

Additionally, these tips can help keep the light system working at its best:

- Check for properly operating lights prior to each use.
- Be sure the ground wire (white) at the tongue is properly connected to the harness at all times.

If your trailer is equipped with the optional landing lights, be sure that the landing lights are off when operating the trailer on highways and public roads. In some jurisdictions, operation of the landing lights over the road is illegal.



Axles

The trailer is equipped with the VAULT™ bearing protector. The VAULT uses only UFP Hybrid Oil™ lubricant, which combines the benefits of oil and grease. The VAULT protects the wheel bearings in a sealed, pressurized chamber that is unaffected by outside elements. For optimal performance, only UFP's Hybrid Oil lubricant should be used in this system.

The system has several unique features not found on conventional trailer axles. Every possible leak point on the front and rear of the hub is sealed. (The slight pressure inside the hub is needed to keep water



out of the hub chamber when the hub is submerged underwater during loading and unloading).

Inspection or replenishment of the lubricant is not required as part of the routine maintenance for the first five (5) years.

NOTICE

Adding or changing the lubricant in the VAULT system is neither necessary nor recommended during the first five (5) years of service. After that time, the maintenance requirements should be undertaken only by an authorized Axis dealer and only the UFP's Hybrid Oil Lubricant should be used.

If the bearings need to be adjusted or replaced, the work should be done only by an authorized Axis Trailer dealer.

Failure to contact Axis for preapproval during the warranty period will void the warranty.

The wheel bearings have been precisely torqued at the factory. To assure the bearings are in good working order, check the bearing adjustment at least once a year by following this procedure:

- Jack up on one side of the trailer. (Be certain to use jack stands and chock the trailer wheels to keep the trailer from moving during the inspection.)
- Grip the edge of the tire and see if it can be rocked or moved.
- If the outer edge of the tire moves more than 1/8", the bearings may need to be readjusted.
- A slight amount of oil seepage at the rear seal is normal and necessary to lubricate the wiper lip of the seal for long life. If excessive leakage is occurring, however, contact an authorized Axis trailer dealer.

Wheels and Hubs

Because the wheels and hubs will be submerged in water at times, they require more attention than those found on a tow vehicle. Wheels should be regularly washed with mild soap or detergent to retain the finish and remove any corrosive elements. Never use harsh detergent or scrub brushes that can damage the appearance.

If your boat is stored in an area that experiences snow or ice, Axis highly recommends periodically checking and cleaning your wheels during the winter. Even following inclement winter weather, salt and chemical treatments used to remove snow and ice from roads and parking lots can settle on the wheels and cause damage to the finish.

Such damage is not covered under warranty.



Lug Nuts

Prior to each outing, check that the lug nuts have retained the correct torque. It is critical to use the correctly sized wrench when tightening or loosening lug nuts. (At present, Axis is using 3/4" lug nuts on all trailers.) The wrong size wrench can cause the lug nuts to become rounded off, which can make them impossible to use.

Never tow a trailer with a missing lug nut or lug nuts. Having the complete number of lug nuts, properly torqued, is critical for both long-term use of the product and for road safety. *Even one fewer lug nut can apply stress to the remaining lug nuts and the hub, which could result in failure.*

Do not replace lug nuts, even missing ones, with lug nuts other than those available through an authorized Axis Trailer dealer. **The lug nut seat angle must match the wheel seat angle.** The assembly uses a specified lug nut selected for the kind of use the trailer will need. Even if the threads match, unapproved lug nuts may not hold the wheel securely enough. Lug nuts on each wheel should always match.

The torque applied when securing the lug nuts is also extremely important. If it is under-tightened, a lug nut can work loose under operation and come off. An over-tightened lug nut can strip the threads and come off.

! DANGER

Check the lug nut torque after the first fifty (50) miles of trailer use. **Then the lug nut torque should be checked every month afterwards that the trailer is used, and always checked prior to use if the trailer has been in storage or not used for a period of at least two weeks.** Failure to do so could result in lug nuts loosening or dislodging from the wheel assembly. Such activity can have catastrophic results, including loss of tow vehicle and/or trailer control, which could result in serious injury or death.



! DANGER

Lug nuts must also be correctly sized and specified for each trailer wheel. Failure to properly install and maintain the lug nuts could result in the trailer wheel coming off during operation. Such failure can result in serious injury or death, as well as property damage.

Follow these instructions for ensuring proper installation and torque for the lug nuts:

- Use a torque wrench. No other wrenches or similar tools are appropriate for use, except in an emergency.
- Keep a record of readings. If a lug nut or nuts routinely loses torque, it is symptomatic of a bigger problem that should be brought to the attention of your authorized Axis Trailer dealer to remedy.
- Use the pattern to the right to tighten lug nuts: On the first round, tighten to 45 ft. lbs. Tighten a second time to 70 ft. lbs. Tighten again to 90 ft. lbs. And on the final time, tighten to 120 ft. lbs. Do this in a star pattern; do not simply go around clockwise or counterclockwise. The cross effort will ensure a correct reading.

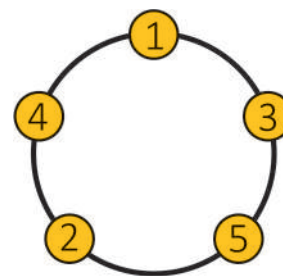

Tires

Always keep tires to the specified inflation. The tire manufacturers will indicate the proper air pressure on the sidewall of the tire; this information is also available on the tire manufacturer's website.

Be sure to have a spare tire on all outings. Even new tires can be damaged or lose air.

! WARNING

Follow the tire manufacturer's requirements to properly maintain tires. Failure to do so will cause tire failure while in use. This will result in loss of control of the trailer, which can lead to serious injury or death.

When storing the trailer, periodically check the tire inflation. Loss of inflation can signal a problem and can shorten the duration of the tire's life. Also shield tires from UV rays, which can significantly damage rubber. If it is possible to support the trailer frame during storage with jack stands or concrete blocks, this can help lengthen the life of the trailer's springs on trailers so equipped, as well as relieving pressure on the tires.

Although the tires selected for the Axis trailer are durable, eventually they will require replacement. **DO NOT** mix radial and bias-ply tires. This could affect handling and, ultimately, safety. **Be certain that the replacement tires meet the trailer requirements and integrate with the remaining tires.**

The following information provided about tires is presented courtesy of the National Highway Traffic Safety Administration (NHTSA). Reprinted by permission.

Tire Safety: Everything Runs On It

Studies of tire safety show that maintaining proper tire pressure, observing tire and vehicle load limits (not carrying more weight in your vehicle than your tires or vehicle can safely handle), avoiding road hazards, and inspecting tires for cuts, slashes, and other irregularities are the most important things you can do to avoid tire failure, such as tread separation or blowout and flat tires. These actions, along with other care and maintenance activities, can also:

- Improve vehicle handling.
- Help protect you and others from avoidable breakdowns and accidents.
- Improve fuel economy.
- Increase the life of your tires.

The following section presents a comprehensive overview of tire safety, including information on the following topics:

- Basic tire maintenance.
- Uniform Tire Quality Grading System.
- Fundamental characteristics of tires.
- Tire safety tips.

Use this information to make certain tire safety is a regular part of your vehicle maintenance routine. Recognize that the time you spend is minimal compared with the inconvenience and safety consequences of a flat tire or other tire failure.



Safety First — Basic Tire Maintenance

Properly maintained tires improve the steering, stopping, traction, and load-carrying capability of your vehicle. Underinflated tires and overloaded vehicles are a major cause of tire failure. Therefore, as mentioned above, to avoid flat tires and other types of tire failure, you should maintain proper tire pressure, observe tire and vehicle load limits, avoid road hazards, and regularly inspect your tires.

Finding Your Vehicle's Recommended Tire Pressure and Load Limits

Tire information placards and vehicle certification labels contain information on tires and load limits. These labels indicate the vehicle manufacturer's information including:

- Recommended tire size.
- Recommended tire inflation pressure.
- Gross Vehicle Weight Rating (GVWR—the maximum occupant and cargo weight a vehicle is designed to carry).
- The gross axle weight rating (GAWR—the maximum weight each axle is designed to carry).

Both placards and certification labels are affixed to the trailer. The recommended tire pressure is on the tire, and the tire pressure and load limit appear on the trailer label.

Understanding Tire Pressure and Load Limits

Tire inflation pressure is the level of air in the tire that provides it with load-carrying capacity and affects the overall performance of the trailer. The tire inflation pressure is a number that indicates the amount of air pressure—measured in pounds per square inch (PSI)—a tire requires to be properly inflated.

The proper tire pressure for the trailer is referred to as the “recommended cold inflation pressure.” As you will read below, it is difficult to obtain the recommended tire pressure if your tires are not cold.

Because tires are designed to be used on more than one type of vehicle, tire manufacturers list the “maximum permissible inflation pressure” on the tire sidewall. This number is the greatest amount of air pressure that should ever be put in the tire under normal driving conditions.

Checking Tire Pressure

It is important to check your trailer's tire pressure at least once a month or every 50 miles, whichever comes first, for the following reasons:

- Most tires may naturally lose air over time.
- Tires can lose air suddenly if you drive over a pothole or other object or if you strike the curb when parking.
- With radial tires, it is usually not possible to determine under-inflation by visual inspection.

For convenience, purchase a tire pressure gauge to keep in your tow vehicle. Gauges can be purchased at tire dealerships, auto supply stores, and other retail outlets.

The recommended tire inflation pressure that manufacturers provide reflects the proper psi when a tire is cold. The term “cold” does not relate to the outside temperature. Rather, a cold tire is one that has not been driven on for at least three (3) hours. When you drive, your tires get warmer, causing the air pressure within them to increase. Therefore, to get an accurate tire pressure reading, you must measure tire pressure when the tires are cold or compensate for the extra pressure in warm tires.

Steps for Maintaining Proper Tire Pressure

- Step 1: Locate the recommended tire pressure on the trailer label.
- Step 2: Record the tire pressure of all tires.
- Step 3: If the tire pressure is too high in any of the tires, slowly release air by gently pressing on the tire valve stem with the edge of your tire gauge until you get to the correct pressure.
- Step 4: If the tire pressure is too low, note the difference between the measured tire pressure and the correct tire pressure. These “missing” pounds of pressure are what you will need to add.
- Step 5: Add the missing pounds of air pressure to each tire that is under-inflated.
- Step 6: Check all the tires to make sure they have the same air pressure.



If you have been towing your trailer and think that a tire is under-inflated, fill it to the recommended cold inflation pressure indicated on your trailer label. While your tire may still be slightly under-inflated due to the extra pounds of pressure in the warm tire, it is safer to drive with air pressure that is slightly lower than the vehicle manufacturer's recommended cold inflation pressure than to drive with a significantly under-inflated tire. Since this is a temporary fix, don't forget to recheck and adjust the tire's pressure when you can obtain a cold reading.

Tire Size

To maintain tire safety, purchase new tires that are the same size as the trailer's original tires, or another size recommended by the manufacturer. At present, the trailer manufacturer is not recommending any size differential than was originally equipped. If you have any doubt about the correct size to choose, consult your authorized Axis Trailer dealer.

Tire Tread

The tire tread provides the gripping action and traction that prevent your vehicle from slipping or sliding, especially when the road is wet or icy in general. Tires are not safe and should be replaced when the tread is worn down to 1/16". Tires have built-in tread wear indicators that let you know when it is time to replace your tires. These indicators are raised sections spaced intermittently in the bottom of the tread grooves. When they appear even with the outside of the tread, it is time to replace your tires. Another method for checking tread depth is to place a penny in the tread with Lincoln's head upside down and facing you. If you can see the top of Lincoln's head, you are ready for new tires.

Tire Balance

To avoid vibration or shaking of the vehicle when a tire rotates, the tire must be properly balanced. This balance is achieved by positioning weights on the wheel to counterbalance heavy spots on the wheel and tire assembly.

Tire Rotation

Rotating tires from front to back and from side to side can reduce irregular wear (for vehicles that have tires that are all the same size). The generally recommended rotation period is every 5,000 miles.

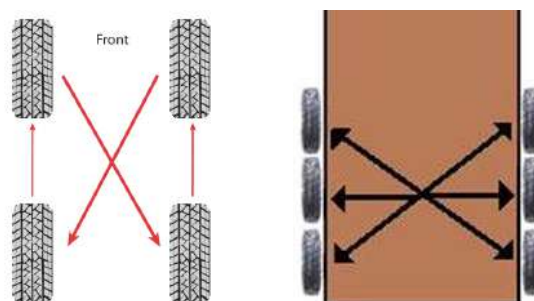

Uniform Tire Quality Grading System (UTQGS)

To help consumers compare tread wear rate, traction performance and temperature resistance, the federal government requires tire manufacturers to grade tires in these three areas. This grading system, known as the Uniform Tire Quality Grading System (UTQGS), provides guidelines for making relative comparisons when purchasing new tires. You also can use this information to inquire about the quality of tires placed on new vehicles.

Although this rating system is very helpful when buying new tires, it is not a safety rating or guarantee of how well a tire will perform or how long it will last. Other factors such as personal driving style, type of vehicle, quality of the roads, and tire maintenance habits have a significant influence on your tire's performance and longevity.

Tread wear grades are an indication of a tire's relative wear rate. The higher the tread wear number is, the longer it should take for the tread to wear down. For example, a tire grade of 400 should wear twice as long as a tire grade of 200.

Traction grades are an indication of a tire's ability to stop on wet pavement. A higher graded tire should allow you to stop on wet roads in a shorter distance than a tire with a lower grade. Traction is graded from the highest to lowest as AA, A, B, or C.

Temperature grades are an indication of a tire's resistance to heat. Sustained high temperature (for example, driving long distances in hot weather), can cause a tire to deteriorate, leading to blowouts and tread separation. From highest to lowest, a tire's resistance to heat is graded as A, B, or C.

Tire Fundamentals

Federal law requires tire manufacturers to place standardized information on the sidewall of all tires. This information identifies and describes the fundamental characteristics of the tire and also provides a tire identification



number for safety standard certification and in case of a recall.

Information on Trailer Tires

Please refer to the following photo:

- **ST:** The ST indicates that the tire is for trailer use.
- **Next number:** This three-digit number gives the width in millimeters of the tire from sidewall edge to sidewall edge. In general, the larger the number, the wider the tire.
- **Next number:** This two-digit number, known as the aspect ratio, gives the tire's ratio of height to width. Numbers of 70 or lower indicate a short sidewall for improved steering response and better overall handling on dry pavement.
- **R:** The R stands for radial. Radial ply construction of tires has been the industry standard for the past 20 years.
- **Next number:** This two-digit number is the wheel or rim diameter in inches. If you change your wheel size, you will have to purchase new tires to match the new wheel diameter.



Tire Safety Tips

Preventing tire damage:

- Slow down when crossing over a pothole or other object in the road.
- Do not run over curbs or other foreign objects in the roadway and try not to strike the curb when parking.

Tire Safety Checklist

- Check tire pressure regularly (at least once a month or every 50 miles, whichever comes first), including the spare tire.
- Inspect tires for uneven wear patterns on the tread, cracks, foreign objects or other signs of wear or trauma.
- Remove bits of glass and other foreign objects wedged in the tread.
- Make sure your tire valves have valve caps.
- Check tire pressure before going on a long trip.
- Do not overload your vehicle. Check the tire information placard for the maximum recommended load for the vehicle.
- When towing the trailer, remember that some of the weight of the loaded trailer is transferred to the towing vehicle.
- For more information, visit www.nhtsa.gov or call (888) 327-4326.

Brakes

Most Axis trailer brakes are “surge” brakes, which can be effective and helpful particularly when towing heavy loads. (*NOTE: Not every jurisdiction allows surge brakes. Check with authorities in the area in which you will be towing.*) Trailers may be equipped with optional electric brakes instead. Information follows regarding that type of braking system.

When the tow vehicle slows or stops, the trailer's momentum moves against the hitch ball and causes hydraulic pressure in the master cylinder (located in the trailer's tongue) to transfer pressure through the brake lines, causing the brakes to engage.

The trailer brakes should always be maintained in top condition. This includes regularly checking the fluid level in the actuator. The loss of brake function can result in loss of control or the inability to stop the trailer, which could lead to serious injury or death.

See the information provided in this section of the manual about the breakaway cable. The breakaway cable should **NEVER** be used as a substitute for braking or as a parking brake.



WARNING

Note that if the breakaway cable has been engaged—even slightly, as can happen when the trailer is disengaged from the tow vehicle and the cable is tripped over—it can cause the cable clip to break. If the cable clip is missing, or it has been broken, first check and attempt to release the emergency brake mechanism by pressing up on the brake release tab under the actuator nose, right behind the tow ball insert location. Press up on the brake release tab, and if a metallic clunk or sound of spring releasing is heard, that means the emergency brake mechanism had previously been engaged. When pressing up on the brake release tab, if it moves up and down freely with just the resistance of its spring, then the emergency brake system was likely not previously engaged. If the cable clip is broken or missing, the breakaway cable cannot operate properly. Such failure could result in serious injury or death.



The photo shows a broken clip.

Note that brakes will be submerged when the trailer is backed into the body of water to unload or load the boat. If the brakes (and/or wheels) are hot, it is recommended to wait briefly and allow them to cool before submerging.

Excessive heat in the wheels as a result of road use, meeting cooler water can cause damage to the components, especially the calipers and rotors. Also, if the trailer is submerged in salt or brackish water, be sure to carefully and completely rinse the entire trailer after the outing. Salt and exceptionally dirty fresh water can cause damage to the trailer components, which is not covered under warranty.

NOTICE

Salt and brackish fresh water can damage trailer components, which is not covered under warranty. Always clean the trailer with a freshwater rinse and/or use of mild soap after an outing in which parts of the trailer have been submerged.

Regarding routine maintenance, you need to be aware that small amounts of rust will build up on the brake's rotor surface if the trailer sits for a fairly short period of time, as little as a week. The brake's pads will eliminate the rust after several applications of braking, but if the trailer has been sitting for a more-extended period of time, and especially following long-term storage such as over the winter off-season, the brakes may be significantly corroded. This can also happen if the trailer has been submerged in saltwater and has not been sufficiently rinsed with fresh water afterwards. Greater concentrations of rust may require assistance from your authorized Axis Trailer dealer to ensure ongoing proper functionality.

If there is any concern about the condition of any component of the braking system, have an authorized Axis trailer dealer review and rectify the matter before towing the boat.

How to Manually Bleed the Brakes

Because of the importance of correctly performing this procedure, Axis strongly recommends that this be done only by trained service technicians at your authorized Axis Trailer dealer. However, recognizing that brake issues arise and may have to be addressed in situations in which the trailer cannot be taken to the dealer for repair, the following instructions are provided with the understanding that they should be utilized only in emergency.

- Check that all hydraulic fittings are secure.
- Read and understand all instructions before starting.
- Two people are required for manual bleeding.

- Step 1: Remove the master cylinder reservoir plug and fill the reservoir with brake fluid, being careful not to spill any fluid on the paint as it will cause damage.
- a. DOT 3 Premium is the preferred automotive brake fluid. Follow the instructions on the brake fluid container.
 - b. Avoid shaking the brake fluid container and pour fluid slowly to minimize air entrapment.
 - c. Let the fluid in the reservoir stand until it is completely free of air bubbles.

Step 2: **IMPORTANT:** Before bleeding the brake lines, bleed the actuator master cylinder. Insert a screwdriver



- though the hole in the bottom of the inner member and use short strokes to pry on the push rod (while holding the safety release bracket up) until no air bubbles are seen coming from the small orifice hole in the bottom of the master cylinder reservoir.
- Step 3: Start the bleeding procedure on the brake farthest from the master cylinder.
 - Step 4: At the brake assembly, connect a transparent bleeder hose to bleed screw fitting on wheel cylinder and submerge free end into a container partially filled with brake fluid. Do not reuse this fluid.
 - Step 5: The first person should stroke the push rod slowly while holding the safety release bracket up.
 - Step 6: The second person opens the bleed screw fitting.
 - Step 7: Then close the bleed screw fitting **before** the first person **slowly** releases the push rod.
 - Step 8: Repeat this procedure until the fluid expelled from the bleeder hose is free of air bubbles.
 - Step 9: Remember to always tighten the bleeder screw before releasing the push rod. During this procedure, the master cylinder reservoir fluid level must be maintained at no less than half full.
 - Step 10: Repeat Steps 4-9 for the other brake, as well as the brakes on the front axle of tandem or triple axles.
 - Step 11: If installation is on a tandem-axle or triple-axle trailer, repeat the bleeding procedure on the rear axle brakes for a second time to assure purging of all air in the system.
 - Step 12: As a final check after bleeding is completed, stroke the push rod and check to be sure the brake system is pressurized. This is done by attempting to rotate a tire around.
 - Step 13: Push up on the safety release bracket to ensure that the push rod is in the released position.
 - Step 14: After the bleeding is completed, recheck the fluid level in the master cylinder. Fill the master cylinder reservoir to the indicator on the reservoir plug. **Do not overfill.**

Optional Electrical Brakes

As an option, Axis offers electrical brakes. The system uses electric power from the towing vehicle to drive the hydraulic power source. In a breakaway situation, the electric power is supplied by a breakaway battery connected to the towed vehicle brake actuation system. This battery is charged by a charger built into the control circuitry.

The actuator reacts in one of three ways: primarily, it turns on when the brake pedal of the towing vehicle is depressed. If due to road conditions it is desirable to apply only the towed vehicle brakes, this is achieved by applying the manual override on the in-cab brake controller. In a breakaway situation, the towed vehicle braking system is applied by the breakaway switch, which is explained elsewhere in this section of the manual.

The system requires an in-cab electric brake control not provided as part of the system. The system will operate from most electric brake controllers **when properly installed.**

Proper electrical wiring is **critical** for the performance of the braking system. Improper wiring can result in damage to the actuation system or system failure after initial use. A pure ground and direct power (+12 VDC) with fuse or circuit breaker (30 amp) are necessary to ensure good performance. Line losses and poor grounding will result in poor performance or total loss of towed vehicle braking. The connection for the system is provided by prewired harnesses, and the plug connectors are keyed so that they cannot be connected incorrectly. However, if the plug between the towing and towed vehicles is not wired properly, the unit will either not function at all or will function improperly.

When Towed by 2006 Mid-Year or Later Ford, Chevy, GMC Truck Equipped with a Factory Brake Controller

Any Axis trailer with the electric over hydraulic brake system installed and towed by a 2006 mid-year or later Ford, Chevy or GMC truck may experience towing issues if the truck is equipped with an optional factory-integrated trailer brake controller.

These trailer brake controller systems are intended to assist with the trailer braking process. Because of the way these systems are designed, however, they can prevent the electric trailer braking system from engaging as intended.

This is NOT a malfunction of the Axis trailer.

New in model year 2021 was an electric over hydraulic brake system equipped with an adapter for 2006 mid-year or newer Ford and Chevy factory-integrated trailer brake controllers. If you have a newer model year vehicle, test the brakes before leaving the dealership. If the brakes are not working correctly, it takes only a matter of minutes to plug in the adapter.

! WARNING

The trailer brakes should always be maintained in top condition. This includes checking the fluid level in the actuator regularly. The actuator access location is via a cap on top of the trailer tongue. The loss of brake function can result in loss of control or the inability to stop the trailer, which could lead to serious injury or death.

- The breakaway cable should **NEVER** be used as a substitute for braking or as a parking brake.
- Periodic inspection should be made of the electrical connector, wiring, brake lines, and hose for the entire brake system to ensure there are no abraded or bare wires, damaged steel lines, or cracked and damaged hoses. During inspection verify that there are no loose or hanging lines or wire that might drag or catch on objects/debris while being towed.
- If there is any concern about the condition of any component of the braking system, have an authorized Axis trailer dealer review and rectify the matter before towing the boat.
- **Prior to EACH towing:** Check the fluid level in the reservoir on the trailer frame. The fluid level must be maintained with 3/8" to 1/2" below the filler opening. If brake fluid is needed, add only **new, clean DOT3 Premium Brake Fluid**. Use caution when removing the filler cap to prevent the introduction of dirt and/or contaminants into the fluid reservoir.



! CAUTION

Do not use brake fluid drained from the brake system to refill the master cylinder reservoir as such fluids contain contaminants from the system that may result in brake failure or costly repairs.

- Check to be certain the breakaway battery is charged and that the breakaway works. This is accomplished by pulling the cable on the breakaway switch. If the vehicle has been parked for extended periods of time, the breakaway battery may be discharged. If that occurs, charge the breakaway battery in accordance with the manufacturer's recommendations prior to operation. If the battery is allowed to discharge in a cold environment there is a possibility of freezing, which could cause damage to the battery. Such damage may not be covered by warranty.
- Again, use caution when handling brake fluid as spilled fluid will damage paint.

! WARNING

Appropriate installation, maintenance, and repair procedures are essential for the safe, reliable operation of vehicle brakes. Anyone who undertakes to maintain or repair vehicle braking systems must establish that they neither compromise their personal safety nor the vehicle integrity by their choice of methods, tools, or parts.

ADDITIONAL OPTIONS

Wheel Chocks

Wheel chocks, where equipped, are stored under the trailer fender (one on each side) and secured with a pin. The chocks can be especially helpful in maintaining position when parking on hills or in areas in which parking needs to be firmly fixed. The chocks should be placed on the downhill side of the rear tire, and then returned to the stowing position under the fender, when not in use.



Depth Alarm

To assist with backing into the water to a depth sufficient to allow safe unloading of the boat, Axis offers an optional depth alarm on all its trailers. When the correct depth has been achieved, a sensor sends an alert to an alarm on the bow stand. The alarm will sound until the tow vehicle is placed in Park (or a forward gear on manual transmission-equipped tow vehicles).





Bow Safety Strap

While the strap is sold as an option, some states require a bow safety strap. Verify with your authorized Axis Trailer dealer whether this is necessary.

The bow safety strap is a secondary point of security in case the bow winch should fail or not be secured properly. Where installed and used, be sure to attach the clip to the bow eye of the boat.



Failure to properly attach the bow safety strap clip to the bow eye of the boat could result in the boat becoming unattached during operation of the trailer. Such failure could result in damage to the boat and/or trailer, which is not covered under warranty. Under extreme conditions, the boat could become unattached to the trailer and damage to other vehicles on the road, which can result in serious injury or death.

TOWING ADVICE

Prior to Towing

- Be certain that you have a jack and lug wrench that will work on the tow vehicle and the trailer. The same ones may not work on both, so verify that you are prepared. You don't want to end up on the side of the road and find that you are not fully prepared.
- In addition to the spare tire that can be mounted on the trailer spare tire mount, also have available in your tow vehicle's storage area such useful additional items as:
 - Extra lug nuts;
 - Wheel chocks (especially important in areas in which there are hilly or mountainous driving conditions). The wheel chocks are also offered as a hidden wheel chock option;
 - Wheel bearing grease;
 - Marine grade grease;
 - Spare tie-down straps;
 - Additional brake fluid for the actuator;
 - A torque wrench to check and ensure the lug nuts are properly torqued;
 - Road flares.

Pre-Tow Check List

- Verify the coupler, hitch, and hitch ball are the correct, specified size and fit.
- Be certain the safety cables and breakaway cable are correctly attached.
- Check that tie-downs and the winch strap are secure.
- The wheel lug nuts are properly torqued.
- The tires are inflated to the air pressure level stamped on the sidewall.
- The trailer lights are operating properly.
- The brakes are functioning as designed.
- If the boat is equipped with a tower, it must be either upright and locked, or lowered and secured. If the tower is upright, you will need to determine that the total height of boat, trailer, and tower will be able to clear power lines, bridges, overpasses, or any other impediment.
- The total load does not exceed the GVWR.



Underway

Towing is more challenging than driving down the road in a single vehicle. Therefore, you would be well-advised to practice before undertaking a genuine tow to a body of water for an outing.

Axis cannot anticipate every possibility that will arise and assumes no responsibility for the operation of your tow vehicle and/or trailer, but the following are some recommendations that can enhance the towing



experience and better prepare drivers:

Drive sensibly. You will have a substantially greater length and weight to maneuver. This means you need more time and space to accelerate or to stop. Weather conditions are amplified. Wind especially can create more challenges in maintaining control.

Use those mirrors. Most tow vehicle manufacturers recommend adding oversized mirrors. Some legal jurisdictions require it. Regardless, the better you are able to see, the more control over the total rig you'll have. Larger mirrors can also assist you in keeping an eye on the trailer and boat to be aware of how well they are moving down the road.

Allow extra room when making turns. You will quickly learn that turns, especially right turns, take more space. You've seen this with tractor-trailer units and other tow vehicles.

Think twice and allow extra room when passing other vehicles. It will take longer to accelerate to passing speed, and you will need considerably more room when moving back into the driving lane. Passing on grades is not recommended as it is more difficult to maintain overall control. It may be necessary to downshift gears in the tow vehicle when passing, too. Avoid road shoulders, especially narrow ones. If you go off the paved surface, especially at highway speed, you may lose control or even jackknife the rig.

Use common sense. All the potential issues that cause potential problems when driving a regular highway vehicle are exaggerated when towing. Avoid tailgating, jack rabbit starts and stops, or any maneuver that exceeds the capabilities of your rig. Any time your rig fish-tails, stop and determine what the cause is. Often it is shifting weight, particularly within the boat or on the trailer. Readjusting the towed items may take a few minutes but can save your life and others'.

LAUNCHING AND RELOADING THE BOAT FROM THE TRAILER

Releasing the boat from the trailer requires skill as well. Conditions may vary from location to location, too. It is important to pay attention to surroundings and plan the release to avoid damage to the boat, trailer, and dock/ramp.

See the information in this section of the manual regarding the optional depth alarm. That functionality can make loading/unloading your boat considerably easier.

For boats not equipped with the depth alarm, you should first examine the ramp. Some are unimproved while others are paved, and many are something in-between. You will also need to know the ramp's steepness as that affects how far you will need to back the trailer into the water. You need confidence that the ramp surface will support the weight of the trailer and boat as you ease back, and that you will not bog down in the water or on the land surface. Sufficient width, especially if you are inexperienced in backing up, is important, too. Consider that the land may also be slippery if wet, which can affect control over the rig.

Before backing into the water, double-check that your boat is ready for launch. **This includes ensuring that the drain plugs are installed on the boat to avoid swamping and potentially flooding it.**

Then you should release the tie-downs except the winch.

Slowly back the trailer and boat into the water. If possible, have a second person standing by (but never directly in back of the rig) to help guide you. When backing up, note that the trailer will go in the opposite direction to the direction in which the tow vehicle steering wheel is turned.

Back up in the water until the front fender is about 4" underwater for a single-axle trailer. For a tandem-axle trailer back up until the front fender is approximately 2" under water. For triple-axle trailers you'll back up until the front fender is about 2" out of the water.

Place the tow vehicle in Park (or a forward gear if the tow vehicle has a manual transmission) and shut off the tow vehicle engine. Set the parking brake.

After checking that the water depth is sufficient for your boat's hull (it should not contact the ramp surface or ground underwater), release the trailer winch latch-and-hook. When all tie-downs are released, back the boat into the water and secure to a dock as described elsewhere in this manual or anchor while you remove the tow vehicle and trailer from the ramp.



To reload at the conclusion of your outing, reverse the process. When the trailer is in position, verify that the trailer bunks on which the boat will rest are free of dirt, sand, or other debris that could scratch the boat hull. It is a good idea to back the trailer sufficiently to wet the trailer bunks completely as this will add to protection for the hull when the boat is loaded.

Directions and suggestions for driving the boat onto the trailer are provided elsewhere in this manual. This requires practice to master, but correctly loading the boat is critical for both safety and protection of the condition of the boat and trailer.

Be sure that the tie-downs are secure prior to towing.

CAUTION

Submerging part of the trailer in water will cause the brakes to be wet. See the Brake information in this section of the manual regarding care following an outing. Also, be aware that while the brakes are wet, they will not work as quickly or efficiently as normal. As soon as they dry, the brakes should resume their normal characteristics.

Cleaning, Maintenance, and Storage

Aquatic invasive species (AIS) are plants and animals that occur in waters in which they are not native and whose introduction causes or is likely to cause economic or environmental damage or harm to human health. AIS have a negative impact on the waterway, its native species, and recreational and commercial uses of the waterway. As responsible boaters and citizens, each boat owner should do their part to prevent the spread of these aquatic hitchhikers. In many cases, it is also required by law.



**STOP AQUATIC
HITCHHIKERS!™**

Be A Good Steward.
Clean. Drain. Dry.

StopAquaticHitchhikers.org

One common way that species may be moved during recreational boating and other activities includes attaching to watercraft and trailers. Just one organism, or in some cases a piece of a plant, is enough to start a new invasion. Please ensure you clean off visible aquatic plants, animals, and mud from all equipment before leaving water access. For more information on flushing the ballast system, please see the *How it Works* section of this manual.

Proper cleaning, including corrosion prevention, and maintenance are critical to ensuring the long life of your Axis trailer. That information, along with requirements for storage (periods of time exceeding a week) are found in the *Care and Maintenance* section of this manual.

Please carefully review that information and follow it throughout the time of trailer ownership. Note that failure to follow the care and maintenance procedures as described in the *Care and Maintenance* section of this manual can result in damage to the trailer that could cause component failure over time. Damage due to neglect is not covered under warranty. It can also result in trailer failure that could potentially cause serious injury or death, not only to those in the tow vehicle but also to others on the road in the vicinity.



AXIS FUEL SYSTEM

Axis models are equipped with the most up-to-date fueling system available in the marine industry. The boats feature pump-in-tank (PIT) fuel systems, which means the fuel pump is located securely inside the fuel tank rather than at the engine. There are many benefits to the PIT system, most significantly in the prevention of vapor lock and improved filtration of contaminants.

To maximize the benefit of this type of fuel pump, the entire system is under high pressure. That means that access to the pump and fuel filter is only through fuel lines with a significant pounds-per-square-inch (PSI) pressure to ensure proper operation. As such, no one can or should ever attempt to access any portion of the fuel system without proper training and proper equipment. **The fuel lines are covered in orange “fire-sleeve” protective covering so that they are easily identifiable, and consumers should always avoid these lines, unless it is noted that one is squeezed or pinched.** If it is possible to alleviate this situation safely, then do so. The preferable method, however, is to have an authorized Axis dealer’s trained service technician do so and verify that no damage has been done to the line or other equipment.

Normally, if there is any issue arising from damage or leakage in the fuel system a strong odor of gasoline will be present and signifies that the engine should not be started due to the danger of explosion from fumes. Even in the absence of a gasoline odor, owners and operators should always visually check the fuel system prior to operation, as directed in the *Care and Maintenance* section of this manual.

DANGER

The fuel system, including the fuel lines, filter, and pump, should never be serviced by any person other than an authorized Axis-trained service technician. Special tools and training are required to safely service the fuel system on all models. When opened or penetrated, the high-pressure lines can cause serious injury or death.

DANGER

The flammability of gasoline and its explosive properties must always be respected. At the first odor of gasoline, the engine should be shut off and remain off until the source of the odor has been identified and the issue has been rectified.

DANGER

Never smoke or operate any spark-producing object within a 50-foot range of the boat when fueling. Fumes from gasoline are more likely to produce an explosion and/or fire than the actual fuel.

DANGER

If fuel is spilled, always clean up with dry rags and dispose of properly on shore.

NOTICE

Use of incorrect fuel can result in damage to the engine that is not covered by Axis or the engine manufacturer if such is other than Axis. Failure to follow maintenance requirements may also void the warranties.

NOTICE

Review the *Engines* section of this manual for important information regarding the proper fuel to use, how to maintain the fuel in use, how to maintain the fuel if the boat will not be used for a period of time, and other important information regarding the safe use of gasoline in the boat.

Axis recommends returning to shore and refueling whenever the fuel gauge indicates that the fuel load has fallen below one-quarter (1/4) of a tank full. **It has been determined that continuous operation with ballast significantly loaded either port or starboard (rather than evenly distributed) can result in damage to the fuel pump as it attempts to compensate.** Also, even with the best of care, some water may get into the fuel tank or



separate from the fuel that is pumped into it. If there is water present, it will settle on the bottom of the tank. If the pump begins to reach any water, it may cause malfunctioning in the engine.

When pumping fuel, do not leave the nozzle unattended in the fuel fill. Although the fuel system has been manufactured to avoid spit-back of fuel, and most gasoline dispensers will shut off if removed from fuel fill, it is always a wise consideration to provide full attention to the process.

OPERATIONS

Final Checks Before Starting

Before getting underway, operations checks should be completed to ensure a safe and enjoyable outing.

Verify that:

- All safety requirements as outlined in the *Safety* section of this manual have been met.
- Review the prelaunch requirements as outlined by the trailer manufacturer, and the preparations as required by the engine/drivetrain manufacturer.
- The total number of people and gear onboard does not exceed the maximum allowed and as indicated on the capacity plate. These informational plates are located in the interior walk-thru.
- All gear is properly stowed. Gear that is left loose on the deck can become dislodged, move about during operation and could potentially go overboard or strike an individual onboard, resulting in potential injury.
- A float plan or outing information has been left with someone ashore. This means that if any issues arise, there is a person to raise an alarm if you do not return as planned. (Cell phones are helpful, but sometimes service is not available, so this should not be the only plan in the event of problems.)
- Ensure there is sufficient fuel in the fuel tank for the outing or have a plan for refueling.
- Be sure that the weather forecast does not include threatening conditions. Also check predicted wind and water conditions.
- Check that the drain plugs are fully and correctly installed.
- Ensure that PFDs and other safety gear are onboard.
- Be sure that all onboard fire extinguishing equipment is fully charged and easily accessible.
- Go through the pre-outing maintenance checklist, as outlined in the *Care and Maintenance* section of this manual.
- Give all the onboard equipment and components (such as the tower) a final check to be certain that everything is secure and ready for the expected boating conditions.

STARTING AND OPERATION

Prior to starting the boat for the first time, read this entire manual. Before towing to the body of water the first time, read the entire *Trailers* section of this manual as there is important safety information contained within it also. If the boat came with additional handout materials or other owner's manuals specific to various boat components, also read that material in its entirety.

All of these publications have been developed to protect boaters, their passengers, other people on the highways on the way to the body of water, and others who are also boating. Information is provided to enhance enjoyment of the Axis experience, as well as how to care for and maintain the boat, engine, drivetrain, components, and trailer so that this will be a long-term, ongoing source of enjoyment.

STARTING THE ENGINE

- Step 1: Be certain the boat's shifter/throttle is fully upright in the neutral position. Additional information follows regarding shifting and throttle response.
- Step 2: Perform the pre-start routine, including the bilge inspection and engine compartment inspection (Details are provided in the *Care and Maintenance* section.) Leave the engine compartment open for the starting process.



Step 3: Attach the emergency safety switch tether/lanyard to the switch of the shifter/throttle, and also to a piece of the operator's clothing.

Step 4: Turn on the battery isolator switch. Press the power button and ensure the 7" displays power up. After the screens boot, the blower should start automatically. Allow the blower to run for at least four (4) minutes with the engine compartment open while the boat is in the water. It is extremely important for any accumulated fumes to be vented in this way. It also assures that any new issues that arise involving the engine, fuel system, and ventilation system are noted. Accumulation of fumes within the engine compartment can also lead to an explosion.



Step 5: Press the Start/Stop button for approximately one (1) second and enter the Start Code on the 12" display. **The default is 1-2-3-4, but boat owners can change this by following directions provided in the *Dashes and Video Screens* section of this manual.** If using the key switch to power ON the system, please be aware that a safety feature will be enabled that turns the navigation and anchor lights on.

Step 6: If for some reason the engine does not start, repeat Step 5. Never press the button for an extended period. If the engine does not start as it should, make sure the throttle/shifter is in neutral. If it still does not start, then refer to the *Troubleshooting* section at the conclusion of this manual for assistance in determining the cause. If any alarms sound or warning lights appear, turn OFF the engine and troubleshoot. There is also a back-up ignition key on the starboard shifter panel, next to the breaker panel. Start this as you would a land-based vehicle. Never press the button for an extended period. If the engine does not start as it should, make sure the throttle/shifter is in neutral. If it still does not start, then refer to the *Troubleshooting* section at the conclusion of this manual for assistance in determining the cause. If any alarms sound or warning lights appear, turn OFF the engine and troubleshoot. There is also a back-up ignition key on the starboard shifter panel, next to the breaker panel. Start this as you would a land-based vehicle.



To prevent a possible explosion, always operate the blower for four (4) minutes prior to starting the engine and continue to operate with the engine compartment open for several minutes after starting the engine. Always operate the blower when the engine is idling or at a low running speed. Improper ventilation can lead to accumulation of gasoline or exhaust fumes in the compartment.

TO TURN OFF

To turn OFF the engine, press the Start/Stop button and hold for approximately one (1) second. If the backup key switch was used to start the boat, ensure that the power button is OFF and then turn the key to OFF. Failing to verify that the power button is off means the electrical system will continue to function and the engine will continue to run.

Note that, unlike a dry-land vehicle, turning off the boat does **NOT** immediately stop its momentum. The boat will continue to move. Shifting to neutral will slow progress, but allowance must be made for continued movement. See information following for suggestions regarding docking.

The power button is a safety measure. It allows the operator an opportunity to briefly and visually check the electrical system operation prior to starting. The key also reduces the likelihood of boat theft of the boat or unauthorized use. Always remove and take the key with you when the outing is done.



BREAK-IN PERIOD

The first hours of the boat operation have critical requirements for engine break-in. This information is contained in the *Engines* section in the manual, where appropriate. Be sure to review this information carefully. **Failure to follow the instructions will void the engine warranty!**



With regard to the boat, pay close attention to the screens, and monitor the readings. Pay particular attention to the oil pressure and engine temperature information as these are the earliest warnings when something is going wrong with the drivetrain. Alarms will sound if serious problems are encountered.

Also, check carefully for leaks. The break-in period is the most likely time for leaks to appear, whether fuel, oil, water, or exhaust.

SMART OPERATIONS

Newcomers to boating, especially boats the size of the Axis models, are strongly encouraged to take a U.S. Coast Guard boating class before using the boat. Reading about boating conditions and operations from websites such as the National Marine Manufacturers Association (NMMA) and the many yachting association sites can be very helpful.

Practice, practice, practice! Begin in optimum weather and water conditions, avoiding tight quarters until you are comfortable. The boat actually steers more easily when the boat is on plane. This is achieved by speeding up briskly from idle. By throttling and increasing the speed, the boat will ride up higher on the body of water. With less friction between boat hull and water, the boat will maneuver more easily. At slower speeds, the boat is less responsive, so practice is important to achieve the kind of maneuverability that is desirable.

Remember that steering in a boat is from the rear (stern). The unseen rudder operates from the steering wheel, but the actual steering through the rudder is different from a car. Note that stern control means that the boat will push away from the direction of the turn. The bow will follow a smaller turning circle than the stern does.

Note that the propeller does not move the boat directly forward. Due to the rotation (generally, counterclockwise), the boat's natural progress will have a slight tracking to the port side (when in forward gear) and starboard side when in reverse. At slower speeds, this phenomenon is more pronounced. Depending also on the body of water depth and width, it may be necessary for the operator to compensate for this natural movement.

STOPPING

The lack of brakes requires the operator to think more quickly and react accordingly to avoid damaging contact with other boats, docks, and the shore. When stopping the boat, it is acceptable to use reverse gear (much as airplanes use reverse thrust). This is a technique that takes time and practice to master. Slamming from forward to reverse gear can damage the system. Allow sufficient time to move the shifter from forward to neutral, briefly pausing with each shift, and then ease into reverse. Always slow to a no-wake speed before attempting these shifts and do not shift into reverse if the boat is moving faster than two (2) mph (3.2 km/h).



WARNING

Do not disconnect the emergency safety switch as a method to stop the boat. Doing so impairs the ability to restart the engine quickly or it may create a hazardous swamping condition.

HIGH SPEED MANEUVERS

Competitions may showcase the driving skills of professional operators. Tempting as it may be to try the same kind of extraordinary maneuvers, the vast majority of operators should avoid boating at top speed. Professionals are trained to plan and prepare in the event something goes wrong.

The engines are built and tuned to run at the optimum speed range for water skiing, wakeboarding, wake surfing, and similar activities. Higher speeds are achievable, but the intent is only brief bursts of speed in those instances where the Axis operator needs to move quickly to get out of a potentially dangerous situation.



DANGER

Attempting to replicate the high-speed maneuvers of professional boat drivers can lead to loss of control, damage to the boat, and serious injury or death to the operator and passengers.

Weather conditions and altitude can affect the best operating range for the engine. If you feel that you are not



getting the expected performance from your boat, contact your authorized Axis dealer to discuss changing or adjusting the propeller to compensate. Do not attempt to do this without assistance as it may void the boat and/or engine warranty.

SPECIAL CONDITIONS

Boating regularly on the same body of water will assist the operator in anticipating conditions under normal circumstances. But for boaters who try different locations or even in instances where conditions are abnormal at a known location, operators should seek advice from local sources. Do not launch when threatening weather is in the area. If there has been recent flooding, there may be additional floating debris. If a drought is occurring, a lowered water level may result in submerged hazards becoming exposed. Avoid brackish or weedy areas, too. The flora can become entangled in the propeller and cause problems. Smaller material can become lodged in the water intake for the engine and transmission. Fouling from natural materials can result in damage to the drive train that is not covered under warranty.

TOWING AND INTERACTION

Activities behind the boat require interaction between the driver, an observer, and the sport participant. See the Safety section of this manual for information about hand signals and safe pick-up of a downed skier/boarder/swimmer. The driver is responsible for the well-being of all aboard, plus any people outside the boat who are engaged in sports that are a result of operating the boat.

Under normal circumstances, Axis boats should not be used to tow other boats. Towing other boats should be undertaken only as a last resort, when other, more appropriate, towing is unavailable. The stress caused by towing lines, along with the difficulty in controlling the disabled boat, could cause damage to the towing boat as well. Always attempt to secure assistance from shore and rescue organizations such as the U.S. Coast Guard. Never tow a boat that is the same size or larger. A tow line should attach only from the stern eyes to the bow eye, with sufficient line to avoid contact between the two boats. Do not use three-strand twisted nylon rope as it has too much elasticity. Lines need to stay free of propellers on both boats. Never hold on to the rope after it is taut.

Only boat operators with knowledge of correct technique should undertake to tow. Move slowly to prevent strain on the line and be ready to cast loose or cut the line if conditions become hazardous.

ANCHORING

Consult with your authorized Axis dealer regarding the best selection for an anchor and how to properly attach it to your boat. Always anchor from the bow of the boat as it has less chance of breaking free if a heavy wind occurs or water conditions worsen.

DOCKING AND TIE-UP

Docking a boat requires considerable practice to be effective and avoid damage to the boat. Docking must always be done at slow speed.

Before attempting to dock, practice in an open body of water. Slow the throttle to no-wake speed. Shift into neutral and drift slowly toward the dock. If necessary, shift the boat into reverse to further slow or stop the boat.

WARNING

Never insert a hand, arm or other body part between the dock and the boat or attempt to keep the boat from hitting the dock. The boat could push against the dock, pinning the appendage, and cause severe injury.

The following are recommended guidelines for docking:

- Approach the dock with the starboard side of the boat, if possible. You will be able to see the edges of the dock and boat better.
- Come to a stop at a short distance from the dock, and then proceed slowly (no wake).
- Have fenders (where equipped), mooring lines and crew ready.
- Observe how the wind and current are moving the boat. Approach the dock with the boat pointed into the wind, if possible.



If the wind or current is pushing you away from the dock, use a sharper angle of approach. If you must approach the dock downwind or down current, use a slow speed and shallow angle. Be ready to reverse to stop and maintain position.

- If there is no wind or current, approach the dock at a 10-to-20-degree angle.
- If possible, throw a line to a person on the dock and have that person secure a bow line.
- With the bow secure, swing the stern in with a slight throttle and turning of the steering wheel, or pull it in with a boat hook.

Before tying up the boat, it is advisable to use enough fenders (an additional, optional purchase) to protect the boat from damage. It is necessary to tie up with some slack in the line, as tying tightly will cause the boat's finish to rub repeatedly against the dock due to wave or tidal action, but if there is too much slack the side of the boat may hit (and damage) the finish.

Tie up with the bow toward the waves, if possible, with a good-quality, double-braided nylon line. Tie up only to the lifting eye (under the forward bow point) or tie-down eyes (each side of the transom), or optional cleats. Never use the handrails or windshield frame, or any other component of the boat. If the boat will be moored for an extended period of time, use chafing protectors on the lines to protect the gel coat finish.

When leaving the dock, untie the lines and return them to the boat deck to avoid snagging on any object on the dock. (Also, stow the lines so that the operator and any passengers will not trip on the lines or become entangled.) Move very slowly away from the dock, unless the wind/current are naturally pushing the boat away from the dock, where it is possible to drift until safely free of the dock.

Always be certain to visually check that the center and transom drain plugs are installed and secured prior to deploying the boat in any body of water. The boat operator must still physically check that the drain plugs are installed and properly secure.

AQUATIC INVASIVE SPECIES

Aquatic invasive species (AIS) are plants and animals that occur in waters in which they are not native and whose introduction causes or is likely to cause economic or environmental damage or harm to human health. AIS have a negative impact on the waterway, its native species, and recreational and commercial uses of the waterway. As responsible boaters and citizens, each boat owner should do their part to prevent the spread of these aquatic hitchhikers. In many cases, it is also required by law. Check local regulations for any waterway where you will boat. After each boating trip, follow these three simple steps before you leave the water access to stop the spread of AIS: Clean, Drain, and Dry. This is the boater's way to help protect the environment from the damage that AIS can cause.

Pathways Of Aquatic Invasive Species

We are living in a very different era where goods, people and services are being shipped around the world. Because of this globalized economy, different species are hitchhiking through many different pathways. Species can be moved to new locations in many ways, and most are a result of human activity, including recreational activities. Some common ways that species may be moved during recreational boating and other activities include:

- Attaching to watercraft, trailers, motors, and fishing gear.
- Transport by ballast, bilge, and other water containing devices.
- Dumping of unwanted live bait.
- Tangled in fishing lines and downrigger cables
- Sticking to the soles of waders
- Trapped in mud on a dog's paws

Just one organism, or in some cases a piece of a plant, is enough to start a new invasion.

General Clean Drain Dry Procedure

Clean, Drain, Dry... In every waterbody, every time.

Preventing the spread of aquatic invasive species starts with you. A cooperative effort is necessary by all persons and agencies involved with recreational activities to achieve the best results and protect our aquatic resources and recreational opportunities. The general Clean Drain Dry procedure is described as follows:



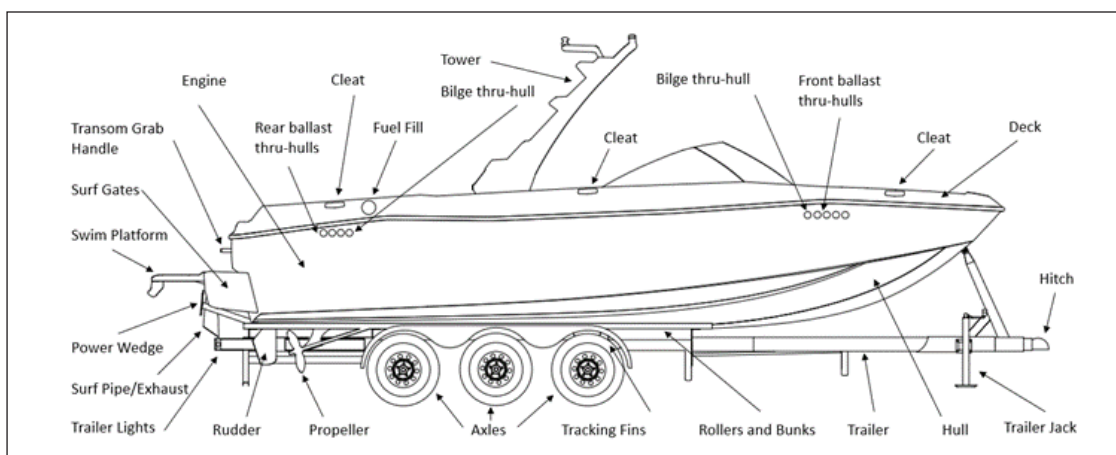

CLEAN

Clean off visible aquatic plants, animals, and mud from all equipment before leaving water access. Inspect and clean engine area, including the transmission and motor mounts; trailer, including axles, bunks, and rollers; power wedge, dock lines/cleats, surf pipe/exhaust, surf gates and actuators, propeller, rudder, transom grab handle, tower, tracking fins, and equipment before leaving the water body.

- Rinse equipment and boat hulls with high pressure, hot water (140°F) when possible.
- Rinse interior compartments of boats with low pressure, hot water (120°F) for a minimum of 130 seconds contact time.
- Flush motor with hot water (140°F) for 2 minutes (or according to owner's manual). See applicable section in *How it Works* for flushing the engine.
- Flush ballast system with hot water (120°F) in accordance with owner's manual. See applicable section in *How it Works* for flushing the ballast system.

DRAIN

Drain the engine cooling system, bilge, ballast system, and other water containing devices before leaving water access.

DRY

Allow the boat to completely dry OR wipe with a towel before reuse, before visiting any other bodies of water.

AIS Summary

Together the three steps of Clean Drain Dry greatly minimizes the risk of spreading Aquatic Hitchhikers into new locations.

- Cleaning will remove visible large-bodied organisms attached to or in watercraft or recreational equipment. Rinsing with water removes organisms, while hot water often kills them. Water at least 120°F is recommended; be sure to avoid contact with skin and check manufacturers' recommendations to ensure equipment can withstand high temperatures. If hot water is not available or may cause damage, rinsing with tap water and completely drying will help prevent spread of aquatic invasive species.
- Draining removes small and nearly invisible organisms such as zebra mussel larvae (veligers) potentially entrained in water containing devices.
- Drying is necessary as many organisms can survive in standing water.

A note about chemicals. The use of chemical prophylactics or disinfectants (e.g., bleach) are not recommended for treating watercraft and recreational equipment. Chemicals may:

- Damage equipment or components
- Cause environmental damage
- Harm human health
- May not be effective against many aquatic invasive species

Report new sightings. If you think you have found an invasive species, note its exact location and, if possible, take a photo. Report new sightings to the appropriate authorities or use the USGS Sighting Report Form (<https://nas.er.usgs.gov/sightingreport.aspx>).



Know the rules! Specimens are needed to confirm sightings, but some jurisdictions prohibit possession and transport of invasive aquatic plants and animals. Before collecting specimens, contact your local natural resource management agency for instructions. Unauthorized introduction of plants, fish, or invertebrates into the wild is illegal in most states. Protect your property and our waters.

Remember that AIS Threaten the Environment, Recreation, Economy, and Human Health. Refer to the *Stop Aquatic Hitchhikers!* Website for more details (www.StopAquaticHitchhikers.org).



STOP AQUATIC HITCHHIKERS!™

Be A Good Steward.
Clean. Drain. Dry.

StopAquaticHitchhikers.org



care and maintenance

ON-GOING CARE

General Cleaning

Axis recommends always keeping the boat clean. Immediately after an outing, the boat's exterior and interior should get a thorough rinsing with clear, fresh water, and then should be allowed to air dry prior to covering with canvas. If this is not possible, the boat's cover should be removed as soon as you arrive at your destination and allowed to dry.

NOTICE

Boats must be thoroughly rinsed inside and out with clear, fresh water following all outings and then allowed to completely dry prior to storage or parking. Failure to do so could result in damage to the finishes and the development of mold or mildew, or permanent stains. Such damage is not covered under warranty.

NOTICE

Consumers should never add aftermarket waterproofing to canvas. The canvas must "breathe" to avoid mold and mildew. If any spray-on waterproofing has been added after delivery, it will void the warranty.

If the boat will be left in water, the exposed areas should be wiped down with clear, fresh water and allowed to dry before boat covers are installed.

Canvas

Breathability of Fabrics—Air Permeability

Air permeability is an important factor in the performance of outerwear where the wind resistance helps keep the user warm. Fabrics that have high air permeability usually have low water repellency, the latter being an important feature for mooring covers. When in a slip, mooring, or parked on a trailer, the cover is not experiencing any pressure that would force air through the fabric so breathing or air permeating will not occur.

In all cases, vents that are often placed on covers provide more ability for air to move out from under the cover than the fabric's ability to breathe. It is important to note that in this "static" condition air under the cover is stagnant.

Where air permeability is most important is when towing. This is a dynamic condition and high air permeability will cause the cover to billow and buffet, lowering its life, and potentially causing damage to the surfaces it touches.

Mold & Mildew Cause and Prevention

Mold and mildew spores are ever present in air and soil, and most will germinate when exposed to temperatures above 75° F and relative humidity of 50%, with rapid spread occurring at 80%; however, some can grow in significantly lower temperatures and RH levels.

All fabrics will support growth but natural fibers like cotton, due to their cellulose component, are more susceptible than synthetics. Some synthetics are treated with an anti-microbial agent which adds to their growth resistance. Anti-microbial treatments protect the base surface itself, so that alone won't support spore growth. However, organic soiling on top of those surfaces will. Once a population is established on the cover, vinyl seating or gel coat, an irregular stain will appear which ranges in color from gray to black; however, yellow, orange, and red stains are possible. Sometimes UV exposure can fade them but most often they remain permanent stains.

Treatment

(Canvas manufacturers acknowledge this is difficult and very time-consuming, with limited expectations of success. Therefore, it is desirable to avoid the necessity of mold and mildew treatment.)

- If growth is established, vacuuming with a HEPA filter unit would be the first step followed by cleaning.
- For fabric and vinyl surfaces, shampoo lightly with an upholstery shampoo.

Focus on Prevention

The key in eliminating mold growth is controlling moisture. Remove it as a factor and growth simply will not occur,



so maintaining a cool and dry condition with clean surfaces is paramount. Using a dehumidifier isn't practical for boat storage, but a simple remedy can be using desiccant bags. They must be monitored as they will absorb moisture and become ineffective, but they can be replaced, and this is a relatively inexpensive method. They are available in packs for a normal-sized boat and called Boat Dry, purchasable from Sun Solutions at www.sunsolutionproducts.com.

When the boat is ready to store, the best practices are:

- Clean and dry the boat thoroughly.
- Place a Boat Dry set of desiccant bags throughout the boat.
- Put the mooring cover on and tightly ratchet (seal will be created at the rub rail).

Drying out a boat is difficult but the extra care you take will keep your boat looking new for a long time.

Condensation Cause and Protection

Water vapor in the atmosphere will condense onto another surface only when that surface is cooler than the dew point temperature, or when the water vapor equilibrium in the air has been exceeded. The dew point temperature is based on the air temperature and relative humidity. A typical example is with 90°F air temperature and 50% RH, the dew point temperature is about 73°F.

Many times, through the evening dew will condense onto all outdoor surfaces like grass, cars, patio furniture, toys, bikes, and the like as the air temperature and surfaces cool below the “dew point.” Once the morning sun heats the air temperature or those surfaces heat up enough, the dew will evaporate back into “humidity” and this cycle continues as long as the weather conditions permit.

When you cover your boat, you are sealing the outside air in its present state under the cover. Also, if the boat wasn't dried out, that additional moisture will add to the wetness of the trapped environment. As the air and surface temperatures cool below the dew point the water vapor in that air will condense onto all surfaces inside the boat. In the morning, it will take longer to heat the air and surfaces under the cover as it affords protection, thereby lengthening the time it takes to have the condensation evaporate. It's very possible if weather conditions change that the condensation may not return to vapor for quite some time.

This condition is often misunderstood as the cover “leaking” water through the fabric, but because of the fabric's high hydrostatic water resistance (160 cm) this is not possible. It's understandable to think that having the cover wet underneath is somehow due to it allowing water through, but it is just condensation forming on its surface. It's like camping in a synthetic tent; if you've ever done it, you'll remember water beads form on the tent surface, and bumping the tent would cause them to “rain” on you.

Pooling Water

Water can pool on a cover for various reasons. However, the Axis cover is designed to combat this by having the overall features and characteristics work in concert to maximize its resistance. The fabric choice requires it to be lightweight, high strength, coated, water repellent treated, and dimensionally stable. This minimizes the fabric adding weight, and its strength and stability allows for the necessary tight fit.

The “face” surface is treated with a water repellency, lowering the surface tension so water beads up and runs off. The “back” surface is urethane coated, providing additional defense against water penetrating the cover. The new water repellent lowers the surface tension further over traditional treatments where the water beads move sooner joining with others making them run off the cover sooner and faster. It also increases hydrostatic water resistance (the ability of fabric to resist water penetration) from about 100 cm to 170 cm.

All “face” water repellent treatments wear off and the “water beading” will lessen eventually, allowing water to be absorbed by the fabric fibers, but the “back side” urethane coating will provide the second defense of penetration.

A traditional “face” treatment lasts about six to nine months, and tests on the enhanced treatment (BW+) show it will last three to four times longer.

In all cases durability of the treatment is very dependent on the environment and use the cover experiences. Providing the enhanced water repellent as a reapply alternative isn't possible because it requires a controlled bonding process to properly attach it to the fabric surface. There are various aftermarket repellents available, but because they are mechanically attached, they usually only last about one month or so.



Maintaining Zippers and Hardware

- Lubricate zippers periodically using a clear silicone spray.
- Spray silicone on the zipper and work the zipper back and forth.
- Lubricate fasteners periodically using a clear silicone spray to keep corrosion to a minimum. Replace any missing fasteners or fasteners that show signs of corrosion.
- Do not use petroleum-based products, i.e. petroleum jelly.

Maintenance Tips

- The real key to canvas longevity is like all things in life: maintenance. Keep the canvas clean of dust, dirt, and environment residue on a regular basis.
- Top fabrics should be cleaned of any dirt buildup at regular intervals.
- We recommend applying a mild, lukewarm soap solution, such as a liquid dishwashing soap, with a soft brush or sponge. Water temperature is not to exceed 100°F. **DO NOT** allow the soap to dry. The fabric must then be carefully rinsed with clear water in order to remove any remaining soap residue. Allow canvas to dry thoroughly. **Do not use detergents.**
- The use of abrasive detergents and/or substrates containing solvents or gasoline will damage the fabric. If using high-pressure or steam-cleaning devices, use caution as improper use could damage the vinyl coating and/or fabric.
- Using harsh chemicals could void the fabric warranty on your top if not recommended by the manufacturer.
- **DO NOT PUT MARINE CANVAS IN YOUR HOUSEHOLD DRYER. DO NOT DRY CLEAN BOAT CANVAS.**

NOTICE

The performance results shown in this information are not guaranteed for all upholstery products. The evaluations are indicators after laboratory tests and may not be indicative of field performance.

Upholstery

Even if you do not have or use canvas covers, read the previous material about canvas care as there is information that is applicable to upholstery use as well.

NOTE: Topical cleaners must be wiped off with clean water and dried with a clean cloth after application. If not rinsed after direct contact, the cleaner residue on the surface can cause product failure.

Mold and Mildew

As noted in the *Canvas* information above, mold, and mildew problems in the marine upholstery industry have been well documented. The objective of this overview is to review the causes and cures of the unsightly and odoriferous problems, and to suggest actions to reduce their impact on the quality of goods as perceived by the consumers.

The Cause: Micro-organisms

The two principal causes of offensive odors and unsightly stains and growths are bacteria and fungi, commonly called micro-organisms. Bacteria are simple, single-celled organisms. Fungi, referred to as mold and mildew, are significantly more complex.

A subset of fungal organisms is a type that produces colored byproducts as part of its digestive process. These byproducts are recognized as stains and are typically pink, yellow, purple, or black.

All micro-organisms require a source of energy, carbon for cell structure, nitrogen for amino acid synthesis, essential minerals, and water.

Organisms causing problems in the marine, industrial, health care, hospitality, and home environments are frequently very self-sufficient in synthesizing required bio-chemicals from the most basic molecules. Micro-organisms are ubiquitous. They are everywhere, and thus, microbial contamination is the rule. The total absence of



microbes—sterility—is the exception.

Current Reality

To have a mildew problem, four elements are required. For mildew to proliferate, spores, food, warmth, and moisture are necessary. Elimination of one of these elements would break the cycle, and the mildew problem would be eliminated.

The most likely element to control is moisture. Keep surfaces dry and the ambient air dry, and you can break the link. This is very difficult. Marine upholstery may be dry when one sits on it, but it is constantly exposed to rain, splashes, and wet bathing suits.

Dirt carried by the wind or a sudden shower will carry the spores or seeds to begin the process, inoculating the surface. Surface debris can easily be washed off, but what happens to the contamination that gets into a seam or stitch holes?

A closer examination reveals that a marine seat is a very complex construction. The vinyl that you look at or sit on is a minute part of the total construction. The vinyl is usually attached to a fabric to give it dimensional stability and physical strength. Urethane foam of various thicknesses provides a cushion, and the whole seat is usually built on a piece of plastic.

If contaminated dirt carried by rainwater gets inside the cushion, the biological growth cycle can begin. It is quite common for soil organisms growing in the foam cushion to produce colored by-products, the most notable of which is a pink compound.

This dye is soluble in plasticizer (an ingredient in flexible PVC) and will diffuse and migrate to the vinyl surface. Even though the vinyl compound is adequately protected against mildew growth, pink staining can occur if contact is made with components of a seat which support mildew growth. This stain cannot be removed by washing.

The Solutions

As in most complex problems, there are a variety of actions one can take to prevent microbial problems. These actions must be directed to the components of the product and the total construction. Working together, they will assure the highest probability of success in eliminating quality problems associated with mildew contamination. The solution consists of four components:

- Keep seats clean.
- Remove or kill any surface growth.
- Use materials that are treated to inhibit fungal growths.
- Keep surfaces covered, if possible, when not in use.

APPROVED CLEANERS FOR AXIS UPHOLSTERY (Except Cool Tech*)

- **303 Fabric/Vinyl Cleaner**
- **All Purpose Vinyl Cleaner**
- **Babe's Boat Care Wash**
- **Coverage Plus Germicidal Wipes**
- **Fantastik Antibacterial All-Purpose Cleaner-Heavy Duty**
- **Formula 409 Antibacterial All-Purpose Cleaner**
- **Iosso Marine Products Mold & Mildew Stain Remover (in dilution of 1 scoop [1/2 oz] per quart of water)**

Above are all recommended for use, ONLY if diluted per the manufacturer's instructions. Do not use any product not listed herein.

** If your boat is equipped with Cool-Tech Upholstery, then the ONLY approved cleaning product is water with mild dish detergent.*

COMMON STAINS AND STEPS TO TREAT

- A: Medium-soft brush, warm, soapy water, rinse/dry
- B: 303 Fabric and Vinyl Cleaner rinse/dry
- C: Wipe or scrape off excess (chill gum with ice)

After all cleaning methods, rinse well with clear, warm water.



	Step 1	Step 2	Step 3
General care	A	B	
Dirt buildup	A	B	
Ballpoint ink*	B	A	
Chewing gum	B	A	
Coffee, tea, chocolate	B	A	
Grease	C	B	A
Household soil	A	B	
Ketchup	A	B	
Latex paint	A	B	
Lipstick	C	A	B
Mildew or wet leaves*	B	A	
Motor oil	C	B	A
Oil-based paint	C	B	A
Permanent marker*	B	A	
Spray paint	B	A	
Suntan lotion	A	B	
Tar/asphalt	C	B	A
Yellow mustard	A	B	

* Suntan lotion, tree pollen, wet leaves, and some other materials, including waxes, can contain dyes that stain permanently. These stains are not covered by warranty.

* No warranties or claims are hereby made that the cleaning methods will completely remove the stains and return the material to its original state.

* Attempting to clean Axis upholstery with any unapproved product may void the warranty and permanently damage the material. Failure to properly clean and maintain the upholstery will also void the warranty.

ADDITIONAL ROUTINE CARE

Soft Grip

The soft grip available through Axis is constructed of durable, marine-grade material. Occasionally washing with a mild detergent (such as Dawn dishwashing soap) and warm water is required. After cleaning, thoroughly rinse the detergent or cleaner out of the mat and into the bilge.

Allow the boat to remain uncovered for several days to air dry and avoid mold and mildew. See the *Canvas and Upholstery* sections for more information on mold and mildew development and how critical it is to avoid.

Swim Board

Axis uses high quality composites to construct swim boards. These durable boards should also periodically receive a thorough cleaning. Use only mild detergents and warm water or marine industry based cleaners that are approved for use on fiberglass and EVA foam.



NOTICE

Avoid using unapproved products in attempting to clean. These will actually accelerate deterioration of the product, rather than protecting it. Such damage is not covered under warranty.

Hull and Deck Finishes

Much of the finish surface of the hull and deck is a fiberglass-reinforced resin. While the boat material is sturdy, to ensure an enjoyable experience while boating, the fiberglass and resin layers and gel coat finish (where the paint is embedded) is very thin—only a few millimeters in depth. To keep it looking like new, it is important to keep it clean and waxed.



Only a mild detergent and warm water should be used to clean these surfaces. Avoid all harsh cleaners as they will quickly erode the finish.

If you choose to wash the boat at a car wash, do so with care. Stay back from the boat surface to avoid potential damage from the high-pressure sprayer, and do not use the soap setting as most car-wash soaps are intended to deal with highway-type debris such as salt, road tar, and similar environmental hazards. Wash the boat by hand with mild detergent as noted above, and then rinse carefully.

NOTICE

Use only a mild detergent, such as dishwashing soap, and warm water to wash the fiberglass and resin and gel coat finishes on the boat. Harsh detergents and cleaners will quickly damage the finish, and this is not covered under warranty.

SALTWATER CARE AND MAINTENANCE

When boating in brackish or salt water, the post-outing cleaning is critical for the protection of the finishes. The cleaning process, internally and externally, are critical to maintaining the warranty in effect and to preserving the engine components. This is a safety matter.

The potential for corrosion means that boats operating in this type of condition must be equipped with self-sacrificing zinc anodes. These anodes are attached in several locations, including the transom, driveshaft and rudder. Check with your authorized Axis dealer to be certain that you are aware of all locations of these as they will require periodic replacement. The anodes serve to significantly reduce the potential for corrosive damage to the permanent metal components on the boat.

Axis boats are equipped with a closed cooling system (see the *Engine* section of this manual) which reduces the amount of water utilized from the body of water during operation. However, some water is necessary and must be drawn onboard and circulated. This function exposes interior portions of the boat, particularly some engine components, to operational exposure to salt or brackish water. The explanation of how to properly flush the engine following an outing appears later in this section.

NOTICE

Failure to follow **ANY** of the Saltwater Care and Maintenance instructions for care and maintenance will void the warranty. Significant damage occurs to the engine and boat if proper maintenance is not followed as outlined in this Owner's Manual.

Stainless Steel, Chrome, and Aluminum Components

The boat has been constructed with various metal components, all of which require special attention during routine care. Decomposition occurs, resulting in rust and/or corrosion, and it is accelerated when the boat is operated in salt water. (Read carefully the *Saltwater Care and Maintenance* information that follows.)

NOTICE

Damage that occurs to the boat because of corrosion is not covered under warranty.

While Axis uses quality metal components chosen for their durability as well as attractive appearance, all metal eventually reacts to water exposure. Therefore, part of the care and maintenance of metal requires that it is kept clean and dry.

After an outing, rinse the metal pieces as well as the rest of the boat, allowing a thorough air drying. To avoid spotting and discoloring, drying with a soft rag or towel will keep the new boat look for many seasons to come. It is also recommended to wash all metal components when you wash your boat as this will help prevent moisture from affecting the surface. Waxing these metal components will also help to preserve the finish. Do not wax powder-coated surfaces as the wax will collect in the textured surface and be extremely hard to remove.

If the boat owner notices rust or deterioration of metal components below the water, even when operated regularly in fresh water, this should be brought to the attention



of the authorized Axis dealer. In some instances, it is necessary to attach self-sacrificing zinc anodes, even when operated in fresh water. Be safe, rather than sorry.

Routine Salt Water/Brackish Water Protection

After every outing perform a general cleaning of the entire boat, interior and exterior, with clean water. (See flush kit instructions, which follow.) Then reapply the Corrosion Block or WD-40 Long-Term Corrosion Inhibitor or as described in the following instructions, to the exterior of the engine.

WARNING

Boats operated in salt water, brackish water or polluted fresh water must be thoroughly rinsed with CLEAN, fresh water after EACH outing. The corrosive properties of these types of water will cause damage that is not covered under warranty! Hardware—even hardware chosen for its anti-corrosive properties—that is damaged by salt/brackish/polluted water may eventually fail, which could result in serious injury or death to persons on-board.

Although every component on the boat, including the engine, can be adversely affected by salt/brackish/polluted water, upgraded components in the Saltwater Series building process include:

- Stainless steel gas shocks;
- Grounding and bonding of all components below the waterline; and
- A sacrificial zinc anode.

Especially important to the entire protection is the sacrificial zinc anode. The anode is attached to the exterior of the boat, on the transom below the waterline. Other metal components are attached to the transom zinc anode via grounding wire. Anodes are also affixed to the exhaust manifolds.

These anodes provide a greater degree of attraction between the anode's metal and the corrosive action of the body of water than that occurring between the boat's metal parts and the water. Simply, both rust (which is oxidation) and metal reduction, are the result of operating in salt water, and the anodes' purpose is to attract and draw away much of the corrosion from the boat's metal components.



NOTICE

The sacrificial zinc anodes do not totally eliminate the corrosion process from the rest of the boat and its components. It is critical for the boat to be rinsed and flushed after EACH use. Failure to do so will void the warranty.

Axis has determined that the use of Corrosion Block is necessary to ensure long life for metal components. The use of Corrosion Block, available at www.corrosionblock.com, as directed on the bottle or can is required to keep the warranty in force. (While Corrosion Block is the recommended product, WD-40 Long-Term Corrosion Inhibitor may be used. Regular WD-40 cannot be used as it does not contain all the protective ingredients of the Long-Term Corrosion Inhibitor.)

Avoid getting Corrosion Block on other, non-metal surfaces, particularly vinyl seats or soft-grip flooring. If this occurs, clean immediately as directed by the product's directions to avoid stains that are also not covered under warranty.

NOTICE

Failure to use Corrosion Block as directed on the product label will result in the nullification of the Axis warranty in instances of corrosion damage. Failure to clean Corrosion Block off non-metal surfaces can result in damage that is not covered under warranty.

NOTICE

Axis uses only marine-rated and marine-grade fasteners on all models. If, at any time, it is necessary to replace any fasteners, seek guidance from an authorized Axis dealer to ensure that such replacements meet the requirements for operation in a marine environment.

To properly protect and ensure long life for vulnerable components, following the operation in salt or brackish water, provide extra attention to the cleaning process.



! WARNING

Boats operated in salt water, brackish water or polluted fresh water must be thoroughly rinsed with CLEAN, fresh water after EACH outing. The corrosive properties of these types of water will cause damage that is not covered under warranty! Hardware—even hardware chosen for its anti-corrosive properties—that is damaged by salt/brackish/polluted water may eventually fail, which could result in serious injury or death to persons onboard.



You will need microfiber towels and WD-40 Long-Term Corrosion Inhibitor or Corrosion Block.

The following areas, where equipped, should always receive special attention when cleaning after boating in salt/brackish/polluted water:

Bow area: bow grab handles, front cup holders.

Helm: windshield bracket, throttle, subwoofer plate, and the driver seat mount.

Lounge: cup holders, center plate, grab handles, ski pylon, and tower release hinges (varies by tower).

Exterior: front cleat, front ballast drain, navigation light, middle cleat, wakeboard tow mount, rub rail, rear cleat, rear ballast drain, rear cup holders, rear lifting eyes, Surf Gate logo, blower plate, tower speaker mounts, docking lights, front ladder (where equipped), and board racks.

Under the swim board: Surf Gate mounts, rudder, swim board mounts, powered swim step mounts (where equipped), propeller, underwater lights, strut, surf pipe exhaust, driveshaft, Power Wedge, and the thruster.

Other components requiring extra attention: Any metal seacocks or ball valves, any stainless steel or aluminum screws, stainless steel hose clamps, gas shocks, hinges, tracking fins, buss bars, power terminals, trailer tongue assembly, helm seat slides, starter, engine mounts, alternator, transmission coupler, Bimini metal moving parts, trailer swing-tongue pin, and the underside of the trailer.

Also treat exposed metal inside the engine compartment, paying close attention to the engine and transmission mounts, and all exposed metal hardware. Even though this area of the boat is not directly exposed to water, there is enough salt in the ambient atmosphere to cause corrosion. Therefore, Corrosion Block should be sprayed on a cloth and then applied to these areas at least once a month.

Be especially careful to avoid getting Corrosion Block on the areas of the pulleys that make contact with the belt. Corrosion Block could cause belt slippage.

Examine all metal components on the boat trailer for signs of corrosion. Corrosion Block should be used on metal trailer parts, too, paying attention to components that become submerged during boat launching and loading. Avoid the brake components (rotors, calipers, and pads).

Examine the sacrificial zinc anodes. Your authorized Axis dealer can offer guidance regarding the appropriate reduction rate, as well as the time at which anodes need to be replaced. Please note that because this is a natural function of operating in certain bodies of water, the cost of replacement is not covered under warranty.



Flush Kit

The flush kit is used to clean out the raw water pickup and operational areas of the engine. The kit attachment is located on the port side of the transom.

Before beginning this procedure if the boat is in water, be sure the raw water pickup under the boat is closed. If it is not and the boat is in water, raw water will become mixed with the clean water and will diminish the cleaning process.

Open the fixture by twisting the cap counterclockwise. The cap is attached to the fixture by a chain. Attach a garden hose with a fresh water source (without water running) to the fixture. When it is secured, fully turn on the hose (less water flow will be inadequate to flush the system and could result in damage to the system that is not covered under



warranty). Water will flow through the water pickup.

Turn the engine on to move water through the system. At no time should you ever exceed 1,100 rpm. The water flow is insufficient to cool the engine via the flush kit if the rpm exceeds 1,100. Water will exit through the surf pipe in approximately 20 seconds while reducing the flow out the pickup.

Run clean water through the system for approximately 8-10 minutes.

After running clean water through the system as prescribed, turn the engine off. Turn off the water source for the hose. Disconnect the hose and reinstall the cap securely on the flush kit connector at the transom. If the cap is not secure, air will be introduced into the system that will adversely affect the boat's cooling system.

Before boating again, be sure the raw water pickup is opened.

NOTICE

Inspect that the flush cap is tight before every outing or it will suck air and could damage the cooling system. Such damage is not covered under warranty.

Corrosion in Fresh Water

The immediate previous information covers care and maintenance in salt or brackish water conditions. However, it has been demonstrated that corrosion can occur in any water. As noted at the beginning of the *Care and Maintenance* section, keeping your boat and trailer clean—and dry, when not boating—is critical to a satisfactory experience. Corrosion can occur in any humid atmosphere. Even when boating in clean water, part of the care and maintenance should include regularly reviewing all metal areas on the boat and trailer for signs of corrosion. Any sign of corrosion requires immediate attention. Corroded components must be treated and/or replaced to avoid further corrosion. Note that corrosion is not covered under warranty.

WARNING

Corrosion can occur to any metal component of the boat and/or trailer if care is not taken to keep such components clean and dry when not boating. Such corrosion is not covered under warranty. Deterioration of components due to corrosion can result in component failure, which can lead to serious injury or death.

ROUTINE MAINTENANCE

Attention to the mechanical components of the boat is as critical as any matter in ensuring a long, enjoyable ownership. Some boat maintenance is required prior to and following every outing, some must be done on a regular schedule, and some must be done in accordance with proper storage and winterization. Because of the complexity of some components, such as the fuel system, you will need to seek assistance from an authorized Axis dealer's service department. Other issues can be easily accomplished by the boat operator.

The following engine and drivetrain-related information appearing in this section of the manual is intended for Axis-built engines and drivetrains. The instructions must be followed in order to keep the warranty in effect.

Note that these instructions should be followed even after the warranty period has expired. The instructions developed for the powertrains and drivetrains in Axis boats function as the guidelines to a long-term, positive boating experience.

CAUTION

Failure to follow the care and maintenance instructions as provided in this section of the Owner's Manual can result in damage to the engine and transmission that is not covered under warranty. The rest of the care and maintenance information provided for the boat is also critical to long-term success in boat operations. Under some circumstances, failure to follow the instructions, especially as noted on a timely basis, could result in the boat becoming inoperable, stranding boaters and/or placing those onboard in situations that could result in difficult situations.

The following engine-related information is provided for the Monsoon Engines. Unless otherwise directed, the instructions are applicable to all engines. Detailed information follows this section.



Before Starting the Engine:

- Check coolant level.
- Inspect the sea strainer.
- Check the engine oil level.
- Check the battery holders and the connections.
- Check for odors, particularly fuel odors.

After Starting the Engine:

- Check for odors, particularly from exhaust emissions.
- Be certain that the battery registers as fully charged and that there is enough fuel for the outing.

After the Outing:

- Give the engine compartment a general inspection.
- Check the other components.
- Note how much fuel was used and the state of charge on the batteries.
- Give the boat a good general cleaning as outlined in the *Ongoing Care* information that precedes this section.

After 10 Hours on the Hourmeter:

- Check the safety equipment.
- Have the oil changed by an authorized Axis dealer. The dealership will also do several other critical inspections of the drivetrain.

After 50 Hours or Annually (whichever comes first):

- There are certain maintenance routines that must be performed. Due to the complexity of this maintenance, Axis recommends it be completed by your authorized Axis dealer.

Storage and Winterization (details follow):

This is critical to the life of the boat. These steps include ensuring that all water has been evacuated from the boat, the battery is properly stored, and the boat finishes are protected. Information is also provided regarding the proper lifting of the boat from the water if it will be stored at any time by that method instead of resting on a custom-built Axis trailer.

NOTICE

Failure to follow the maintenance instructions provided in this manual will result in the voiding of the Limited Warranty explained in its own section of this manual.

BEFORE STARTING THE ENGINE

! DANGER

Before starting the engine, run the bilge blower for about four (4) minutes with the engine compartment open, to ensure the fuel vapor is dissipated prior to operation.

Check Coolant Level

Be certain the emergency safety stop switch is disconnected, and the shifter/throttle is in neutral. Open the engine compartment hatch and locate the coolant reservoir. The reservoir will be located on the port side of the engine between the manifold and the intake diagonally behind the alternator. The reservoir features a FULL marking.

This is not the same as filling the reservoir until it is completely full. The reservoir requires expansion room while in operation; therefore, the full marking is slightly lower than the top of the tank.

! WARNING

Never open the coolant reservoir when the engine has been running. This check should be done prior to starting the engine. During operation, pressure builds up in the reservoir. Opening it before the cooling system has had time for pressure relief likely will result in an eruption of fluid. It will also be sufficiently hot to seriously burn skin. Always allow sufficient time for the fluid to cool and return to pre-operation levels.

It may be necessary to periodically add coolant as a small amount of evaporation occurs naturally. When adding coolant, use only a 5-year, extended warranty antifreeze (propylene glycol), either a premixed 50/50 mix or create a mix of 50 percent extended warranty antifreeze plus 50 percent distilled water. (Do not use tap or other water as



other elements in the water can cause build ups or deposits within the closed cooling system. This can interfere with proper operation and resulting damage is not covered under warranty.) **The coolant must be propylene glycol coolant only. Never use ethylene glycol or Dex-Cool, nor ever attempt to mix coolants as they will not properly mix. Use of unapproved coolant will void the warranty.**

Inspect the Sea Strainer

Raw water from the body of water is drawn into the boat as part of the cooling system for the engine and drivetrain. Even with the closed cooling systems, it is necessary to circulate additional water as part of an effective cooling system. To protect the system, a sea strainer is installed near the raw water intake, located at the transom next to the steering tiller arm. The sea strainer serves the purpose of keeping debris from entering the raw water-cooling system and causing eventual engine failure. As with any kind of strainer, it is necessary to regularly clean it so that water can flow unimpeded.

When operating the boat in water that is brackish or has a noticeable degree of weeds and other flora, it may be necessary to clean out the strainer in boats equipped with sea strainers even during an outing. Pay close attention to the engine temperature, which appears on the video screen. (See the *Dashes and Video Screens* sections of this manual for more information.) An overheating engine is probably due to inadequate water flow.

NOTICE

Continuing to operate a boat that is overheating the engine and drivetrain will result in engine failure eventually. Boat operators should routinely review the engine temperature information provided on the video screen on the instrument panel. Ignoring or failing to take proper steps to reduce the engine temperature, resulting in damage, is not covered under the warranty.

Leave the engine off.

To inspect the sea strainer, open the engine compartment. Note the sea strainer's appearance as shown in the photo on the right. (If you cannot locate the sea strainer, ask for assistance from your authorized Axis dealer.) This step is critical and cannot be overlooked.

Open and lift the cover to expose the filter.

Remove the filter and examine for any debris that has accumulated within it. When necessary, clean out the filter and then reinstall it in the housing. Hand tighten the lid so that water will not leak out and into the engine compartment.



If it is necessary to check the sea strainer during an outing, turn off the engine first and then close the valve on the water pickup feeding the sea strainer. Make sure you open the valve prior to running the engine; otherwise, it will overheat. Whenever the engine is running, water is being drawn in and you will not be able to inspect the sea strainer.

Check the Engine Oil Level

With the engine off, remove the engine oil dipstick from the top side of the engine.

With a clean, dry cloth, wipe the dipstick free of residual oil and reinsert it into the engine.

Withdraw the dipstick and note where the measurement reaches on the dipstick.

If the engine oil level is at or below the fill line, add new oil as described in the *Oil Change* information in this section of the manual. Never reuse oil or overfill as either can damage the engine, and it is not covered under warranty. Use only the oil specified for your installed engine.

Check the Battery Holders and the Connections

Because batteries contain fluid that is caustic and potentially dangerous to skin and body parts, boat operators need to ensure that the batteries are securely in place. Also, if the connections are loose, erroneous readings may be sent



to the boat system, which can cause running and functionality problems. To avoid becoming stranded during an outing, it is important to have accurate voltage readings throughout the time the boat is in use.

To check the batteries, be sure the engine is off.

Locate the batteries. While they may be in different places depending on the boat model, usually they are found under a bow seat. Check your *Quick Reference Guide* in this manual to determine the location.

- If the posts show signs of corrosion or other debris, remove the battery and clean carefully. To do so, follow these steps.
- Turn the engine off, as well as any systems that are operating on the boat.
- Make sure the battery switch is in the off position.
- Loosen and remove the negative (-) black terminal connection first. If you are using a wrench for this process, be careful to avoid touching the positive (+) red terminal connection as you may receive an electrical shock as a result.
- Next, loosen and remove the positive (+) red terminal connection.
- Disconnect the hold downs that are holding the battery in place.
- Remove the battery.
- Using a battery terminal cleaner, carefully clean the corrosion/debris from the battery posts.
- Using a baking soda and water mix, clean the battery case, taking care to avoid splashing any of the solution inside the battery vents. Rinse with clear water again, avoiding the vents.

 **CAUTION**

Inside the battery is an electrolyte fluid that allows the chemical reaction to provide power. The fluid is comprised of several components, one of which is sulfuric acid. As with most acids, this is caustic and corrosive. If it comes in contact with skin, immediately flush the area with copious amounts of fresh, clean water. Follow up with medical assistance.

- A battery terminal brush may be necessary to remove corrosion from the inside of the battery terminals. Use the same type of baking soda and water mix and rinse with fresh water. Dry with a clean rag.
- Check the box in which the battery is held to be certain that it is not showing signs of corrosion or dirt. Clean, if necessary, as with the above instructions for cleaning the battery. Be sure that the holding box is dry prior to reinstalling the battery.
- Repeat the steps with the second battery.
- After placing the battery back in the holding box, reconnect the hold down. Then reconnect the positive (+) red battery cable connection first. Follow with the negative (-) black battery cable connection.
- Tighten both terminals and then coat with a thin covering of marine dielectric grease. Be sure that the positive terminal rubber boot completely covers the terminal.

 **DANGER**

If it becomes necessary to re-charge a battery from an external source, **DO NOT** attempt to charge using automotive battery cables or use another boat battery as the source for charging. Some amounts of hydrogen gas are emitted during the charging process. This can be very dangerous. It is critical to keep all sparks, including smoking cigarettes, lighters, or any type of flame, well away from a charging battery. Use the optional battery charger sold by authorized Axis dealers, or a similar aftermarket battery charger. Using the wrong type of charging procedure or improperly charging a battery can result in an explosion and/or fire that could lead to serious injury or death.

Check for Odors

An unexpected or strong odor can be the first sign of leakage. Both exhaust and fuel leaks have distinctive odors and should never be ignored. If either is present, do not start the engine until the source of the odor has been determined and corrected.

 **DANGER**

Because gasoline is highly flammable and vapors are more dangerous than the actual liquid fuel, never introduce flame, spark, or electrical ignition into an unknown source of a fuel emission or leak. Always verify the source of and correct any leakages prior to use of the boat.



Check Flush Kit Cap

NOTICE

Inspect that the flush cap is tight before every outing or it will suck air and could damage the cooling system. Such damage is not covered under warranty.

AFTER STARTING THE ENGINE

Check for Odors, Particularly from Exhaust Emissions

As before starting, an unexpected or strong odor can be the first sign of leakage. Both exhaust and fuel leaks have distinctive odors and should never be ignored. If either is present, do not start the engine until the source of the odor has been determined and corrected.

DANGER

Because gasoline is highly flammable and vapors are more dangerous than the actual liquid fuel, never introduce flame, spark or electrical ignition into an unknown source of a fuel emission or leak. Always verify the source of and correct any leakages prior to use of the boat.

Be Certain the Battery Registers as Fully Charged and there is Sufficient Fuel for the Outing

Battery voltage and fuel levels are registered on the video screen. (See the *Dashes and Video Screens* section of this manual for details.)

In verifying the battery charge, look for a reading around 13 volts, but no lower than 10.5 volts or higher than 16 volts. Erratic readings are usually a sign of low voltage or loose connection(s). Even if the reading appears correct, if there were any symptoms of voltage insufficiency or error during a previous outing, check with an authorized Axis dealer before undertaking another outing. You do not want to become stranded with a dead battery away from the dock.

The current boat models are equipped with a low voltage alarm. Even with a fully charged battery onboard, it is possible to discharge so much that the boat becomes disabled. If running the stereo components with the engine off, periodically check the voltage reading to ascertain how much has been discharged. To avoid difficulties in restarting the engine, the system will shut off the stereo and sound an alarm if the voltage level falls below 10.5 volts. The alarm will continue for approximately two (2) minutes to allow everyone out of the water around the transom, and the boat operator to restart the engine to allow the engine alternator to recharge the battery.

The engine will not start if the battery cables are not secure on the battery posts. Check this first. If the cables are tight on the battery posts and the engine still will not start, the battery may need an assist from an approved battery charger.

As noted above, do not attempt to jump-start a dead battery. This is not only dangerous but puts undue stress on the boat engine's alternator, which may cause it to fail. This is not covered under warranty.

NOTICE

Attaching the wrong battery cable or using jumper cables can result in damage to electrical components on the boat. Such damage is not covered under warranty.

Fuel levels should be noted prior to an outing. Axis recommends starting all outings with a full tank and returning to shore to refuel whenever the fuel readings drop into the one-quarter (1/4) range as falling lower can result in engine issues. (See *Fueling* information in the *Engine* section of this manual.) Failure to pay attention to the fuel level can result in the boat's fuel pump failing to maintain its prime or running out of fuel and leaving the boat stranded. Axis does not pay for towing.

AFTER THE OUTING

Give the Engine Compartment a General Inspection

Look for signs of leaks or anything abnormal. It's a simple thing, but often the simplest, quick look can pinpoint an issue before it becomes a problem.



Check the Other Components

This is a common sense approach. If you've been boating in dirty water, cleaning out the sea strainer now instead of waiting until the debris inside it has dried (and therefore becomes more difficult to remove) makes sense. You want to check the rudder, propeller, and driveshaft to make sure they appear intact, too, especially if you suspect that you may have struck something submerged during the outing. These are easy checks after the boat has been loaded on the trailer and removed from the water.

Check anything else on the boat that did not function as expected during the outing and seek assistance from your authorized Axis dealer about any concerns and issues prior to the next outing.

Axis recommends keeping a chart or binder with information from your outing. If you note the conditions during the outing, the length of time, and the final readings, you'll have a much better idea of normal operations. That gives you the clues you need when readings are different, or you are anticipating an outing that will be different and you need to prepare for those conditions.

Give the Boat a Good General Cleaning

(Outlined in the Ongoing Care information that precedes this section)

As noted earlier, ongoing care is important. Read that section to determine the normal expectations regarding routine care. Read the Saltwater Series maintenance information that appears earlier in this chapter. Even boating in "clean" water, you add protection and quality care for your boat by following the cleaning requirements. The same components that need added protection from salt/brackish water will also retain their luster and live longer if the same attention is applied to them.

AFTER 10 HOURS ON THE HOURMETER HAVE THE ENGINE OIL CHANGED BY AN AUTHORIZED AXIS DEALER

Do not do your first oil change before 10 hours or later than 15 hours.

The boat must be returned to an authorized Axis dealer for the first service/scheduled maintenance. The purpose is to allow a trained technician to interpret any signs of malfunction or anomaly that may have occurred. Catching these symptoms early is critical to avoiding potentially damaging events that might not be covered under warranty.

The dealer will change oil, transmission fluid, inspect the cooling fluid, clean the sea strainer, inspect the air filter, check the heat exchanger, and perform an alignment check on the engine among a variety of checks and inspections that will yield diagnostic clues to how well the engine and drivetrain are performing during the break-in period.

Check the Safety Equipment

If you have not done so previously, check the fire extinguishers and personal flotation devices. Check the condition of (and replace as necessary) drain plugs, bilge pumps, and exhaust flaps. Repair or replace anything that appears damaged or incapable of performing its function.

AFTER 50 HOURS OR ANNUALLY (whichever comes first)

There are certain maintenance routines that must be performed. Due to the complexity of this maintenance, Axis recommends it be completed by your authorized Axis dealer.

Your dealer will verify many functions of the boat for you, some of which should never be tested or checked by the consumer, such as the pressurized fuel system that requires unique tools.

Even when an authorized Axis dealer performs the annual maintenance work, consumers are well advised to pay attention to several components on the boat. These include:

Engine Mounts and Engine Alignment/Propeller

Your engine is held firmly in place by special marine-grade engine mounts that are built and installed to withstand the kinds of stresses unique to a boating environment. Drivetrain alignment is critical to providing a reliable on-water experience. At any time during operation, regardless of the amount of time on the hourmeter, if there is



excessive vibration, the boat should be presented to an authorized Axis dealer to check the alignment.

Note that vibrations can also be caused by a dented or bent propeller, loose propeller or propeller nut. Debris/plant material/ropes wrapped around the propeller shaft can also cause vibrations. Check the propeller for damage.

Continued operation could result in damage to the drivetrain that is not covered under warranty. Not every vibration is the result of misalignment, which can occur even during normal operation, but all vibrations should be checked by an authorized Monsoon Engine dealer to confirm or rule out the alignment as the cause.

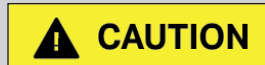

Vibrations are a symptom of a concerning issue involving your boat. When a vibration is detected, the boat needs to be analyzed, particularly the engine and drivetrain alignment. Misalignment can cause significant damage to the drivetrain, and such damage is not covered under warranty.

In checking the engine mounts, be sure to do this before starting the engine. Components on the engine can become hot enough to burn skin. Avoid this by checking before starting.

NOTICE

Any time you suspect an engine mount is loose, it must be tightened. Allowing the engine to shake or move during operation, adversely affects the entire drivetrain and could cause damage that would not be covered under warranty.

Steering System

Axis offers two types of steering systems, a standard, manual system, and an optional hydraulic system. The latter is pressurized, and the consumer cannot access or alter the system, nor should they try.

Shifter/Throttle

As with the steering, never ignore suspicious issues with the shifter/throttle. Anytime the lever does not move smoothly, or the boat does not shift/accelerate/decelerate with ease and smoothness, it is a matter to be resolved by an authorized Axis dealer. Do not wait for the annual maintenance period to verify safe operations.

Battery

Verify that battery cables are tight and securely attached to the battery terminals.

Your authorized Axis dealer can check to see that the battery(ies) appear to be holding charge properly. Unless a battery has fully expended its life cycle, it's impossible to guarantee that the battery will continue to serve, but experience helps the dealer to anticipate whether there is still service to be expected from the battery.

When it is necessary to replace a battery, be certain to select a marine-grade battery with at least eight hundred (800) cold cranking amps (cca) at zero degrees Fahrenheit. Spiral cell batteries are superior in holding charges and extending the period of available usage.

Considerably more information about batteries is available in the *Dashes and Video Screens* section of this manual.

Refer to your battery supplier for advice regarding long-term storage and/or winterization. If your battery manufacturer recommends removing the battery(ies) from the boat, verify whether the manufacturer requires that the battery(ies) is/are fully charged.



Follow common sense safety instructions regarding the removal or installation of batteries. Due to potentially explosive fumes and corrosive battery acid, failure to wear protective items and follow instructions correctly could result in serious injury or even death.

- Because of corrosive and explosive qualities in battery acid and fumes, put on safety glasses and mechanic-type safety gloves.
- Determine the size socket required to disconnect the battery cables and bracket nuts. Extensions may be required.
- **ALWAYS DISCONNECT THE NEGATIVE (-) CABLE FIRST.**
- Ensure that the negative cable will not come in contact with the positive (+) cable during the rest of the procedure.
- Disconnect the positive (+) cable, **TAKING CARE TO AVOID ANY CONTACT BETWEEN THE POSITIVE BATTERY CABLE AND ANY METAL.** There may be residual charge still in the electrical system, which could result in a serious electrical shock or burns.
- Batteries should always be stored in a cool, dry location. Manufacturers generally prefer batteries be stored on shelving above floor level.



- Using an old toothbrush or similarly bristled brush, and a mix of baking soda and water, clean off the battery terminals and cable ends, if they show any signs of corrosion. A small amount, especially as batteries age, is not uncommon, but excessive corrosion could be a sign of future service interruptions, and it should be brought to the attention of your authorized Axis dealer. Allow the terminals and cable ends to air dry.
- Clean the battery lugs with a wire brush.

Following the storage period, reverse the above steps to reinstall the battery(ies).

Pumps

The authorized Axis dealer can inspect and repair/replace ballast and bilge pumps that are not functioning properly. This is both a safety matter and adds to the life of the boat's systems. All pumps will lose functionality over time as the internal components are designed to be self-sacrificing during use, rather than allowing debris to foul and damage more expensive and complex components of these systems. Insist upon pump evaluations during annual maintenance.

Coolant System

There are two elements to the coolant system in Axis boats: the closed-cooling system and the raw water intake system. Both require attention on a regular basis. Depending on the body of water, attention may need to be frequent.

Instructions for inspecting and cleaning the sea strainer (raw water intake) are provided above, under *Before the Outing*.

The following information concerns the closed cooling system, which should be checked at least annually, even if there have been no instances of overheating during outings.



NOTICE

Any time the engine temperature rises above normal operating levels (approximately 155-175 degrees) operators must determine the source of the overheating and address the issue. Often, it may be caused by debris in the sea strainer (raw water intake). If cleaning the sea strainer does not result in lower operating engine temperature, have the boat towed to shore and take it to an authorized Axis dealer for analysis. Failure to immediately address overheating issues can void the warranty.

The closed cooling operates on a 50/50 mix of marine-grade coolant (propylene glycol) such as Peak Sierra brand and clean, distilled water. (Some brands sell coolant conveniently pre-mixed. Be sure to read the label carefully, and do not add any water to coolants that are pre-mixed. This will dilute them to unacceptable levels of mixture.) When mixing coolant and distilled water, do so in a clean container. Dirt, oil, or other contaminants can cause damage to the cooling system, which may not be covered under warranty.

In the LT4 engine, check both cooling containment units.

The coolant should be inspected after the first 25 hours and annually. It should be changed every two (2) years, or if the propylene glycol does not meet the minimum freezing requirements for a given area when tested with a refractometer, test strips, or ball tester.

Oil System

Replacing the oil filter and oil is an important part of the annual maintenance. Due to



environmental concerns, Axis recommends having an authorized Axis dealer complete this important function. For those who feel confident they can complete this maintenance step with guidance, the following steps must be followed.

Have nine quarts of 5W30 synthetic engine oil available for the 5.3L or 6.2L M-Series engines, and nine quarts of 0W40 full synthetic dexos™gen2 oil for LT4 engines. The use of any other oil or fluid may void the warranty. Axis boats offers a full synthetic oil blended specifically for Axis engines. For more information about purchasing this oil for use in your boat, contact your authorized Axis dealer.

Whenever possible, run the boat for approximately five (5) minutes on the water. This will heat up the oil to a better viscosity for draining.





Draining the Oil:

- Have a drain pan or container ready. Never pour used oil on the ground or into the water. This is illegal in most instances and has a negative environmental impact. The oil drain line is located on the side of the engine oil pan through a fitting, and it is approximately four (4) feet long.
- If a siphon pump is not available for use in this process, run the drain hose through the transom drain plug location (with the boat out of the water; removing the transom drain plug while in the water could result in the boat taking on water and sinking). Because the line will not feed through the drain plug with the line cap on, raise the line above the oil pan. This creates a P-Trap as the end of the drain hose is fed through the transom drain plug to allow the gravitational flow of used oil.
- If a siphon pump is available, remove the drain line cap, create a seal on the siphon hose and start the pump. About eight-to-nine (8-9) quarts of used oil should drain into the catch container. Typically, engines burn a small amount of oil during operation. An authorized Axis dealer technician can advise you whether you should be concerned about the amount of oil used between oil changes.

Replacing the Oil Filter:

- Oil filters are located on the front of the engine.
- Remove the oil filter housing cap.
- Use a tool designed for removal or installation of oil filters only. Other tools may crush the filter and release used oil into the engine compartment, the boat or the work area. Remove the cap by turning counterclockwise and replace by turning in the opposite direction. Never force the oil filter housing cap. It should be on the engine securely, but it should release with only hand force when using tools. Some small amount of residual used oil may be inside the filter. Keep a shop rag or similar catch under the filter as it is removed from the boat.
- Some mechanics choose to inspect the oil filter to examine for any evidence of metal shavings or other unwanted signs of engine wear. If you choose to do so, be sure to do so over a container. Clean up any oil that ends up spilled.
- Also examine the O-ring on the cap. If it is damaged, it should be replaced.
- Secure the oil filter housing cap in place on the engine. Tighten securely by hand, but do not force the filter as it may damage or break the seal if over-tightened.



Adding New Oil:

- Replace the drain line cap on the drain line and thread the drain line back to adjacent to the oil pan.
- Remove the oil fill cap on top of the valve cover.
- Place a clean funnel within the oil fill cap.
- Pour approximately eight (8) quarts of oil in the engine through the funnel, allowing time for the fill to occur. (Having nine [9] quarts on hand allows you to top off as needed as the system could hold this much with all lines filled). As you approach the eighth quart, slow down (it takes a little time for the oil to move through the oil system) and start watching the fill line on the dipstick. Always clean the dipstick between readings to ensure accuracy.
- **Stop filling oil into the system when you reach the FULL mark on the dipstick, regardless of how much oil has been added. Over-filling can damage the system. NEVER REUSE OIL. ONLY NEW OIL SHOULD BE USED. ONLY 5W30 SYNTHETIC DEXOS™ GEN2 ENGINE OIL SHOULD BE ADDED TO THE OIL SYSTEM OF AN M-SERIES ENGINE AND 0W40 FOR AN LT4 ENGINE.**

Transmission/V-Drive System

Transmission fluid checks must be done **ONLY** when the transmission fluid is heated. Therefore, the boat should be run in a body of water for at least five (5) minutes, and then shut down.

- Remove and wipe down the transmission dipstick.
- Reinsert, but **DO NOT SCREW DOWN FLUSH WITH THE HOUSING AS THIS WILL CAUSE AN ERRONEOUS READING.** Check the level.
- Transmissions should register approximately two-and-a-half (2.5) quarts of automatic transmission fluid.
- V-drive boats: Remove the stick, wipe down, reinsert unseated. Remove and check the level.
- V-drives should have one-and-a-quarter (1.25) quarts of **Mobil SHC 630 Gear and Bearing Oil.**
- If the ATF fluid and Mobil SHC 630 Gear and Bearing Oil appear clear, add the specified fluid only to the full line. **DO NOT** add any fluid other than the specified fluid as it can damage



the system and void the warranty. **OVERFILLING CAN DAMAGE THE SYSTEM.**

- Even if the fluids appear clear, replace transmission fluid annually, and V-drive fluids every 1200 hours or every three (3) years, whichever occurs first.

Fuel System

This is important. Debris and water may enter the fuel system, even with the careful protection built into the system. Periodic replacement of the fuel filter is required to protect the fuel pump and provide the proper fuel pressure to the engine. Due to the need to use only specialized tools that are not available to the public, and because the fuel lines are pressurized, no fuel system maintenance can be completed by a consumer. One fuel filter is located within the fuel tank. Even though it is more accessible, because it is under pressure this also is restricted to replacement by an authorized Axis dealer.

While some boat owners may not have a dealer close at hand, this maintenance needs to be completed only by trained technicians with the appropriate, specialized tools. We apologize for any inconvenience.

An annual replacement is recommended for both filters.

Hydraulic Steering System

The steering in Axis boats may feature a hydraulic system that can be maintained or repaired only with specialized tools. Because of the potential for physical harm when working on this system, it cannot be checked, changed or repaired by consumers. Only an authorized Axis dealer has access to the tools and system.

Safety Equipment

If you have not done so previously, check the fire extinguishers and personal flotation devices. Check the condition of (and replace as necessary) drain plugs, bilge pumps, and exhaust flaps. Repair or replace anything that appears damaged or incapable of performing its function.

Power Wedge III and Surf Gate Manual Extension and Retraction

For boats equipped with these features, it is important for the authorized Axis dealer to verify the manual extension and retraction function is operational, in case the consumer ever has to perform this due to the failure of the automated system controlled through the video screen.

For the Power Wedge III, using a small (stubby) straight screwdriver, loosen the small red screw on the actuator beneath the swim board until it stops. Lift or lower the wedge to the position desired and then tighten the screw snugly (but do not over-tighten). Manually cycle the wedge a couple of times after doing this to ensure that the screw is snug, and the wedge moves correctly.

For the Surf Gate, there is a red hex bolt on the side of the actuator. Opening this valve with a 3/8" wrench will allow the Surf Gate to be moved into a closed position. Be sure to re-tighten the bolt to prevent it from drifting open while operating the boat.



For Saltwater Boats

Perform the normal cleaning procedures described above in the salt water/brackish water maintenance information. Boats operated in salt/brackish/polluted water are especially vulnerable to accelerated wear and tear. Never ignore the care and maintenance required to keep your boat under warranty and in good condition for the life of the boat.

Because the process of preparing a boat for long-term storage (more than two weeks) and/or winterization is extremely important and takes some time to accomplish, this is often paired with the annual maintenance preparation. Regardless of timing, however, storage and winterization must never be overlooked, especially in climates where the temperature will fall below freezing.

If the boat will not be used for an extended period, regardless of season, or if the boat will be left in water fulltime during boating season, there are precautions which should be taken.



STORAGE AND WINTERIZATION

Hull Gel Coat

If a boat will be left in the water all the time during boating season, Axis recommends using a bottom, hull paint to protect it. Even with the highest grade of gel coat, continuous exposure to water, even fresh water, will eventually result in damage to the finish. Therefore, in these circumstances, boat owners must protect the finish with an approved hull paint. Your authorized Axis dealer can direct you to the correct paint and can complete the preparation for you.

NOTICE

Failure to protect the hull from excessive exposure to water or foul weather can result in damage to the hull paint and gel coat that is not covered under warranty.

Extended Non-Use

If a boat is not used for an extended period of time—**more than fourteen (14) days**—owners should remove the boat from the water if possible. Perform the expected storage preparations, including removal of all ballast water, water from the bilge area, and periodically check the battery status as certain automatic functions are performed even when the boat is out of the water and the battery switch is in the off position. It may be necessary to occasionally charge the battery. See information above and in the *Electrical Components* section of the *Dashes and Video Screens* chapter of this manual regarding battery maintenance and the proper way to ensure batteries remain charged.

Lifting the Boat

Many boat owners remove the boat from water by way of a trailer, which allows for transport as well as an excellent way to store the boat if the trailer was designed and built for that boat model. Incorrect fit means that there will be undue stress on the boat's structural unit. Over time, these components could potentially fail, which would not be covered under warranty.

However, some boaters, especially those who are privileged to live on a shoreline or due to the methods of extracting boats from specific bodies of water, must lift the boat to suspend the boat or use a boat cradle.

When the boat must be lifted, use the correct sling system or the lifting eyes only. Never allow a lifting device to wrap around the underwater gear as the weight of the boat could cause the sling to damage the gear. The boat may not be able to withstand the gravitational forces if the boat is not properly supported.

NOTICE

Never use the ski pylon or tower as part of the lifting process. These compartments are not designed to be utilized at any time or any point in the lifting process. Never use the cleats for lifting either. Never lift the boat with any water in the ballast or bilge systems of the boat. The additional weight could cause failure also.

When using the lifting eyes on the boat, an overhead hoist should be used to lift the boat, coupled with appropriately rated capacity straps. Each strap must be rated for the boat weight or higher. See the *Quick Reference Guide* in this manual to determine the boat's base weight, without any added gear. Spreader bars should also be used to prevent side loading of the stern eyes as well as damage to the rub rail on the bow. When lifting the boat, keep the bow slightly higher than the stern to avoid having any water run into the engine exhaust system.

When using slings, an appropriately rated capacity overhead hoist is required. Multiple slings at least six (6) inches by twenty (20) feet should be used. As with the lifting eye straps above, check the *Quick Reference Guide* in this manual to determine the boat's base weight, without any added gear. An eight-foot (8') spread bar on each sling will prevent side pressure to the deck or gunwale molding that can cause damage. Such damage is not covered under warranty.

A storage cradle must provide proper support to the boat, meaning the boat cannot be supported by resting the hull on the keel. There can be no gaps between the hull and the cradle supports. Support of at least five hundred (500) square inches is required on boats of less than twenty-five feet (25'), and at least six hundred (600) square inches on boats greater than twenty-five feet (25').



Protect all underwear gear protruding from the boat hull from damage. None of these components is rated to support any of the boat's weight.

Winterizing the Flush Kit

Begin by performing a normal flushing of the engine.

WITH THE BOAT OUT OF THE WATER:

- Locate the flush kit connector on the port side of the transom, above the swim platform.
- Connect a gardening-type hose as shown in the accompanying photo to the flush kit system at the connector and turn on the fresh water at the source.
- With the boat shifter in neutral, start the engine and allow it to idle. During the entire process, **DO NOT EXCEED 1,100 RPM** on the engine. The freshwater hose cannot provide sufficient water supply to adequately cool the engine at higher RPMs. Also, never take the boat out of neutral gear.
- After approximately two-to-three (2-3) minutes of flushing, shut off the engine.
- Turn off the freshwater supply.
- Disconnect the hose and reinstall the cap on the flush kit connector.



NOTICE

Inspect that the flush cap is tight before every outing or it will suck air and could damage the cooling system. Such damage is not covered under warranty.

Winterizing Procedure

After flushing the engine, remove the T-handle drain plug in the bilge compartment, and the engine drain plugs located on the V-drive under the coupler, bottom of the heat exchanger, and both manifolds.

- All drain plugs should be placed in a plastic bag and stored in a visible location so when recommissioning the boat, the plugs will not be overlooked.
- After flushing with fresh water, open all draincocks. Depending upon the model, there may be several.
- When the water has fully drained, close the draincocks and tape shut the water inlet on the bottom of the boat. Use low-tack type of tape to avoid damaging the finished on the inlet and surrounding metal and gel coat. The water pickup does not need to be taped.
- With the boat shifter in neutral, start the engine and allow it to idle. During the entire process, **DO NOT EXCEED 1,100 RPM** on the engine. The freshwater hose cannot provide sufficient water supply to adequately cool the engine at higher RPMs. Also, never take the boat out of neutral gear.
- Run until there is no longer water coming out. **DO NOT RUN THE ENGINE FOR MORE THAN 30 SECONDS!** This procedure allows any remaining water in the system to be forced out.
- Remove the tape from the raw water intake, and the garden hose from the valve.

Winterizing with the Boat in Water

- After the flushing process is complete, remove the adapter from the flush pump cap strap and insert the adapter into the flush pump valve.
- Using a piece of gardening type hose, place the male end of the hose into the flush kit fitting and place the other end into a container of the marine-grade, 50/50 mix of distilled water and propylene glycol coolant, if not using a pre-mix of the same.
- Open all petcocks and drain the engine block and water-cooled manifolds. If the petcocks are plugged, carefully unclog the openings. When all the water has drained out, close all petcocks, and replace any plugs that were removed.
- Start the engine and the pump will automatically pump the coolant from the bucket into the engine and manifolds. **DO NOT EXCEED 1,100 RPM.**
- When the bucket is empty, **IMMEDIATELY** shut down the engine.

NOTICE

Always pay attention to whether all water inlets and drains are open or closed. Failure to follow directions can result in too much water (which could result in sinking of the boat) or too little water (which could result in insufficient cooling, which could damage the drivetrain and is not covered under warranty)!



For Extended Storage and Winterization

There are multiple steps required to prevent damage to the boat when it will not be used for an extended period, especially during colder weather months. Axis recommends having an authorized Axis dealer execute the storage/winterization process, followed by recommissioning when ready to begin use.

For Monsoon engines, fill the fuel tank full. You will need to use a STA-BIL® gasoline stabilizer. **Reminder: Stabilizers work in fresh gasoline only.** Adding a stabilizer after storage during the recommissioning period will not eliminate the gumming or water separation that may have occurred. **Stabilizers are preventatives, not curatives.**



All gasoline stabilizers have a limited life. Be sure to review the requirements as stated on STA-BIL® packaging or seek assistance from your authorized Axis dealer in determining how long and under what conditions you can reasonably expect the STA-BIL® to serve as designed.

Gasoline should never be stored for a period to exceed six (6) months. If it is necessary to remove gasoline from the tank and dispose of it, be certain to do so in compliance with local, state, and federal environmental laws/rules/ordinances.

All water that can be removed from the boat must be. This includes water in the engine, ballast, and bilge areas. Water that is not removed may freeze. Expansion and contraction that takes place as a result will damage affected areas of the boat. Such damage is not covered under warranty. This damage can be extensive and very expensive to repair.

There are four (4) drain plugs on the Monsoon engine (see photo), in addition to the T-handle in the bilge compartment and the transom drain plug. **ALL PLUGS MUST BE REMOVED, AND ALL WATER DRAINED PRIOR TO STORAGE TO PREVENT POTENTIAL FREEZING AND DAMAGE TO THE ENGINE AND BOAT.**

The circulating hose on the starboard side and aft of the engine under the heat exchanger may or may not have a plug. If equipped with a plug simply remove it. If not, you must do the following: Loosen the clamps holding the hose in place and allow it to drop down to drain any residual water in the system. This is the lowest area of the circulating water system, and gravity should allow any water to drain that was not previously drained.

NOTE: When reconnecting this hose as the boat is recommissioned prior to operation, be sure to tighten the clamps holding this hose but **DO NOT OVERTIGHTEN.**

The clamps should be tight enough to prevent leaking, but over-tightening them will accelerate wear and tear on the hose and could eventually cause failure that is not covered under warranty.

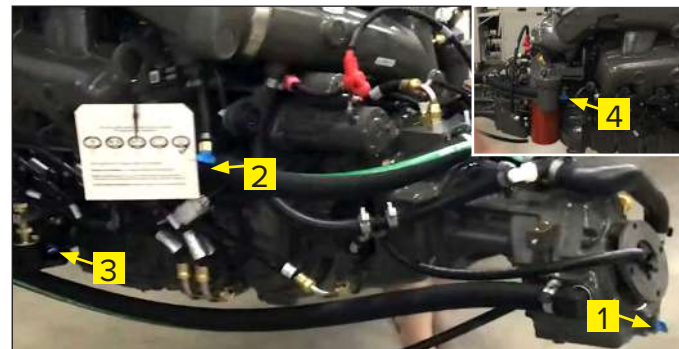

The engine drain plugs are located: 1. The V-Drive. 2. The bank 1 manifold. 3. Under the heat exchanger. 4. The bank 2 manifold.

NOTICE

All drain plugs in the boat, regardless of the engine manufacturer, must be removed and all water drained prior to storage, particularly during winter months, to avoid potential freezing and damage to the engine and the boat. Such damage is not covered under warranty.

The electric valves (not visible) need to be opened to let water escape to avoid freezing that could crack the valves. To complete:

- With the boat out of the water, turn the ignition ON to control the process from the 12" display.
- On the Ballast page, press "FILL ALL."
- Allow the system to run for thirty (30) seconds. No longer, no shorter.



- Click “STOP ALL” at the conclusion of the thirty (30) seconds.
- The process allows any remaining water to be expunged.

If the batteries are removed for storage, they should be fully charged prior to removal. Batteries should be stored in cool (but not cold), dry locations. Never store batteries near heat devices or anything that causes a spark or electrical charge. Fully recharge the battery prior to reinstallation.

NOTE: If the battery is removed from the boat, the automatic bilge system will not operate, and water will not be discharged from the bilge. Therefore, boats that are stored in water must not have the batteries removed.

Additional Steps to Complete for Storage

- Drain any residual water from the plumbing.
- Thoroughly wash and clean the boat, inside and out, as instructed in the Ongoing Care section of this manual.
- Leave the bow slightly elevated so that any further draining of water from the bilge system will run out and not accumulate inside the bilge system.
- Remove the drain plug(s) and place them in see-through plastic sacks or containers. Place them inside the boat so that they will be immediately locatable for recommission.
- Using low-tack tape, tape around the exhaust flap (where equipped) so that vermin cannot chew their way into and nest inside the exhaust system.
- Apply wax to the entire exterior surface to protect the hull and deck finishes, particularly from dampness and condensation that may occur.
- Remove the propeller and store in a safe place.
- Remove the seat cushions and store in a cool, dry location. Open all storage compartments and areas to allow air circulation. Without it, mold and mildew may invade the compartments.
- Prop the engine compartment lid open several inches to allow for air circulation.
- If the boat will be outdoors, use an optional Axis canvas cover that has been sewn to fit the boat deck snugly and not allow intrusions of rain and/or snow.
- Check the trailer wheels if the boat is stored on a trailer.

WHEN RECOMMISSIONING THE BOAT FOR THE FOLLOWING BOATING SEASON, REVERSE THE ABOVE STEPS, PLUS ADD THE FOLLOWING:

- Check all fluids, oil, and coolant. Add, replace, or change as necessary.
- Check the engine for cracks and leaks that may have been caused by freezing temperatures and/or water.
- Check all hose clamps to be certain they are secure and that the rubber hoses have not deteriorated over the period.
- Reinstall the propeller if it was removed. Grease the shaft taper prior to reinstalling the propeller.
- Have the alignment between the output flange on the transmission and the propeller shaft flange checked. An authorized Axis dealer has the measurement detail for correct alignment.
- Prior to starting the engine in the water, key it on and off two or three times, allowing several seconds between key-on cycles, prior to cranking the engine to fully start. The purpose of this is to prime the fuel system. If the engine appears reluctant to start, allow a couple minutes of cool down for each attempt to crank and start the engine. Watch the video screen for readings and listen for abnormal sounds. Keep speeds low until the engine temperature rises to the normal operating temperature.

NOTICE

Failure to properly perform annual maintenance, plus storage/winterization procedures as described in this manual is likely to result in damage to the boat, components, drivetrain, and features. Such damage is not covered under warranty.



maintenance schedule

When reaching first 10 hours



Change

- Engine Oil and Filter**
- Transmission Oil



Inspect

- Sea Strainer#
- Engine Coolant
- Shaft Alignment

After every 50 hours



Change

- Engine Oil and Filter**
- Raw Water Impeller



Inspect

- Sea Strainer#

After every 150 hours



Change

- Engine Fuel Filter
- Fuel Pump Filter



Inspect

- Shaft Alignment

After every 300 hours



Change

- Serpentine Belt ##



Clean

- Spark Plugs

Annually



Change

- Engine Oil and Filter**
- Transmission Oil
- Air Filter



Inspect

- Sea Strainer#
- Engine Coolant
- Serpentine Belt
- Shaft Alignment
- Heat Exchanger



Replace

- Sacrificial Anodes

First of the Season



Change

- Raw Water Impeller

Every 2 Yrs



Change

- Engine Coolant
- Air Filter#
- Spark Plugs

Every 3 Yrs or 1200 Hrs (whichever comes first)



Change

- V-Drive Oil

***If the engine is subject to extreme use such as excessive ballast weight, long idle time, low use, elevations above 5,000 feet, or commercial use, it is recommended to change oil and filter every 25 hours.*

****First of the season*

Replace sooner if regular inspection indicates wear or damage

3 years or 1200 hours, whichever comes first

It is always recommended that these requirements be performed by an authorized Malibu dealer. Service technicians from Malibu dealerships have proper equipment, training, and resources to best meet the requirements. Please note that routine maintenance is not covered by the Malibu Boats Limited Warranty. For details, please consult the limited warranty statement.



warranty

AXIS WAKE RESEARCH LIMITED WARRANTY STATEMENT

Axis Wake Research, LLC Limited Warranty
(hereafter the “Limited Warranty”)

Section 1. Certain Limitations and Disclaimer of Implied Warranties

THE LIMITED WARRANTY SET FORTH HEREIN IS IN LIEU OF ALL OTHER WARRANTIES AND REPRESENTATIONS, EXPRESS OR IMPLIED, AND TO THE MAXIMUM EXTENT PERMITTED BY APPLICABLE LAW. AXIS WAKE RESEARCH, LLC DISCLAIMS, AND THE PURCHASER HEREBY EXPRESSLY WAIVES, ANY AND ALL OTHER WARRANTIES OR REPRESENTATIONS OF ANY KIND OR NATURE, INCLUDING, BUT NOT LIMITED TO, IMPLIED WARRANTIES OF MERCHANTABILITY AND FITNESS FOR A PARTICULAR PURPOSE, OTHER THAN THOSE WARRANTIES WHICH ARE IMPLIED BY, AND ARE INCAPABLE OF EXCLUSION, RESTRICTION OR MODIFICATION UNDER APPLICABLE LAW. THERE ARE NO WARRANTIES WHICH EXTEND BEYOND THE DESCRIPTION OF THE FACE HEREOF. ANY IMPLIED WARRANTY THAT IS FOUND TO ARISE BY STATE OR FEDERAL LAW, INCLUDING ANY IMPLIED WARRANTY OF MERCHANTABILITY OR ANY IMPLIED WARRANTY OF FITNESS, IS LIMITED IN DURATION TO THE DURATION SET FORTH IN THIS LIMITED WARRANTY OR THE DURATION SET FORTH BY APPLICABLE STATE OR FEDERAL LAW, WHICHEVER IS SHORTER.

PERFORMANCE OF REPAIRS AND NEEDED ADJUSTMENTS IS THE EXCLUSIVE REMEDY UNDER THIS LIMITED WARRANTY, WITHOUT EXCLUSION, MODIFICATION OR RESTRICTION, OTHER THAN UNDER APPLICABLE LAW. AXIS WAKE RESEARCH, LLC SHALL NOT BE LIABLE FOR INCIDENTAL OR CONSEQUENTIAL DAMAGES, SUCH AS, BUT NOT LIMITED TO, LOST WAGES, SLIP FEES, TRANSPORTATION TO OR FROM REPAIR, OR RENTAL EXPENSES, RESULTING FROM BREACH OF THIS WRITTEN WARRANTY OR ANY IMPLIED WARRANTY, OR OTHERWISE, EVEN IF AXIS WAKE RESEARCH, LLC HAS BEEN ADVISED OF OR SHOULD HAVE FORESEEN THE POSSIBILITY OF SUCH DAMAGES, AND EVEN IF ANY AXIS BOAT OR COMPONENT PART THEREOF FAILS OF ITS ESSENTIAL PURPOSE. THIS EXCLUSIVE REMEDY SHALL NOT BE DEEMED TO HAVE FAILED OF ITS ESSENTIAL PURPOSE AS LONG AS AXIS WAKE RESEARCH, LLC IS WILLING AND ABLE TO REPAIR OR REPLACE ANY DEFECTIVE GOODS SUBJECT TO THE TERMS PROVIDED HEREIN. UNDER ANY CIRCUMSTANCE, THE ENTIRE LIABILITY OF AXIS WAKE RESEARCH, LLC IS LIMITED TO THE LESSER OF THE REPAIR OR REPLACEMENT OF ANY DEFECTIVE COMPONENT OR AFFECTED PORTION OF THE AXIS BOAT, OR THE ACTUAL PRICE PAID FOR THE AXIS BOAT, MONSOON POWERTRAIN, AND/OR TRAILER.

SOME STATES DO NOT ALLOW LIMITATIONS ON TIME LIMITS OR EXCLUSIONS OF INCIDENTAL OR CONSEQUENTIAL DAMAGES, SO THE ABOVE LIMITATIONS MAY NOT APPLY TO YOU. THIS LIMITED WARRANTY GIVES YOU SPECIFIC LEGAL RIGHTS WHICH MAY VARY FROM STATE TO STATE, BY JURISDICTION, AND COUNTRY. TO THE EXTENT THAT YOUR STATE DOES NOT ALLOW ANY EXCLUSION OR LIMITATION EXPRESSED HEREIN, SUCH EXCLUSION OR LIMITATION WILL NOT APPLY TO YOU. ALL OTHER ALLOWABLE LIMITATIONS OR EXCLUSIONS SHALL APPLY TO YOU.

Section 2. The Limited Warranty Application and Terms; Transferability

Malibu Boats, LLC (“Malibu Boats”), of which Axis Wake Research (“Axis Boats”) is a subsidiary, warrants to the original user or purchaser, whoever comes first (hereafter the “Purchaser”), that each new and unused Axis boat, Monsoon powertrain manufactured by Malibu Boats and Axis Boats, where applicable (“Monsoon Powertrain”), and/or Axis trailer (“Axis Trailer”), shall under normal authorized use remain free from defects in craftsmanship and materials during the applicable warranty periods, in accordance with and subject to the terms, conditions and limitations as described in this Limited Warranty. Any and all references to Monsoon Powertrain within this document refer to only those powertrains, complete or component, which are manufactured by Malibu Boats and



Axis Boats. Axis Boats equipped with powertrains, complete or component, manufactured by outside suppliers are covered under, and subject to, limitations and time duration as described within the limited warranty statements provided by the supplier.

Subject to all other terms, conditions, and limitations, 1) original Purchaser(s) of the Axis Boat, Monsoon Powertrain and/or Axis Trailer and, 2) second owners of the Axis Boat and/or Axis Trailer who purchase the boat within five (5) years of the earlier of (a) the date the boat was purchased by the first retail purchaser through an authorized Axis Boats Sales facility, or (b) the date the boat was first put into service as a demonstrator or other use except for commercial purpose (from which there is no transferability of the limited warranty), and qualify for and complete a warranty transfer as explained below, are provided coverage under the Axis Boats Limited Warranty.

Note: This Limited Warranty is expressly conditioned upon the timely dealer’s completion of the warranty registration process to Malibu/Axis Boats. Although not obligated to and without creating such an obligation, this will enable Axis Boats to notify you of any necessary performance or safety modifications to your Axis Boat, Monsoon Powertrain and/or Axis Trailer and to verify ownership in case a warranty claim is filed on your Axis Boat, Powertrain and/or Axis Trailer.

The Limited Warranty is expressly subject to the following terms, conditions and limitations. All warranty applications are dependent upon the Purchaser following the guidelines established for appropriate and reasonable care and maintenance of the Axis Boat, Monsoon Powertrain and/or Axis Trailer and operating his or her Axis Boat, Monsoon Powertrain and/or operating the Axis Trailer reasonably and as directed in this Owner’s Manual, and as directed in any additional directions and/or owner’s manuals relating to any specific component part or parts of the Axis Boat, Monsoon Powertrain and/or Axis Trailer (the “Guidelines and Directions”). **Purchaser’s failure to follow such Guidelines and Directions shall void this Limited Warranty.**

All repairs performed by Axis Boats, or its authorized service facilities, will be performed using either new or re-manufactured parts. Axis Boats may, at its option, install parts which have substantially similar or greater performance characteristics if an identical replacement part is no longer available.

No person or entity is authorized to make any additional or revised statement or warranty, express or implied, on behalf of Axis Boats or any component supplier beyond what appears within this Limited Warranty.

Limited Warranty Summary:

Coverage Type	Coverage Period <small>(from date of original retail purchase or initial use of the Axis Boat, whichever first occurs)</small>
Structural Limited Warranty	Lifetime
Powertrain Limited Warranty	Earlier of Sixty (60) Months or 500 Hours
Trailer Limited Warranty	Sixty (60) Months
Base Limited Warranty - Fresh Water Boats	Sixty (60) Months
Base Limited Warranty - Salt Water Boats	Thirty-six (36) Months
Gel Coat & Powder Coat and Trailer Paint Limited Warranty	Twelve (12) Months

The repair and/or replacement of components or parts under warranty does not extend the warranty period beyond the original expiration date.

Section 2.1. Structural Limited Warranty.

For the life of the boat, Axis Boats will repair structural materials or structural workmanship supplied by it during the construction of the hull, deck, floor liner, or stringer, which are determined by Axis Boats to contain substantial manufacturing defects. This Structural Limited Warranty does not apply to the Axis Boat’s gel coat or powder coat (see below for *Gel Coat & Powder Coat Limited Warranty*), powertrain (see below for *Powertrain Limited Warranty*), trailer (see below for *Trailer Limited Warranty*) or any cosmetic aspects of the hull, deck, liner, or stringer. The entirety of the structural warranty is limited to the specific laminates or bonding of laminates for the hull, deck,

floor liner, or stringer only.

Section 2.2. Base Limited Warranty, Powertrain Warranty and Trailer Limited Warranty.

For a period of sixty (60) months or 500 hours, whichever is earlier, for fresh water boats and thirty-six (36) months for salt water boats, beginning on the date of the original retail purchase or the initial use of the Axis Boat, whichever occurs first, Axis Boats will repair or replace materials or workmanship supplied by it during construction of the Axis Boat, including parts and labor, which are determined by Axis Boats to contain substantial manufacturing defects.

For a period of sixty (60) months for powertrains manufactured by Malibu Boats/Axis Boats, beginning on the date of the original retail purchase or the initial use of the Axis Boat, whichever occurs first, Axis Boats will repair or replace materials or workmanship supplied by it during construction of the Monsoon Powertrain, including parts and labor, which are determined by Axis Boats to contain substantial manufacturing defects. Powertrains manufactured by suppliers and installed by Axis Boats will be subject to the limitations as described and provided by the supplier.

For a period of sixty (60) months for trailers, beginning on the date of the original retail purchase or the initial use of the Axis Trailer, whichever occurs first, Axis Boats will repair or replace materials or workmanship supplied by it during construction of the Axis Trailer, including parts and labor, which are determined by Axis Boats to contain substantial manufacturing defects.

This Limited Warranty does not provide coverage for any component part that is at any time covered by any warranty provided by any third party, other than Axis Boats, including, but not limited to the manufacturer of the component part. Component parts shall include, but are not necessarily limited to, any items that are fastened to the boat through either mechanical means (screws/bolts) or chemical means (adhesives), which may or not be manufactured by Malibu/Axis Boats. Some examples of component parts include gauges, carpet, floor panels, upholstery substrates and bases, brake actuator, brakes, axles, lights, spark plugs, filters, etc. In the event that any warranty coverage for any component part is rendered or deemed void due to actions of the Purchaser or any third party other than Malibu/Axis Boats, this Limited Warranty will not provide warranty coverage for the component part.

Towers are configured by Axis Boats for factory-installed components. The installation of any components onto the tower of any Axis Boat after it leaves Axis Boats' factory ("Non-Factory Tower Components") may require adjustments to the tower. Further, certain Non-Factory Tower Components may not be suitable to be installed on any Axis Boat's tower. If Axis Boats determines that any Non-Factory Tower Components have caused or contributed to the need for any repairs to the tower of an Axis Boat, or to any other aspect of an Axis Boat, Axis Boats, in its sole discretion, may deny coverage for such repairs. It is the sole and exclusive obligation of the Purchaser to verify and ensure that all Non-Factory Tower Components are suitable to be installed on any Axis Boat's tower, and that all Non-Factory Tower Components are properly installed on any Axis Boat's tower.

Section 2.3. Gel Coat, Powder Coat and Trailer Paint Limited Warranty.

Note: Minor distortions or imperfections resulting from the handcrafted application of the gel coat on an Axis Boat are considered normal and unavoidable. Gel coat, powder coat and trailer paint maintenance is the Purchaser's responsibility. Conditioned on the Purchaser having provided and performed all gel coat, powder coat and trailer paint maintenance and care described in this Owner's Manual, for a period of twelve (12) months, beginning on the date of the original retail purchase or the initial use of the Axis Boat and/or Axis Trailer, whichever occurs first, Axis Boats will repair materials, or workmanship supplied by it, in applying the gel coat and/or powder coat finish to the boat, or paint finish to the trailer, which are determined by Axis Boats to contain substantial manufacturing defects. This Gel Coat, Powder Coat and Trailer Paint Limited Warranty shall not include or provide coverage for gel coat finish, blistering, discoloration, scratching, cracks caused by negligence, impact or collision, stress crazing, fading or osmosis, or damage caused by in-water storage, scratches and other damage caused by trailering, including normal usage.

Section 3. Limited Warranty Exclusions and Limitations

In addition to any prior limitations and exclusions, the following are **NOT** covered under this Limited Warranty:



- normal maintenance of the Axis Boat, Monsoon Powertrain and/or Axis Trailer or any component thereof;
- normal wear-and-tear of the Axis Boat, Monsoon Powertrain and/or Axis Trailer or any component thereof;
- damages or needed adjustments caused by items that are added, altered or changed after the Axis Boat, Monsoon Powertrain and/or Axis Trailer leaves the possession of Axis Boats, including but not limited to installation of aftermarket towers, tower accessories, ballast systems, barefoot booms, canvas accessories, and hull bottom painting;
- modification, alteration, unauthorized repair or replacement of components, including but not limited to damages resulting from such installations, on the Axis Boat, Monsoon Powertrain and/or Axis Trailer;
- damages caused by accident (including impacts and collisions with any object), abuse, misuse, neglect, negligence, mishandling or alteration, including any damages caused by or during trailering or towing;
- damages caused by heat, fire, explosion or freezing (including the failure to perform proper winterization or preparations for storage or lack of use for periods in excess of thirty [30] days);
- damages caused by atmospheric fallout, chemical treatments, tree sap, salt, ocean spray, mold, animal droppings, lightning, hail, rain, flooding, wind, sand, floods or other environmental or natural conditions or Acts of God;
- staining, blistering, or discolorization resulting from failure to coat the hull with marine-grade hull paint on boats that are allowed to remain in bodies of water for extended periods (more than 14 days);
- damages caused by vandalism or theft;
- corrosion or damage, including oxidation, electrolysis including that which occurs to chrome plated, stainless, anodized or aluminum finish or the colorfastness of finish. Failure to follow the instructions within this Owner's Manual regarding corrosion prevention and operation in salt or brackish water may result in or contribute to these types of damage and are not covered under the Limited Warranty;
- damages caused by aftermarket cleaning products or additives not specifically approved by Axis Boats;
- damages due to insufficient or improper maintenance, lack of maintenance, or delay of repair (unless specifically and directly authorized by Malibu/Axis Boats warranty department in writing);
- damage or contamination resulting from leaking or spilled fluids including, but not limited to, fuel or powertrain fluids;
- conditions resulting from use of the boat for anything other than recreational purposes (Note: Commercial use as described in this Owner's Manual will affect the length of warranty coverage. Please refer to *Section 5: Commercial Use Exclusions / Restrictions* for specific details);
- manufacturing variations or imperfections in cosmetic, convenience or aesthetic components or features of the boat, including the gel coat finish, which have no effect on use or safety;
- damages caused by the use of any trailer purchased through any entity other than Axis Boats;
- damages caused by improper support of the boat on davits, hoist system or boat lift of any kind;
- damages caused by improper weight distribution or excessive weight combinations of persons aboard, ballast or simulated ballast and gear;
- any material, component or part of the boat that has a warranty period and/or conditions as specified by the producing entity which differs from this Limited Warranty unless such warranties are administered directly by the producing entity;
- damages caused by water intrusion into any part of the boat (including, but not limited to, the glove box and various storage compartments);
- performance characteristics, such as speed, acceleration, fuel or oil consumption, etc., as they are estimated and can vary as dictated by individual conditions;
- any and all consequential damages including, but not limited to, costs incurred for haul-out, launching, towing, storage charges, telephone, expedited shipping of replacement parts, or rental charges of any type (including slip fees), inconveniences, or loss of time or income;
- components such as Surf Gate™, fins and wedges not installed at the time of manufacture. Post-manufacture installation of any of these items, as well as any other component not installed at the time of manufacture, will void the warranty and other components of the boat that have their own warranty(ies) due to potential damage to the boat and possible danger to occupants;
- damage or injury resulting from failure to comply with recall notices, service bulletins and advisories, or requests from Axis Boats to repair the boat or its components;
- damage or injury resulting from speeding, demonstration or any type of racing;
- damages resulting from the failure to properly maintain and care for the boat and its components in accordance with the instructions found within this Owner's Manual;
- shop supplies used in correction work, such as, but not limited to, sealants, lubricants, cleaning supplies;
- minor adjustments to the powertrain, such as, but not limited to, investigation of components, cleaning or adjusting spark plugs, verification of fluid levels and lubricants, controls for the powertrain;
- damage to water pump impellers, or any component of the cooling system that Axis Boats determines, at its sole discretion, could have been avoided either through reasonable boating operation and practices or by maintenance as required and directed in this Owner's Manual;



- damage to the engine starter motor or other assemblies and components determined by Axis Boats, at its sole discretion, to be the result of excessive attempts to start the engine, or by condensation/submersion of these and similar components;
- damage resulting from water intrusion in the intake or exhaust system;
- damage resulting from the use of lubricants, gasoline, or other fluids other than those specified in this Owner's Manual or by subsequent approval by Axis Boats following publication of this Owner's Manual;
- damage to the powertrain resulting from a lack of sufficient cooling or the powertrain operation outside a sufficient body of water to provide adequate cooling, or cooling failure resulting from blockage by foreign objects;
- damage resulting from erroneous service by the customer or technician not authorized by Axis Boats to perform service or corrections;
- damage that cannot be traced to material defects in materials or workmanship, as determined by Axis Boats;
- damages resulting from the use of any non-Axis Boats-supplied boat cover (The sole and exclusive approved color for boat covers offered by Axis Boats is grey.); and
- the use, even temporarily, of a non-Axis Boat Trailer will void the Gel Coat & Powder Coat Limited Warranty.

Section 4: International Exclusions/Requirements

Importing or exporting any Axis Boat, Monsoon Powertrain and/or Axis Trailer manufactured in the United States by Axis Boats ("US Axis Boat," "US Monsoon Powertrain" and/or "US Axis Trailer") into Australia or New Zealand (the act of importing or exporting any US Axis Boat, US Monsoon Powertrain and/or US Axis Trailer into Australia or New Zealand) immediately and completely voids any and all coverage provided under this Limited Warranty and any and all obligations owed by Axis Boats relative to the US Axis Boat, US Monsoon Powertrain and/or US Axis Trailer. This Limited Warranty does not provide coverage to any US Axis Boat, US Monsoon Powertrain and/or US Axis Trailer purchased from a dealer in another country where the primary use of the US Axis Boat, US Monsoon Powertrain and/or US Axis Trailer will require the US Axis Boat, US Monsoon Powertrain and/or US Axis Trailer to cross an international border. The Limited Warranty will not be honored by Axis Boats for any US Axis Boat, US Monsoon Powertrain and/or US Axis Trailer that is acquired by the Purchaser through an international cross-border purchase. All repairs that are covered under this Limited Warranty must be performed in the country where the US Axis Boat, US Monsoon Powertrain and/or US Axis Trailer was originally purchased.

Section 5: Commercial Use Exclusions/Restrictions

The use of any Axis Boat, Monsoon Powertrain and/or Axis Trailer for commercial purposes, including but not limited to as a demonstrator, or in connection with any promotional program, ski, wakeboard, or surf school or show ("Commercial Purposes") shall alter the Limited Warranty as set forth herein. The Limited Warranty applicable to any Axis Boat, Monsoon Powertrain and/or Axis Trailer used for any Commercial Purpose may not be transferred to any subsequent owner of the Axis Boat, Monsoon Powertrain and/or Axis Trailer. The Limited Warranty coverage periods for any Axis Boat, Monsoon Powertrain and/or Axis Trailer that has been used for Commercial Purposes, while owned by the original Purchaser, are as follows:

Coverage Type	Coverage Period (from date of original retail purchase or initial use of the Axis Boat, whichever first occurs)
Structural Limited Warranty	Five (5) Years
Base Limited Warranty	Twelve (12) Months or 100 Hours
Gel Coat Limited Warranty	Six (6) Months
Powertrain Warranty	Earlier of twelve (12) Months or 300 Hours
Trailer Warranty	Twelve (12) Months

The repair and/or replacement of components or parts under warranty does not extend the warranty period beyond the original expiration date.

Section 6: Warranty Voiding Events

The following events will automatically void and discharge Axis Boats from its obligations under this Limited Warranty and discharge Axis Boats from any obligations herein:



- the unauthorized disconnection, tampering with, or altering of the Axis Boat's hour meter;
- the unauthorized disabling of any warning device or system installed in any Axis Boat and/or Monsoon Powertrain;
- the unauthorized disconnection, disturbance or compromise of any wires, hoses, tubes, cables, looms or other components of the Axis Boat's electrical or fuel systems;
- the use of the Axis Boat, Monsoon Powertrain and/or Axis Trailer in any criminal enterprise or to perform any criminal acts; and
- the determination by any state or federal entity or private insurance carrier that the Axis Boat, Monsoon Powertrain and/or Axis Trailer is a total loss or fit only for salvage.

Section 7: Other Matters Related to the Limited Warranty

In addition to the Limited Warranty terms and exclusions noted above, the following are additional important considerations regarding the Limited Warranty:

Section 7.1. Pre-Delivery.

Defects and/or damage to the finish surfaces, trim, upholstery or other observable cosmetic components of your Axis Boat, Monsoon Powertrain and/or Axis Trailer may occur during production. These items are usually detected and corrected prior to shipment to the dealership or by the retail dealer prior to delivery to the retail customer.

Nonetheless, consumers are encouraged to inspect the Axis Boat, Monsoon Powertrain and/or Axis Trailer for this type of damage prior to taking delivery, and all such defects or damage must be reported to the retail Axis Boat dealer at the time of delivery to have any items covered by this Limited Warranty addressed, and to have any covered defects repaired at no cost to the Purchaser.

Section 7.2. Boat Operation, Care and Maintenance.

To ensure the maximum benefit from ownership of this boat, Axis Boats requires that you follow all of the instructions in this Owner's Manual, including all accompanying maintenance or service schedules and support material. Because questions may sometimes arise relating to the cause of a particular failure, Axis Boats strongly recommends keeping detailed records of any and all maintenance or service performed on the boat, powertrain and/or trailer to assist, if necessary, in the determination of whether a failure is covered under this Limited Warranty. Damages to an Axis Boat, Monsoon Powertrain and/or Axis Trailer caused by improper operation, care and maintenance are not covered by this Limited Warranty.

Section 7.3. Design and/or Manufacturing Changes.

Axis Boats reserves the right to implement changes in the construction or components of any Axis Boat, Monsoon Powertrain and/or Axis Trailer at any time, without incurring any obligation to make the same or similar changes on Axis Boats, Monsoon Powertrains and/or Axis Trailers previously built and/or sold.

Section 7.4. Other Warranties.

Some manufacturers of component parts included in an Axis Boat, Monsoon Powertrain and/or Axis Trailer may provide limited warranties. Please refer to component part manufacturer's limited warranty disclosures, if any, for details, including their terms, conditions and limitations, of which Axis Boats makes no representations or warranties.

Among other warranties, note that certain items including, but not limited to, some powertrain parts, Biminis and boat covers are among those components covered by individual, separate warranties, which are explained and set forth in materials supplied by the component part manufacturer. Any and all claims or defects should be submitted directly to the manufacturers of those particular component parts.

Section 7.5. No Other Warranties.

No oral or written information, advice or communication of any nature by or from Axis Boats or its representatives, employees, dealers, agents, distributors or suppliers shall create a warranty or in any manner increase or modify the scope of this Limited Warranty. The repair and/or replacement of components or parts under warranty does not



extend the warranty period beyond the original expiration date.

Section 8: Customer Satisfaction Procedure

Section 8.1. Warranty Claim Procedure.

To obtain warranty service and/or repairs, the following steps are required:

(a) Notify a service facility or dealership authorized by Axis Boats to perform service or repairs to Axis Boats, Monsoon Powertrains and/or Axis Trailers (“Authorized Service Dealer”) or Axis Boats, Monsoon Powertrains and/or Axis Trailers of the substantial defect in materials or workmanship attributable to Axis Boats, within thirty (30) days of discovery of the defect (which must be in the applicable Coverage Period);

(b) Promptly schedule an appointment with and deliver the Axis Boat, Monsoon Powertrain and/or Axis Trailer to an Authorized Service Facility for repairs. Warranty service must be performed by Axis Boats or an Authorized Service Dealer. For assistance in locating an Authorized Service Dealer, please visit www.axiswake.com, select the “Find a Dealer” tab, and utilize Axis Boats’ Dealer Locator, or call Malibu Boats at (865) 458-7110;

* *Axis Boats reserves the right to require further evaluation and/or information regarding a warranty claim against an Axis Boat, Monsoon Powertrain and/or Axis Trailer prior to its repair as well as designate the place of repair.*

Subject to the terms of this Limited Warranty, any covered Axis Boat, Monsoon Powertrain and/or Axis Trailer or component part with a substantial defect in materials or workmanship that is returned to an Authorized Service Dealer during the appropriate Limited Warranty period will be repaired or replaced, in Axis Boats’ sole discretion, without charge to the Purchaser for parts and labor. This provision is subject to the following terms and conditions:

(a) Axis Boats shall be obligated only to repair or replace those items that prove defective, in Axis Boats’ sole discretion, upon examination by a qualified representative of an Authorized Service Dealer or Axis Boats’ own personnel, as applicable;

(b) Axis Boats warrants authorized repairs or replacements made by or on behalf of Axis Boats, Monsoon Powertrains and/or Axis Trailers only for the remainder of the applicable Coverage Period;

(c) The Purchaser shall be responsible for all costs associated with the transportation of the Axis Boat, Monsoon Powertrain and/or Axis Trailer, towing bills, trailer or component part(s) to Axis Boats’ facility and/or to the Authorized Service Dealer, as well as for any return transportation.

Note that Authorized Service Dealers, generally, are independently owned and operated businesses. Axis Boats does not control the scheduling of service work. However, if you encounter any material delays in obtaining service at one of Axis Boats’ Authorized Service Dealers, please call Axis Boats for assistance at (865) 458-7110.

Section 8.2. Direct Contact Information for Warranty Issues.

Boats built in the US:

Axis Boats, a subsidiary of Malibu Boats
5075 Kimberly Way
Loudon, TN 37774
(865) 458-7110
Axis Boats Internet Site: www.axiswake.com

Boats built in Australia:

Axis Boats Australia, a subsidiary of Malibu Boats Australia
813 Hope Crt
Albury, NSW 2640
(02) 6040 1174
Axis Boats Australia Internet Site: www.axiswake.com.au

Section 8.3. Procedure Regarding Concerns with Covered Warranty Repairs.

Concerns related to an Axis Boat, Monsoon Powertrain and/or Axis Trailer can normally be addressed by an



Authorized Service Dealer. If concerns are not satisfied, the following steps should be followed:

(a) Ask to discuss concerns with a member of the Authorized Service Dealer's management. Ordinarily this will be the Authorized Service Dealer's service manager or service foreman. If resolution of the issue is not achieved, request to speak with the Authorized Service Dealer's general manager or owner.

(b) If concerns are not resolved by the representatives of the Authorized Service Dealer, contact Axis Boats' Customer Service Department at the address noted above. Be prepared to provide the customer service representative with your name, address and phone number, your boat's hull identification number, the Authorized Service Dealer(s) at which the boat has been serviced, and the nature of the concerns with the boat or the service. Axis Boats will thereafter provide assistance to the boat owner and the Authorized Service Dealer, as necessary, to attempt to resolve the matter.

Section 8.4. Dispute Resolution.

EXCEPT TO THE EXTENT PROHIBITED BY ANY APPLICABLE STATE OR FEDERAL LAW, PRIOR TO INITIATING ANY LEGAL ACTION AGAINST AXIS BOATS, (1) YOU ARE REQUIRED TO PROVIDE AXIS BOATS WRITTEN NOTICE, AT THE ADDRESS ABOVE, OF ANY SUBSTANTIAL DEFECT IN MATERIALS OR WORKMANSHIP THAT REMAINS UNRESOLVED TO YOUR SATISFACTION UNDER THE TERMS OF THE LIMITED WARRANTY; AND (2) TO THE EXTENT PERMITTED BY ANY STATE OR FEDERAL LAW, YOU MUST FIRST USE AN AVAILABLE DISPUTE SETTLEMENT MECHANISM OR ARBITRATION.

Section 9. Warranty Transfer

Upon the first sale of an Axis Boat, Monsoon Powertrain and/or Axis Trailer that has not been utilized for any Commercial Purpose by the original, non-commercial, retail purchaser, within the first sixty (60) months, beginning on the date of the original retail purchase or the initial use of the Axis Boat, Monsoon Powertrain and/or Axis Trailer, whichever occurs first, any unexpired Limited Warranty coverage can be transferred to a second, non-commercial, owner and remain in effect for the unexpired period (except the Gel Coat & Powder Coat Limited Warranty, which is twelve [12] months), and the Structural Warranty, which becomes ten (10) years. The Limited Warranty on all other components is as previously identified within this Limited Warranty Statement. This provision is pursuant to the requirements set forth in the Warranty Transfer information provided within this Owner's Manual. Only one transfer of the Limited Warranty within the applicable time period(s) established will be honored. All coverage under the Limited Warranty Statement will become null and void in totality with any subsequent conveyance of ownership of the Axis Boat, Monsoon Powertrain and/or Axis Trailer or transfer of the Axis Boat's or Axis Trailer's title to any third party.

Warranty Transfer

- The Axis Boat, Monsoon Powertrain and Axis Trailer (herein called the "boat package") may be transferred from the original owner to a second private owner within the first five (5) years of the original date of purchase to the second owner only. The boat package is not eligible to be transferred to a third owner for purpose of warranty coverage.
- The boat package may transfer within the first five (5) years of ownership from the date of purchase. After five years from the date of original purchase, a warranty transfer is no longer eligible.
- The boat package must be fully inspected by an authorized Axis dealer. The dealer will complete a warranty transfer specific to that boat package. The transfer must be signed by the second private owner. The transfer forms are available through the dealership only.
- Consumer payment must be made to the dealer directly in the amount of \$1,250.00. Payment cannot be made directly to Axis. The dealer will complete the warranty transfer process on behalf of the seller and buyer.

CALIFORNIA AND U.S. EPA EMISSION CONTROL WARRANTY STATEMENT

Your Warranty Rights and Obligations

The California Air Resource Board ("CARB") and the United States Environmental Protection Agency ("EPA"), together with Axis Boats, a subsidiary of Malibu Boats, LLC ("Axis Boats") are pleased to explain the Emission Control System Warranty ("ECS Warranty") on your 2024 inboard engine. In the United States, new inboard engines must be designed, built and equipped to meet all Federal- and State-mandated anti-smog standards.



Axis Boats must warrant the emission control system on your inboard engine for the periods of time listed below, provided there has been no abuse, neglect or improper maintenance of the inboard engine. Your emission control system may include parts such as the fuel injection system and the ignition system. Also included may be hoses, belts, connectors and other emission-related assemblies.

Where a warrantable condition exists, Axis Boats will repair your inboard engine at no cost to you, including diagnosis, parts and labor.

Manufacturer's Warranty Coverage

Select electronic emission-related control parts from model year 2019 forward on Axis Boats inboard engines are warranted for five (5) years or 500 hours as recorded on the boat's hour meter, whichever comes first.

If any emission-related part on your engine is defective under warranty as described in the Axis Boats Limited Warranty Statement, the part will be repaired or replaced by Axis Boats.

Owner's Warranty Responsibilities

As the inboard engine owner, you are responsible for the performance of the required maintenance listed in this Owner's Manual. Axis Boats recommends retaining all receipts received as a result of the maintenance performed on your inboard engine. Axis Boats cannot deny warranty solely for the lack of receipts or your failure to ensure the performance of all scheduled maintenance.

Axis Boats may deny warranty coverage if the inboard engine or component part has failed due to abuse, neglect, improper maintenance or unapproved modifications.

To receive warranty correction(s), you are responsible for presenting your inboard engine to an Axis Boats authorized servicing dealership as soon as a problem exists. The warranty repairs will be completed in a reasonable amount of time not to exceed thirty (30) days.

If you have questions regarding your warranty rights and responsibilities, please contact Axis Boats at (865) 458-7110.

General Emissions Warranty Coverage

The Axis Boats engine is designed, built and equipped to conform with all applicable regulations adopted by CARB, pursuant to its authority in Chapters 1 and 2, Part 5, Division 26, of the Health and Safety Code, and by the EPA pursuant to 40 CFR 1045. The engine is warranted that it is free of defects in materials and workmanship that could cause the failure of a warranted part. It is identical in all material respects to parts as described in the engine manufacturer's application for certification.

Exclusions

The engine's owner is referred to the Axis Boats' Limited Warranty Statement for general guidelines regarding warranty provisions. Note that damage or failure resulting from circumstances other than those for which provision is made in the Limited Warranty Statement and this Emissions Control Warranty Statement are not covered by warranty. This warranty does not cover damage or failure resulting from owner abuse, neglect, improper maintenance, or modification with unapproved parts or components. The warranty also does not cover expendable maintenance items used in connection with routine and/or required maintenance. Such examples include, but are not limited to, filters, spark plugs or fluids. If a part or component requires repair or replacement, the life of the warranty is not extended beyond its original expiration date.

Disclaimer

This Emissions Control Warranty is applicable only where CARB and/or U.S. EPA emission control system warranty regulation is in effect. The use of additional or modified part(s) is not exempt. If a non-exempt part or component causes the failure of a warranted part or component, the warranted part or component will not be covered under warranty.



Emission Control Parts Covered Under Warranty

The following components are considered part of the emissions control system for your inboard engine and will be warranted under the guidelines of this warranty:

- exhaust manifold;
- exhaust valves;
- PCV valve;
- oil filler cap;
- oil pump, including internal parts;
- intake manifold;
- spark arrestor/air filter;
- intake valves;
- serpentine belt;
- hoses;
- clamps;
- fittings;
- pulleys/idlers;
- mounting hardware;
- tubing;
- sealing gaskets or devices;
- fuel injectors;
- fuel pump;
- pressure regulator;
- ignition wires;
- ignition coil;
- spark plugs;
- sensors, including, camshaft position, crankshaft position, engine coolant temperature, intake air temperature, knock, manifold absolute pressure (MAP), throttle position, electronic control unit, electronic throttle control, camshaft position actuator solenoid valve, oil pressure, and oxygen;
- carbon canister;
- fuel tank;
- purge valve, where installed;
- non-metal, low-permeation hoses.



troubleshooting

TROUBLESHOOTING THE BOAT

General

Issue: The boat will not start.

Consider:

- Verify that the battery switch is ON.
- Be certain the Emergency Safety Stop Switch is attached to the connection point on the driver's panel and to the boat operator.
- Be certain the engine electrical system is ON. Generally, this requires turning the ignition key ON or pressing the ON button.
- It is possible the display is in a "sleep" mode. Press a key or touch the screen to see if the affected display activates.
- Verify that the battery connections are secure.
- Refer to the *Engines* section of this manual for additional suggestions.

Issue: The boat will not shift into gear.

Consider:

- When engaging the transmission from neutral either forward or backward into reverse, pull up on the safety collar located directly below the throttle lever knob. The safety collar helps avoid unintentional movement into gear.
- When shifting gears, always do so smoothly and briskly. Being either too hard and slamming the gears, or too tentative, is hard on the shifter/throttle system and can result in damage that is not covered under warranty.

Issue: The engine/drivetrain is not operating properly.

Consider:

- Refer first to the engine manual or the *Engines* section of this manual for guidance.
- Check the fuel level in the boat to be certain that the engine is not "starving" from lack of fuel or contaminated fuel.
- Check for engine warning messages on the gauges/display. If any are present, take the boat to the closest authorized Axis dealer for evaluation and repair.

Gauges, Switches and Video Screens

Issue: A gauge or video screen does not light up and work as expected.

Consider:

- Be certain the engine electrical system is ON. Generally, this requires turning the ignition key ON or pressing the ON button.
- It is possible the display is in a "sleep" mode. Press a key or touch the screen to see if the affected display activates.
- Verify that the battery connections are secure.
- Determine if other gauges, switches and/or video screens are operational. If they are, check the circuit breaker panel to determine if the breaker has tripped. Reset. If the circuit continues to trip, the boat must be serviced by an authorized Axis dealer as it indicates a recurrent and potentially significant problem. Another cause is a loose electrical connection to the non-working gauge/switch/video screen. This matter should be addressed by an authorized Axis dealer.
- If a video screen freezes or displays an unreadable or invalid screen, turn the entire system OFF, including the engine electrical system. Allow a few minutes for the system to reset itself, and then try rebooting the system. If the issue persists or another issue arises, take the boat to an authorized Axis dealer for correction. Where equipped, check the battery isolator switch.

Electrical Systems

Issue: A boat component that is electrically operated will not operate.

Consider:

- Be certain the boat electrical system is ON. Generally, this requires turning the ignition key ON or pressing the ON button.
- Verify that the battery connections are secure and that there is sufficient charge and power. See the Battery information in this manual for additional details.



- Verify that the circuit breaker has not tripped. If it has, reset it. Recurrent trips are indicative of a problem that requires the attention of an authorized Axis dealer.
- Check for loose connections, but do not remove any closeout panels to do so. If a loose connection is suspected but cannot be seen, have the system checked by an authorized Axis dealer.
- If the component is electronic, be certain the component is operational. If it requires reception from a satellite, tower or other supplier, Axis cannot guarantee that it will receive the signal. It may be necessary to move the boat to another location or body of water, or pay a subscription fee.

Issue: Accessories will not recharge in the 12-volt receptacle.

Consider:

- Verify that the correct charger was used for the item(s) and that the charger plug-in was fully seated in the 12-volt receptacle.

Battery Failure

Often, a battery that will not start the boat requires recharging. Use **ONLY** a marine-approved battery charger. Any other can damage the electrical system, and such damage is not covered under warranty. **NEVER** attempt to “jump” from a vehicle or another boat as there is a potential for overload that could significantly damage the boat’s electrical system, which is not covered under warranty! Read the battery information provided in the *Dashes and Video Screens* section of this manual before undertaking any attempt to replace, use both batteries simultaneously, or replace the battery.

Alarms

Issue: The low voltage alarm sounds.

Consider:

- Most often, this signals the need to turn OFF and leave OFF the stereo component or similar electronics that require substantial support from the batteries. Start the engine and allow the alternator to recharge the batteries, which will require a fairly short period of time if there is no additional drain occurring during the recharging time. If this does not work, it may be that the battery or batteries are nearing their terminal life span.

Issue: Another alarm sounds.

Consider:

- These occur when a sensor detects that the engine or transmission temperature range or oil pressure range have exceeded programmed limits. The boat’s main system may begin shutting off peripheral activity to retain proper operation as long as possible. It is usually in the operational best interest to return to shore as soon as possible to avoid being stranded. Even if the ranges return to acceptable operating range, this matter should be shared with the service department of your authorized Axis dealer to determine the cause and avoid a repeat.

Bilge and Ballast

Issue: The bilge pumps are not operating.

Consider:

- The bilge pump(s) should operate automatically. If it does not, use the manual switch. If it still does not operate, return to shore **IMMEDIATELY** and terminate the outing. See an authorized Axis dealer before the next outing to ensure the bilge pumps are working properly. Failure to pump water out of the bilge can result in the boat swamping. This could result in serious injury or death to those on board.

Issue: The ballast pump is not operating.

Consider:

- If the ballast pump does not pump water into the system, and having verified that the electrical system is operational, leave the pump OFF and have it serviced by an authorized Axis dealer. If the pump does not pump water out of the system, seek assistance by calling your Axis dealer. You should never attempt to tow your boat on a trailer with water in the ballast system as it could cause damage to the trailer, which can result in the driver losing control while towing. Such activity could result in serious injury or death to anyone in the area.
- Additional information on the bilge and ballast systems can be found in the *How It Works* and *Care and Maintenance* sections of this manual.



Blower System

Issue: *The blower is not working.*

Consider:

- **Never operate the boat without the blower system operating correctly!** Accumulating fumes that are not released through the blower system can result in an explosion or other serious accident that could result in death to those on board. If the blower ceases to work properly while boating is underway, terminate the outing **IMMEDIATELY** and return to shore with the engine compartment covers open. If there is an odor of fuel or exhaust present, turn OFF the engine **IMMEDIATELY** and seek a tow to shore. See the *Safety* section of this manual; additional details are also available in the *How It Works* and *Care and Maintenance* sections, as well.

Steering System

Issue: *The boat's steering is responding poorly.*

Consider:

- Anytime the steering does not respond crisply to turns by the steering wheel, discontinue the outing and return to shore as soon as possible. The steering components are, generally, inaccessible to boat operators and owners. Repairs should be completed by an authorized Axis dealer.
- Inboard-engine boats have an inherent pull to one side due to rudder torque. While some can be adjusted, it is possible that all pull cannot be eliminated.

Power Wedge and Surf Gates

Issue: *The Power Wedge and/or the Surf Gates are not operating as designed.*

Consider:

- See the information provided in the *Care and Maintenance* section of this manual for information about how to manually move these components. However, you may want to take the boat to your authorized Axis dealer for assistance and to address warranty issues.

Lights

Issue: *Any light system is not working properly.*

Consider:

- See the *Electrical* troubleshooting information above.

TROUBLESHOOTING THE TRAILER

Whenever possible, it is advisable to have issues with the trailer addressed by a trained service technician at an authorized Axis trailer dealer. However, there can be instances when this is not feasible, particularly in cases of emergency or distance from the dealer. The following troubleshooting advice is not guaranteed to fix the issue, and Axis Trailers does not warrant any repair effected by other than a trained service technician at an authorized Axis dealership. If you must troubleshoot the trailer and/or its components while the trailer is under warranty, we recommend having a follow-up consultation with the dealer.

Here are some of the more common issues that may arise:

Issue: *The coupler latch handle does not open or close, or does not open/close smoothly and easily.*

Consider:

- Verify that the hitch ball is the specified, correct size.
- The hitch ball may not be fully seated within the socket.
- The trailer and tow vehicle may not be level.
- Ensure there is no debris or foreign objects interfering with the match.
- Ensure there is sufficient lubrication in the moving parts.
- Verify that there is little to no corrosion on any of the metal parts.



Issue: The tongue actuator is making unusual noises, including, but not limited to, clunking or squawking.

Consider:

- The shock absorber inside the tongue may be worn and require replacement by an authorized Axis Trailer dealer.
- The brakes may require bleeding as there is air in the system that is allowing the actuator to malfunction.
- The hitch ball may be too small, too worn or require some lubrication.

Issue: Braking is uneven, including instances of the brake releasing when the driver's foot is on the brake pedal in the tow vehicle.

Consider:

- There may be an issue in the tongue actuator such as a worn shock absorber.
- The hitch ball may not be seated properly in the socket.
- There is too little or too much weight percentage on the tongue.
- The tow vehicle's shock absorbers are too worn.
- The brakes need adjustment.
- The brake lines require a re-bleeding.
- Verify that the brake linings, rotors, calipers and other components are correctly aligned and operational.
- Verify that the master cylinder is not corroded.
- Verify that the brake lines are not rusted or corroded.
- Check to determine if the breakaway cable has pulled free.

Issue: Brakes perform poorly, beyond the intermittent issues mentioned above.

Consider:

- The brake shoes or disc pads may be worn beyond acceptable use.
- Corrosion/rust is preventing the brakes from operating as designed.
- Verify that there is a sufficient amount of brake fluid in the reservoir. Re-bleed as necessary.
- Verify that the brake lines are not damaged.
- The master cylinder may be malfunctioning.
- Adjust the "gain" control on the in-cab controller.
- Verify that the electrical wire connections are connected.

Issue: A single brake is overheating.

Consider:

- The trailer may have been stored with the actuator compressed and rust is in the system.
- A brake line may have been pinched, broken or damaged and is inhibiting or preventing brake fluid from circulating.
- There are several other potential causes for this problem. Due to the technical nature of the potential causes, it is best to have the system checked by an authorized Axis Trailer-trained service technician.



NEVER tow a trailer with faulty brakes. Whether the brakes are grabbing or failing to respond, the result is usually a loss of control of the entire rig. This situation can result in serious injury or death to persons on board, and damage to the tow vehicle and/or trailer and boat, as well as to other people and vehicles on the road at the time.



service log

Service Performed	Date	Date	Date	Date	Date	Date	Date	Date	Date	Date
Oil Change and Oil Filter Replacement										
Wax Exterior										
Thoroughly Clean Interior										
Replace Battery										
Charge or Replace Fire Suppression Equipment										
Check/Repair PFDs and Other Safety Equipment										
Check/Repair Engine Mounts										
Check/Repair Steering System										
Check/Repair Shift & Throttle System										
Inspect/Repair/Replace Ballast Pumps										
Inspect/Repair/Replace Bilge Pumps										
Replace Fuel Filter/ Inspect Fuel Lines										
Check/Repair Wedge & Surf Gate Operation										
Check Hull Paint (where applied)										
Prepare for Storage/ Winterization										
Recommission Boat										
Other										
Other										
Other										
Other										



index

7" Garmin Display..... 38
12-Volt Receptacles 48

A

A20..... 32
A225..... 33
A245..... 34
Accessory Keypads..... 42
Additional Precautions for Towed Skier/Rider 24
Additional Steps to Complete for Storage 140
After 10 Hours on the Hourmeter 132
After 50 Hours or Annually 132
After Starting the Engine..... 131
 Check Battery and Fuel..... 131
 Check for Odors..... 131
After the Outing..... 131
Aids to Navigation 20
Alarms..... 51
Alpha Flag 21
Anchoring 115
Anchor Light 72
Approved Upholstery Colors..... 122
Attaching to the Tow Vehicle 96
Auto-Set Wedge..... 87
Axis Fuel System..... 60, 111
Axles 99

B

Ballast System 51, 85
Basic Electrical Components 44
Basic Rules of the Road 18
Basic Safety Rules 1, 93
Batteries..... 45
Battery..... 133
Battery Charger 47
Before Starting the Engine..... 128
 Check Coolant Level..... 128
 Check Flush Kit Cap 131
 Check for Odors..... 130
 Check the Battery Holders and the Connections 129
 Check the Engine Oil Level..... 129
 Inspect the Sea Strainer 129
Bilge Pump(s)..... 9
Bilge Pumps 50
Bilge System..... 84
Bimini Top..... 81
Blower System 49, 83

Boat Configuration Settings..... 41
Boating Regulations 18
Boating Safety Education Opportunities 5
Both Vessels 30
Bow Safety Strap 108
Brakes..... 104
Breakaway Cable 95
Break-in Period..... 113
Break-In Procedure..... 67
Burdened Vessel 19

C

Calibration Settings..... 41
California Emissions Information..... 57
Canvas..... 119
Capsizing 28
Carbon Monoxide..... 26
Carbon Monoxide Safety..... 10
Care and Maintenance..... 119
Circuit Breakers 44
Clamping Spinner Board Racks or Ski Rack 82
Cleaning Agents..... 16
Cleaning, Maintenance, and Storage 110
Cleats..... 73
Collisions..... 29
Connecting to the Boat 97
Connection to the Tow Vehicle..... 94
Controls Screen..... 40
Coolant System 134
Cooling System 64
Courtesy Lights 72
Crossing..... 19
Cup Holders 79

D

Dam Spillways..... 15
Dashes and Video Screens..... 38
Depth Alarm..... 107
Develop WATER SENSE 25
Diagnostic Settings..... 42
Discharge/Disposal of Waste 15
Distress Flag..... 21
Diver's Flag..... 21
Docking and Tie-Up..... 115
Docking Lights 72
Drowning 30



E

Electrical Harnesses and Wiring	45
Electrical Systems.....	49
Electronic Throttle Control (ETC).....	76
Embracing Safety.....	1
Emergency Back-up Key Switch.....	72
Emergency Procedures.....	27
Emergency Safety Stop Switch.....	6, 71
Encountering Another Vessel.....	18
Engine and Powertrains.....	54
Engine Coolant.....	56
Engine Fuse Box	44
Engine Oil.....	56
Engine Sensors	47
Engine Specifications.....	56
Engines, Transmissions, and V-Drives.....	54
Engine Support Systems.....	60
Environmental Concerns.....	15
EPA Emission Warranty Statement.....	149
Excessive Noise	15
Exhaust Emissions.....	16
Exhaust System	66
Explosion.....	28
Explosion and Fire	28
Extended Non-Use.....	137

F

Fallen Skier or Rider	25, 27
Final Checks Before Starting.....	112
Fins	89
Fire.....	28
Fire Extinguisher	8
Fire Extinguishing Equipment	70
Flushing the Ballast Tank System.....	87
Flush Kit.....	90, 126
Foreign Species.....	15
For Extended Storage and Winterization.....	139
Fuel Fill.....	74
Fuel Filter.....	57
Fuel Information	61
Fuel/Oil Spillage.....	15
Fuel System	136
FWMS System.....	20

G

Gauge Screen.....	40
General Boating Safety Topics.....	10
General Cleaning.....	119
Glove Box.....	77
Grab Handles.....	79
Grounding.....	29

H

Hand Signals.....	23
Hazardous Conditions.....	14
Heater.....	79
High Speed Maneuvers	114
Hitching.....	97
Horn.....	74
Horn or Whistle	8
How It Works.....	70
How to Connect to the Tow Vehicle	96
Hull and Deck Finishes	123
Hull Gel Coat.....	137
Hydraulic Steering Fluid	57
Hydraulic Steering System	136

I

Icon 8 or Rev 10 Tower Speakers (2 or 4)	82
Important Safety Information	4
Instrument Panel.....	38
Insurance	5
Interior Luxury.....	76
Interior Performance.....	75

L

Launching and Reloading the Boat from the Trailer.....	109
Legal Requirements for Towing.....	93
Lifting the Boat.....	137
Lighting.....	71
Lights.....	99
Limited Warranty Statement.....	142
Lug Nuts	100

M

Maintenance Schedule.....	57, 141
Manufacturer's Warranty Coverage.....	150
MARPOL Treaty	16
Medical Emergency.....	30
Meeting Head-On.....	19
Mirror.....	74
Mooring Buoys	21

N

Navigation Lights.....	6, 72
Night Running.....	22

O

Oil System	134
Ongoing Care	119
On-Product Warning Labels.....	16
Operation by Minors and Licensing	5



Operation Failure	30
Operations.....	112
Other Rules of the Road.....	20
Other Safety Double Checks.....	55
Overtaking.....	19
Owner Responsibility and Boating Education.....	4
Owner's Warranty Responsibilities.....	150

P

Paints	16
Passenger Safety	10
Personal Flotation Devices.....	7
Person Overboard	29
Phone Holder.....	49
Power Wedge III.....	88
Precautions While Underway.....	2
Pre-operation Check List	1
Preparing to Ski or Ride	27
Pre-Tow Check List	108
Prior to Operation	55
Prior to Towing.....	108
Privileged Vessel.....	18
Product Misuse.....	14
Propeller.....	90
Proper Loading.....	12
Pumps	134
Pylon(s).....	76

Q

Quick Reference Guide.....	31
----------------------------	----

R

Raw Water Intake / Sea Strainer	90
Recommended Safety Equipment	9
Recommended Seating.....	31
Registration.....	5
Removable Cooler	78
Removable Guide Poles	98
Rendering Assistance.....	14
Reporting Accidents	14
Responsibilities of Boat Owner and Operators.....	4
Restricted Areas.....	15
Routine Maintenance	127
Routine Salt Water/Brackish Water Protection.....	125
Rudder.....	89

S

Safe Speed.....	10
Safety.....	1
Safety and Required Equipment.....	6
Safety Cables	95

Safety While Maintaining the Vessel.....	3
Saltwater Care and Maintenance.....	124
Saltwater Series.....	91
Seating	77
Serial Numbers.....	55
Service Log.....	156
Settings Screen	41
Shallow Water Operation	14
Shifter/Throttle.....	75, 133
Signal Words and Symbols Used in this Manual	1
Skiing or riding	27
Smart Operations	114
Soft Grip	79, 123
Speed/Wake/Wash	16
Sport Dash Keypad.....	42
Stainless Steel, Chrome, and Aluminum Components	124
Star Label	59
Starting the Engine.....	112
Staying Afloat	29
Steering System.....	133
Steering Wheel.....	75
Stereo Components.....	76
Storage and Winterization	137
Storage Compartments	78
Struts and Strut Housing.....	89
Surf Band.....	48
Surf Gate	88
Swamping and Flooding.....	28
Swim Board.....	91, 123
System Settings	41

T

T220	35
T235	36
T250	37
The General Prudential Rule.....	19
Tie-Downs	98
Tie-Ups.....	73
Tires	101
Towed Person Safety Responsibilities	23
Tower Accessories	81
Tower, Canvas, and Accessories.....	80
Tower Mirror.....	83
Towing.....	30
Towing Advice	108
Towing Vessel.....	30
Tow Line Guidelines	25
Tow Ropes.....	27
Trailer Components	98
Trailer Hitch	94
Trailer Jack	98



Trailers.....	93	Winterizing the Flush Kit.....	138
Trailer Winch.....	97	Winterizing with the Boat in Water.....	138
Transmission Fluid.....	57	Wireless Charging Phone Holder.....	49
Transmissions.....	68		
Troubleshooting - Boat.....	152		
Alarms.....	153		
Battery Failure.....	153		
Bilge and Ballast.....	153		
Blower System.....	154		
Electrical Systems.....	152		
Gauges, Switches and Video Screens.....	152		
General.....	152		
Lights.....	154		
Power Wedge and Surf Gates.....	154		
Steering System.....	154		
Troubleshooting - Trailer.....	154		
Types of Buoys.....	21		
U			
Unassisted Means of Reboarding.....	29		
Underwater Gear.....	89		
Underwater Transom Lights.....	72		
Unhitching.....	97		
Uniform State Regulatory Markers.....	21		
Uniform State Waterway Marking System (USWMS).....	21		
Upholstery.....	121		
USWMS System.....	20		
V			
V-Drives.....	69		
Vessel Being Towed.....	30		
Visibility of the Operator.....	13		
Visual Distress Signals.....	9		
W			
Warning Labels & Locations.....	16		
Warning Markers.....	14, 21		
Watercraft Safety.....	26		
Watersports Responsibility Code.....	25		
Watersports Safety.....	23		
Watersports Safety Code.....	25		
Watersports Screen.....	38		
Weather/Seas.....	15		
Weeds.....	15		
Weight Distribution.....	95		
Weighting Your Boat During Watersport Activities.....	12		
Wheel Chocks.....	107		
Wheels and Hubs.....	100		
When Fueling.....	62		
When the Boat Is Not in Operation (Fuel).....	63		
Winterizing Procedure.....	138		

