

CUSTOMER ACKNOWLEDGEMENT

Hull Identification Number: _____

Retail customer acknowledges that they have received a copy of the Malibu Boats / Axis Owner’s Manual and that the dealer has reviewed the following with you:

- Where to obtain service
- Terms of the Limited Warranties (trailer, engine, boat, etc.)
- Proper and safe operation of the boat
- All sections of the Owner’s Manual(s)

Retail customer acknowledges that the dealer has explained the operation and maintenance requirements of their trailer (as provided at the time of purchase) and that any trailer that is not provided as part of the OEM package at the time of manufacture, as well as any associated damage to the boat due to non-factory trailer usage, is specifically excluded from Warranty Coverage.

Retail customer acknowledges that the warranty for this boat will be voided if unauthorized components are added to the boat after the retail purchase unless specifically authorized by Malibu Boats, LLC. This includes components such as Surf Gates™, fins, wedges, etc.

Customer Name(s)

Print Name _____
Print Name _____
Print Name _____

Customer Signature(s)

Sign Name _____
Sign Name _____
Sign Name _____

Dealer Name(s)

Print Name _____
Print Name _____
Print Name _____

Dealer Signature(s)

Sign Name _____
Sign Name _____
Sign Name _____

Return of this form to Malibu Boats / Axis is a condition of Warranty Coverage. Selling Dealer must return this form to Malibu Boats / Axis via email (warrantyregistrations@malibuboats.com) during the Warranty Registration process.

This form must also be completed as part of a Warranty transfer and returned to Malibu Boats before any remaining Warranty can be transferred to a subsequent owner.

All information and specifications included in this manual were in effect at the time of approval for printing. Malibu Boats LLC reserves the right, however, to discontinue or change specifications or design at any time without notice and without incurring any obligation.

Trademarks

Malibu and The Malibu Logo are registered trademarks of Malibu Boats LLC.

Surf Gate is a trademark of Malibu Boats LLC.

All other product names are copyright and registered trademarks/trade names of their respective owners.

© 2000-2014 Malibu Boats LLC.

All Rights reserved.

Printed in the USA

CONTENTS

CONTENTS	v	Speedometer Pickup	2-55
TABLE OF FIGURES	vi	Tilt Steering Wheel	2-55
INTRODUCTION	vii	Exhaust	2-56
CERTIFICATIONS & STANDARDS	vii	Ventilation	2-56
BOATING SAFETY	1-1	Closed Cooling System	2-57
Introduction	1-1	Optimal Equipment	2-57
Basic Safety Rules	1-3	Tower	2-67
Owner Responsibility and Boating Education	1-8	Viper Chart Plotting Instructions	2-69
Safety and Required Equipment ..	1-10	Wedge	2-91
General Boating Safety Topics ..	1-16	OPERATION	3-1
On Product Warning Labels	1-29	Trailering	3-1
Basic Rules of the Road	1-32	Fueling	3-6
Watersports Safety	1-44	Starting	3-8
Emergency Procedures	1-54	Shifting/Running	3-10
GAUGES & CONTROLS	2-1	Steering	3-11
Standard Gauges	2-1	Stopping	3-13
Power Wedge	2-25	Docking	3-13
Circuit Breakers	2-27	High-Speed Operation	3-14
Switches & Indicators	2-27	Towing Another Boat	3-15
Throttle Control	2-45	Anchoring	3-15
Steering System	2-46	Propellers	3-16
Emergency Engine Stop Switch ..	2-46	Malibu Exclusive Adjustable Rudder System	3-17
Engine Compartment Fire Extinguisher	2-47	Corrosion Protection	3-18
Motorbox Cover	2-48	CARE AND MAINTENANCE	4-1
Driver's Seat	2-48	Interior	4-1
Integral Self Draining Ice Chest	2-49	Exterior	4-3
Sundeck	2-49	Engine/Drive Train	4-5
V-Drive Engine Access Hatch	2-49	Steering System	4-5
Ski Pylon	2-50	Fuel System	4-6
Swim Platform	2-50	Electrical	4-8
Navigational Lights	2-51	Go Home Feature	4-9
Go Home Feature	2-51	Miscellaneous	4-12
Storage Areas	2-52	Troubleshooting	4-15
VTX Table Installation	2-53	Glossary	4-18
Drain Plugs	2-54	Index	4-19
		MALIBU BOATS LIMITED WARRANTY	W-1

TABLE OF FIGURES

Figure 2-1 Graphical Display (TXi, Response, Response LX)	2-1	Figure 2-42 Thru-Hull Paddle Wheel Pickup	2-55
Figure 2-2 MaliView Dash with Malibu Touch Control (All Wakesetters)	2-1	Figure 2-43 Tilt Steering.	2-55
Figure 2-3 Dash Display (VTX20, TXi – optional)	2-1	Figure 2-44 Heater	2-57
Figure 2-4 Tachometer with Oil, Volt Hourmeter	2-3	Figure 2-45 Boat Cover	2-57
Figure 2-5 Speedometer with Depth, Air and Lake Temperature Gauge	2-3	Figure 2-46 Stereo.	2-58
Figure 2-6 Dash Gauges	2-4	Figure 2-47 Optional Transom Remote	2-58
Figure 2-7 In-Dash Display	2-5	Figure 2-48 MaliView Media	2-65
Figure 2-8 MaliView In-Dash Display	2-6	Figure 2-49 RCA Adapter.	2-65
Figure 2-9 Cruise Control	2-20	Figure 2-50 Shower Head	2-66
Figure 2-10 Power Wedge	2-25	Figure 2-51 Shower Valve	2-66
Figure 2-11 Power Wedge	2-25	Figure 2-52 Pull-Up Cleat.	2-66
Figure 2-12 Power Wedge	2-26	Figure 2-53 Boat Bumpers Quick Release	2-66
Figure 2-13 Circuit Breaker Panels.	2-27	Figure 2-54 Tower Latch	2-67
Figure 2-14 Horn Button and Power Button	2-27	Figure 2-55 Starboard Side	2-68
Figure 2-15 Remote Ignition Key Switch	2-28	Figure 2-56 Port Side	2-68
Figure 2-16 Ride Series and Response/LX Switch Panel	2-40	Figure 2-57 Wedge Down.	2-91
Figure 2-17 Inline Fuse	2-40	Figure 2-58 Wedge Up	2-91
Figure 2-18 Optional Rear MUX Switch	2-41	Figure 3-1 Trailer Hitch	3-1
Figure 2-19 Throttle Lever	2-45	Figure 3-2 Safety Chains	3-2
Figure 2-20 Emergency Engine Stop Switch	2-46	Figure 3-3 Bow Tie-Down	3-3
Figure 2-21	2-47	Figure 3-4 Transom Tie-Down	3-3
Figure 2-22	2-47	Figure 3-5 Fueling.	3-6
Figure 2-23	2-47	Figure 3-6 Throttle Positions	3-10
Figure 2-24 Motorbox – Direct Drive Models.	2-48	Figure 3-7 Turning with a Rudder	3-11
Figure 2-25 Bolster Seat	2-48	Figure 3-8 Stern Push	3-12
Figure 2-26 Lumbar Adjuster	2-49	Figure 3-9 Docking with Wind/Current	3-14
Figure 2-27 Seat Adjuster	2-49	Figure 3-10 Towing	3-15
Figure 2-28 Sundeck.	2-49	Figure 3-11 Propeller	3-16
Figure 2-29 Engine Access Hatch.	2-49	Figure 3-12 Adjustable Rudder.	3-17
Figure 2-30 Pivoting-Head Ski Pylon.	2-50	Figure 4-1 Drip Less Shaft Packing	4-5
Figure 2-31 Swim Platform	2-50	Figure 4-2 P-Trap and Deck Fill	4-7
Figure 2-32 Swim Step Pin Removal	2-50	Figure 4-3 FLVV	4-7
Figure 2-33 Swim Step Ladder Strap	2-51	Figure 4-4 GRV	4-7
Figure 2-34 Bow Light	2-51	Figure 4-5 ICV	4-7
Figure 2-35 Transom Storage – Direct Drive Models.	2-52	Figure 4-6 Attwood Carbon Canister	4-7
Figure 2-36 Glove Box Storage	2-52	Figure 4-7 Main Circuit Breaker.	4-8
Figure 2-37 Table Top and Table Support Pole	2-53	Figure 4-8 Battery Level.	4-9
Figure 2-38 Mounted Receiver.	2-53	Figure 4-9 Battery Switch.	4-11
Figure 2-39 Table Receiver	2-53		
Figure 2-40 Transom Drain Plug	2-54		
Figure 2-41 Bilge Drain Plug	2-54		

INTRODUCTION

Over the years, you have watched us grow into one of the most respected boat builders in the world, and undoubtedly, somewhere, you have run into at least one Malibu owner who proudly speaks of the “Malibu Difference.” That difference they so proudly speak of could be the special way we have serviced them over the years. We call it “going the distance.” Maybe they are referring to the way their Malibu consistently outperforms other ski boats that they have driven. We can’t deny that we are different. Our passion for building the perfect ski boat is only surpassed by our commitment to total customer satisfaction.

This manual has been assembled to help you operate your new Malibu with safety and pleasure. Details of typical equipment as well as recommended safety and maintenance procedures about your boat are supplied. Please read carefully and familiarize yourself with the craft before using it.

We at Malibu Boats thank you for choosing us as your boat manufacturer and assure you that your satisfaction and boating enjoyment will continue to be our #1 priority.

CERTIFICATIONS & STANDARDS

NMMA Certification

Your Malibu boat has been built to meet or exceed the standards set by the National Marine Manufacturers Association (NMMA). NMMA verifies annually, or whenever a new boat model is introduced, to determine that they meet not only Coast Guard regulations, but also the more comprehensive standards set by the American Boat & Yacht Council (ABYC).

Standards to Which This Boat was Built

Your Malibu boat was built with the utmost care throughout the complete manufacturing process. The deck, hull, stringers and floor, as well as many accessory components, were built using our hand-laid composite fiberglass scheduling techniques. All boats receive complete quality control checks. Each boat is lake tested, and all information is kept on file at our factory for future reference.

Exemption Notice

This boat complies with U.S. Coast Guard safety standards in effect on the date of certification with the exception of certain fuel systems requirements associated with its fuel injected engine as authorized by U.S. Coast Guard Grant of Exemption (CGB-06-005). Maintenance of the fuel system in this boat should be performed only by Malibu trained certified technicians using identical fuel systems components.

Hull Identification Number (HIN)

Your Hull Identification Number can be found on the starboard transom of your boat below the rub rail. Federal law prohibits the tampering or removing of the number in any way. Use this number to register your boat with your local and state authorities.

US MB2GXXXXA001

Proposition 65**WARNING**

A wide variety of components used on this vessel contains or emits chemicals known to the state of California to cause cancer, birth defects and other reproductive harm.

EXAMPLES INCLUDE:

- Engine and generator exhaust
- Engine and generator fuel, and other liquids such as coolants and oil, especially used motor oil
- Cooking fuels
- Cleaners, paints and substances used for vessel repair
- Waste materials that result from wear of vessel components
- Lead from battery terminals and from other sources such as ballast or fishing sinkers

TO AVOID HARM:

- Keep away from engine, generator and cooking fuel exhaust fumes.
- Wash areas thoroughly with soap and water after handling the substances above.

Emission Control Warranty Information

The engine in your boat meets the strict requirements set forth by the California Air Resources Board (CARB). The engine has a special environmental tag and the boat has this label affixed to it. The tag and the label are required by the California Air Resources Board (CARB). The label has 1, 2, 3 or 4 stars. The label **MUST** be affixed to the boat, if the boat is operated in the state of California and/or bordering waters.

Chapter 1

BOATING SAFETY



At Malibu, safety is not an option!

Introduction

Congratulations on your purchase of a new high-performance recreational tow boat. Your Malibu boat has been constructed to meet and/or exceed all U.S. Coast Guard (USCG) and National Marine Manufacturers Association (NMMA) requirements applicable at the time of its manufacture. However, it is still your responsibility as the boat owner to ensure the boat is operated in a safe manner and is properly maintained.

Before operating this vessel, please take the time to get acquainted with the vessel and its various features and controls. We recommend that you carefully read and familiarize yourself with this Owner's Manual and all on-product safety labels prior to operating your new watercraft. This manual contains important information on Boating Safety, Boating Rules, Proper Operation and Maintenance of your boat, and you should consider it a permanent part of your vessel. In the event that this boat is sold, this manual should be included along with the boat to ensure that it will provide the same important information to the next owner.

About this Owner's Manual

The recommended practices and warnings in this manual represent sound advice for recreational boating and identify common risks encountered by boaters engaging in towed watersport activities. Read and understand the contents of this manual. Ask questions of a boating professional if anything in this manual does not make sense to you. The manual does not cover all instances of risk or danger, so please use common sense and good judgment when boating. If you follow the advice provided in this manual you will significantly reduce risk to yourself, your passengers, towed participants, and other boaters.

This manual is not intended to be a substitute for taking a course on boating safety nor is it a substitute for boating experience. It is recommended that if you are unfamiliar with the use and operation of a boat you seek advice and training from a qualified individual or organization. Check with your local marine law enforcement agency or dealer for more information about boating safety classes in your area.

The precautions listed in this manual and on the boat are not all-inclusive. If a procedure or method is not specifically recommended, YOU must be satisfied that it is safe for you and your passengers, and that the boat will not be damaged or made unsafe as a result of your decision. Remember - always use caution and common sense when operating and maintaining your boat!

Signal Words and Symbols Used In This Manual

Throughout this manual specific precautions and symbols identify safety-related information. You will find **DANGER**, **CAUTION**, **WARNING** and **NOTICE** symbols which require special attention. Please read them carefully and follow these precautions as indicated! They will explain how to avoid hazards that may endanger you, your passengers, towed participants, and other boaters. **PLEASE REVIEW ALL SAFETY INFORMATION.**



The Safety Alert symbol means Attention! Become Alert! Your Safety Is Involved!

DANGER



Indicates a hazardous situation which, if not avoided, will result in death or serious injury.

WARNING



Indicates a hazardous situation which, if not avoided, could result in death or serious injury.

CAUTION



Indicates a hazardous situation which, if not avoided, could result in minor or moderate injury.

NOTICE

Is used to address practices not related to physical injury.

Basic Safety Rules

Make sure you understand all of the operating instructions prior to attempting to operate this boat. Boating-related accidents are generally caused by the operator's failure to follow basic safety rules or written precautions. Most accidents can be avoided if the operator is completely familiar with the boat and its operation, follows recommended practices, and is able to recognize and avoid potentially hazardous situations.

*Past accident data shows that most **fatalities** involve actions which cause falls or ejections overboard, mishaps with towed persons, propeller strikes, collisions, and carbon monoxide exposure. Past accident data shows that most **injuries** are associated with collisions, mishaps with towed persons, falls or ejections overboard, being struck by the propeller, and fires and explosions. These incidents are mostly caused by operator inattention, operator inexperience, reckless operation, alcohol/drug use, excessive speed, passenger or towed person behavior, and violation of navigation rules.*

Failure to observe the safety recommendations contained in this manual may result in severe personal injury or death to you or to others. Use caution and common sense when operating your boat. Don't take unnecessary chances! Basic safety rules are outlined in this section of the manual.

Pre-operation Check List - Before Leaving the Dock

WARNING



Failure to follow these precautions may result in severe injury or death to you and/or others.

The operator shall:

- Check that weather conditions are safe for boating. It is the driver's responsibility to determine if weather or other factors have created an unsafe boating environment. Boaters must continuously be aware of weather conditions. Sudden storms, wind, water conditions, lightning, etc., can unexpectedly put boaters in grave danger. Always check the local weather report before going boating.
 - Check that drain plugs are securely in place.
 - Check bilge pump, horn, lights, blower and other equipment to verify they are operating properly.
 - Verify that the emergency cutoff switch lanyard is in proper operating condition and is properly affixed to the driver.
 - Check the operation of the steering system. Verify that the steering is operational before launching the boat. If the boat is already in the water, verify proper steering wheel operation at low speed. Turn the steering wheel full stop in both directions and verify proper rudder movement. Ensure that there is no binding or stiffness in the steering wheel rotation. Binding and stiffness is an indication that the steering cable needs replacement. Failure of the steering cable will result in loss of control of the boat.
-

- Ensure that the load of persons, ballast, and equipment is within the limits stated on the USCG Maximum Capacities Plate and is properly distributed based on instructions in this manual.
- Check that all safety equipment and life jackets, personal flotation devices (PFDs), and throwable cushions are in good condition and suitable for your boat and passenger load.
- Inform all passengers where safety equipment is located and how to use it.
- Have at least one other passenger who is capable of operating the boat safely in case of an emergency.

WARNING

Gasoline vapors can explode. Before starting engine operate blower for 4 minutes and check engine compartment bilge for gasoline vapors.

- It is very important to open the engine cover and check the engine compartment and bilge for liquid gasoline and gasoline vapors prior to each use of your boat and after refueling. Failure to do so may result in fire or explosion as well as serious injury or death to you and/or others.
- If you see liquid gasoline in the engine compartments/bilge or smell gasoline vapors, DO NOT attempt to start the engine. Liquid gasoline in the bilge is an extreme fire and explosion hazard which may cause injury or death. Find and fix the source of the leakage, remove the liquid gasoline from the bilge. Then ventilate the engine compartment/bilge and run the blower to remove all gasoline vapors before starting the engine.
- If gasoline vapors persist after running the blower, DO NOT attempt to start the engine. Likely, there is a gasoline leak that is creating the excessive vapor.
- Always operate blower below cruising speed and after stopping the boat.

Precautions While Underway**DANGER**

Failure to follow these precautions will result in serious injury or death.

The operator shall:

- Check that the area behind the boat is all clear before starting the engine to AVOID PROPELLER INJURY to persons in the water behind the boat or on the swim platform.
- Turn off the engine prior to anyone occupying the swim platform or being in the water behind the boat to AVOID PROPELLER INJURY. Being in neutral gear is insufficient; the propeller may still be turning, or engine may be inadvertently shifted into gear.
- Not back the boat toward persons in the water behind the boat to AVOID PROPELLER INJURY.
- Not allow people to be on or near the swim platform or in the water near the swim platform while the engine is running because CARBON MONOXIDE will exist around the back of the boat when the engine is running. Engine exhaust contains carbon monoxide, which is a deadly, odorless, colorless gas.

- Not operate the engine in a confined space or while tethered to another vessel as CARBON MONOXIDE will be around the boats.
- Not go under the boat cover with the engine running or shortly after the engine has been running because CARBON MONOXIDE may remain under the cover. Remove cover to ventilate the area.

WARNING

Failure to follow these precautions may result in severe injury or death to you and/or others.

The operator shall:

- Follow safe operating practices, the “Rules of the Road”, and the Watersports Responsibility Code.
- Not operate a boat if under the influence of alcohol or other drugs.
- Attach the emergency cutoff switch lanyard to yourself when operating the boat.
- Maintain a proper course and safe speed at all times to avoid collisions.
- Maintain a lookout for other boats, swimmers and obstructions in the water.
- Operate slowly in congested areas such as marinas and mooring areas.
- Keep a safe distance from other boats, swimmers, personal watercraft, docks, and fixed objects.
- Look before you turn/maneuver the boat so as to avoid potential collisions with oncoming or overtaking vessels.
- Be aware that this boat is a high-performance boat and is capable of quick, tight turns and changes in direction. Familiarize yourself with the handling characteristics of the boat. It is the operator’s responsibility to operate the boat in a manner that ensures the safety of all passengers. Abrupt maneuvers may result in the ejection of unsecured, unseated, or improperly positioned passengers. Verbally warn passengers before making quick, tight turns so they may have time to grasp a handrail, hand-hold, or portion of the boat.
- Be aware that your boat will handle differently depending on loading and on-board weight distribution.
- Ensure that all passengers are properly and securely seated in appropriate seating locations to avoid falling or falling overboard.
- Instruct and ensure that passengers remain properly seated at all times while the boat is in motion above idle speed.
- Not allow passengers to sit on the transom, seat backs, engine cover or sides of the boat while the engine is running and the boat is in motion to avoid falling overboard.
- Not allow passengers to sit in a position that obstructs the operator’s view.
- NEVER leave children unattended and in the boat without adult supervision.
- Have children riding in the bow of the boat be accompanied by an adult in the bow and ensure that all remain seated when the boat is in motion.
- Not let passengers occupy seats which may be in the path of the tow line.
- Slow down when crossing waves or wakes in order to minimize the impact on passengers and the boat. Crossing waves or wakes at an angle (such as 45 degrees) rather than perpendicularly will reduce the severity of the impact. Avoid rough water, large waves and large wakes from other boats when at high speed. Jumping waves/wakes or slamming the bow will cause large vertical impacts which may cause injury to occupants or cause ejections.

- For safe towing (waterskiing, tubing, wakeboarding, wake surfing, knee boarding, etc.) be experienced and have an observer [an observer or “spotter” is required by law in most states]. A rear view mirror is helpful if you are allowed to tow without an observer in your state.
- Avoid letting tow lines or mooring lines wrap around anyone’s body parts/limbs. Doing so could allow body parts/limbs to become entangled in the line and could cause significant injury, such as amputations.
- Keep track of tow lines and dock lines so that they do not become entangled in the propeller. A tow line will wrap quickly around a spinning propeller and is capable of immobilizing the boat and dragging a person entangled in the tow line underwater or causing amputations. Shut off the engine if a tow line has potential for wrapping in the propeller.
- The tower is designed to pull a limited number of individual(s), and in some cases only one (1) individual. Please consult the remainder of this manual and warning labels on the tower for details. **DO NOT** climb, sit on, stand on or jump/dive off of the tower. Tow line may loop on inverted tricks. **DO NOT** sit behind the pulling point of the tower.
- **NEVER** allow any type of spark or open flame on board. It may result in fire or explosion.
- Avoid grounding the boat: be familiar with local conditions and water depth. If you are uncertain, then proceed slowly with caution. Sudden groundings from planing speeds may cause rapid decelerations and cause occupants to impact the boat and/or to be ejected from the boat. Boat damage may also occur.
- Always watch for low obstacles such as tree limbs, bridges or power lines, especially in boats with tow towers.
- Seek shelter from open water if there is threat of lightning or severe weather.
- **NEVER** dive from the boat without being absolutely sure of the depth of the water. Severe injury or death may occur from striking the bottom or submerged objects. Striking the bottom or a submerged object while diving head first can cause paralysis, head injury or death.
- Provide assistance to other boaters in distress while ensuring the safety of your own passengers.
- When you leave the boat, take the keys with you. This will keep untrained and unauthorized persons from operating the boat. (This may not be applicable on some keyless ignition systems.)

Safety While Maintaining the Vessel

WARNING



Failure to follow these precautions may result in severe injury or death to you and/or others.

The operator shall:

- Visually inspect the engine compartment and ventilate after refueling.
 - Inspect fuel system regularly. Examine fuel tanks, hoses and fittings for leaks or corrosion at least annually because leaking fuel is a fire and explosion hazard.
 - Never remove or modify components of the fuel system in any way except for maintenance by qualified personnel. Tampering with fuel components may cause a hazardous condition which could lead to a fire or explosion.
 - Never override or modify the engine neutral starting safety switch in any way. Your boat engine should not start in gear. If it does, do not use the boat and have this safety feature fixed by an authorized dealer.
 - Be aware that batteries generate small amounts of dangerous hydrogen gas when charging. This gas is highly explosive. Keep all sparks, flames and smoking well away from the area. Failure to follow instructions when charging a battery may cause an explosion of the battery or the atmosphere near the battery, which could result in death or serious injury.
 - Keep the engine off whenever the engine box/cover/hatch is open. The engine box/cover/hatch serves as a machinery guard. Clothing or body parts can get caught in moving parts, causing death or serious injury. Keep away from moving parts.
 - Not replace your boat's marine parts with automotive parts or parts that were not designed for your boat.
 - Be aware that battery electrolyte fluid is dangerous. It contains sulfuric acid, which is poisonous, corrosive and caustic. If electrolyte fluid is spilled or placed on any part of the human body, immediately flush the area with large amounts of clean water and immediately seek medical attention.
 - Check the tightness of the tower bolts BEFORE each use. If a tower collapses it may result in injury to boat occupants or towed persons.
 - Not modify the tow bar. The tow pylon/bar is not designed for vertical extensions. Any modifications to the tow pylon/bar or its mountings may result in damage to the boat and injury to the user.
 - Only lift the boat from approved lift points, which are identified in later parts of the manual.
-

Owner Responsibility and Boating Education

Important Safety Information

Your safety, the safety of your passengers, and the safety of other boaters is dependent on how you operate and maintain your boat. As operator or owner of this boat, you are responsible for the safety of those with and around you while boating.

Responsibilities of Boat Owner and Operators

It is the owner's responsibility to ensure that the operator of the boat has been properly instructed in the lawful and safe operation of this vessel. Therefore, before operating the boat, thoroughly read this owner/operator manual. Be sure you understand each item before operating it. Improper operation or trailering of the boat could lead to severe personal injury or death. Improper operation or trailering of the boat may also damage the boat.

The operator and the boat owner assume all risks for themselves, their guests and anyone in proximity to their boat and ensure that all passengers understand the risks and responsibilities associated with boating.

This manual is not intended to provide complete training on all aspects of boat operation. We strongly recommend that all operators of this boat seek additional training on boat handling and safety. Have all operators become familiar with the handling characteristics, and proper steering and control system usage before attempting high-speed operation.

At the time of delivery, the owner/operator is responsible for:

- Understanding the warranty terms and conditions of your boat, your engine, and your trailer.
- Obtaining insurance.
- Examining the boat to ensure the proper operation of all systems.

Before operating the boat, the owner/operator is responsible for:

- Registering the boat as required in the jurisdiction where the boat is being operated.
- Providing the proper (USCG) safety equipment, and checking local, state and federal agencies as to laws and regulations (USCG carriage requirements).
- Carefully reading and understanding safety information and proper operating procedures within this manual.
- Obtaining other boating education if you lack operational experience.
- Familiarizing yourself with the navigable waters where you intend to operate the boat.
- Following the proper break-in procedure for the engine.

Registration

Federal Law requires that all motorboats be registered and that all motorcraft not documented by the U.S. Coast Guard display registration numbers. In nearly all states, this means registration with the designated state agency. In a few jurisdictions, the Coast Guard retains registration authority. Your dealer will either supply registration forms or tell you where they may be obtained. The agency will supply you with a certificate which must be carried with you when the boat is in operation. International laws may vary as to required registration.

Insurance

The boat owner may be legally responsible for damages or injuries caused by both himself and the operator (if different than the owner). Common sense dictates that you carry adequate personal liability and property damage insurance on your boat, just as you would on your automobile. Many states have laws detailing minimum insurance needs. Your insurance agent or your dealer may be able to supply you with more information. You should also protect your boat from physical damage or theft.

Boating Safety Education Opportunities

It is recommended that the boat owner/operator obtain boater safety education. If you have never owned a boat before, you can get an excellent introduction to boat handling from organizations such as the U.S. Coast Guard, American Red Cross, United States Coast Guard Auxiliary, or your local boating authority. Even if you are a veteran boater, these courses will help sharpen your boating skills as well as bring you up to date on current rules and regulations. See your local boating agency or dealer for information on classes in your area.

Some states require youths, 16 years of age and younger, to complete a boating safety course before operating any watercraft. Many others require operators under the age of 18 to be licensed in small boat operation. Boat smart from the start: take a boating safety course and get a free vessel safety check annually for your boat. For more information, contact: United States Coast Guard Auxiliary, www.cgaux.org; United States Power Squadrons, 1-888-FOR-USPS, www.usps.org.

The following is a list of some other agencies and organizations that offer Water Safety, First Aid and CPR courses or information. To find boating safety courses in your area, call your state's local boating agency or the USCG boating safety course line at 1-800-336-2628 (1-800-245-2628 in Virginia).

- USCG Office of Boating (www.uscgboating.org)
 - American Red Cross (www.redcross.org)
 - U.S. Coast Guard Auxiliary (www.cgaux.org)
 - U.S. Power Squadrons (www.usps.org)
 - State Boating Offices
 - Canadian Power and Sail Squadrons (www.cps-ecp.ca)
 - Boat Owners Association of the United States (www.boatus.com)
 - National Safe Boating Council (www.safeboatingcouncil.org)
 - Water Sports Industry Association (www.wsia.net)
 - European or international organizations
-

Operation by Minors and Licensing

If your boat will be operated by a minor, remember to have an adult present at all times. Many states have laws regarding minimum age and licensing requirements for minors. Some states require boat training courses, certification, or licensing for minors and/or adults. Contact state and local authorities for requirements that apply in your area.

Safety and Required Equipment

Your boat and equipment must be in compliance with federal, state and local safety equipment regulations. USCG regulations require certain safety equipment be present on your boat during operation. For a detailed description, obtain “Federal Requirements for Recreational Boats” published by the U.S. Coast Guard and available online at:

http://www.uscgboating.org/regulations/federal_requirements_brochure.aspx.

In addition to the USCG regulations, other local and/or international law enforcement agencies may have similar requirements. You should check with your local marine law enforcement agency regarding any such requirements before boating.

Equipment requirements for coastal and inland waters differ. Check with local authorities and/or the USCG for further information about coastal water requirements.

The Federal Boat Safety Act of 1971 (FBSA/71) and the National Recreation Boating Safety Program have established minimum safety standards for boats and associated equipment, specified by the USCG. In addition, the American Boat and Yacht Council (ABYC) and the National Marine Manufacturers Association (NMMA) work with boat builders to develop voluntary standards that exceed the USCG requirements. The included safety equipment on your boat meets or exceeds the standards of the USCG, ABYC and the NMMA.

Some required safety equipment, such as life jackets (PFDs), are not included with your boat. Your dealer can help you choose the appropriate equipment.

NOTICE *Many states' equipment requirements go beyond USCG requirements. Contact your state boating office for further information.*

Navigation Lights

Your boat is equipped with navigational lights. Recreational boats are required to display navigational lights between sunset and sunrise and other periods of reduced visibility (fog, rain, haze, etc.). Navigation lights are provided to keep other boats informed of your presence and course. It is up to you to make sure they are operational, displayed correctly, and turned on when required.

Emergency Safety Lanyard

Your boat is equipped with an Emergency Safety Lanyard (cutoff switch). We recommend that the lanyard be secured to the operator and the lock plate attached to the emergency cutoff switch prior to starting the engine and anytime the engine is operating. The Emergency Safety Lanyard is designed to turn off the engine whenever the operator moves far enough away from the helm to activate the switch. The purpose is to stop the engine, propeller, and boat in the event the operator leaves the helm location, falls overboard, or is ejected from the boat. If the engine is stopped it will prevent the boat from becoming a run-away, unmanned boat, which may cause injury or death to boat occupants who have fallen overboard or been ejected, or to other nearby people. If the engine stops it will minimize the subsequent opportunity for propeller contact with the operator or other persons in the water. If the engine and boat stop it will afford opportunity for the operator or other persons who have fallen overboard to safely re-board the boat.

WARNING



It is recommended that you use the Emergency Safety Lanyard system as failure to do so can cause death or serious injury.

DO NOT operate the boat if the Emergency Safety Lanyard system does not function properly.

- Attach the Emergency Safety Lanyard to a secure place on your clothing, your arm or your leg while operating.
- DO NOT attach the lanyard to clothing that could tear loose.
- DO NOT route the lanyard where it could become entangled, preventing it from functioning.
- Avoid accidentally pulling the lanyard during normal operation.
- Loss of engine power means loss of most steering control.
- Without engine power, the boat will decelerate rapidly. This could cause people in the boat to be thrown forward or ejected overboard if they are not properly seated in the boat.

There are practical limitations to what the Emergency Safety Lanyard can do. It can take several seconds for the engine and propeller to stop turning. The boat can continue to coast for several hundred feet depending on the boat speed at the time the switch is activated. While the boat is coasting, it can cause injury to anyone in its path. Accidental loss of power can be hazardous particularly when docking or in heavy seas, strong current, or high winds.

While at the dock or when the boat is not moving, periodically disconnect/pull the Emergency Safety Lanyard out of the switch while the engine is running to test for proper operation. The engine should shut off when the lanyard is disconnected/pulled from the switch. You should not be able to restart the engine until the lanyard is back in place.

Personal Flotation Devices

Federal law requires that you have at least one wearable Personal Flotation Device (PFD) of the proper size (Type I, II, III or V), for each person on board or being towed, and at least one throwable PFD (Type IV) in the boat. PFDs must be Coast Guard approved, in good and serviceable condition and the appropriate size for the user. To meet requirements, each lifesaving device must have a current, legible USCG approval stamp permanently affixed. At the beginning of each season, inspect life jackets (PFDs) for damage and test for proper flotation. Refer to the lifejacket (PFD) manufacturer's information.

REMEMBER- The best PFD is the one that is worn – that is, the one that can save your life. PFDs are intended to save lives; it is highly recommended that you and your passengers wear them while in the boat. Learn how to use them and adjust as necessary for comfort. *It is especially important that children and non-swimmers wear a life jacket (PFD) at all times.* Make certain all passengers know where life jackets are located, how to put on and properly adjust their life jackets (PFDs), and that life jackets are readily accessible at all times.

Your dealer can help you select appropriate life jackets (PFDs) and throwable lifesaving devices for your area. Some PFDs are specially made for use while waterskiing or wakeboarding and are not U.S.C.G. approved. Please check local law with respect to their use. Some states require children to wear a PFD at all times. There are four types of wearable PFDs (Type I, II, III or V) and one throwable type of PFD (Type IV) used for throwing in emergency situations. Examples of these USCG approved PFDs are shown:



Type I PFD – Offshore Lifejacket: This PFD is designed for extended survival in rough, open water. It usually will turn an unconscious person face up and has over 22 pounds of buoyancy. This is the best PFD to keep you afloat in remote regions where rescue may be slow in coming.



Type II PFD – Near Shore Buoyant Vest: This “classic” PFD comes in several sizes for adults and children and is for calm inland water where there is chance of fast rescue. It is less bulky and less expensive than a Type I, and many will turn an unconscious person face-up in the water.



Type III PFD - Flotation Aid: These life jackets are generally considered the most comfortable, with styles for different boating activities and sports. They are for use in calm water where there is good chance of fast rescue since they will generally not turn an unconscious person face-up. Flotation aids come in many sizes and styles.



Type IV Throwable Device: These are designed to be thrown to a person in the water. Throwable devices include boat cushions, ring buoys, and horseshoe buoys. They are not designed to be worn and must be supplemented by wearable PFD. It is important to keep these devices immediately available for emergencies.



Type V PFD - Special Use Device: Special use PFDs include work vests, deck suits, and hybrids for restricted use. Hybrid vests contain some internal buoyancy and are inflatable to provide additional flotation. These PFDs may be used instead of a Type I, II, or III PFD with non-towed participants if used in accordance with the approval conditions on the label and if worn when the boat is underway. Some Type V PFDs provide increased protection against hypothermia.

NOTICE

A Type V PFD must be worn to be counted toward the minimum carriage requirements.

NOTICE

Special lifejackets are available for skiing and other water sports. These non-Coast Guard approved lifejackets do not count as PFD's.

Fire Extinguisher

A portable fire extinguisher is required if your boat has an inboard engine, or when fuel is stored in closed stowage compartments.

Approved fire extinguishers are classified by a letter symbol, either B-I or B-II with the B designating that the material will extinguish flammable liquids such as gasoline, oil, etc. B-I extinguishers are required for boats less than 26 feet in length. Check periodically to ensure that the extinguisher is in working condition and fully charged. Check local, state and federal agencies as to laws and regulations.



Horn or Whistle

All boats over 16 feet (4.8 meters) in length must be equipped with an operable horn or whistle. Test the operation of the horn periodically, so as to make sure it will sound when you actually need to alert someone or another boat. The following are standard signals when using a whistle or a horn:

- One prolonged blast: Warning.
- One short blast: Pass on my port (left) side.
- Two short blasts: Pass on my starboard (right) side.
- Three short blasts: My engines are in reverse.
- Five or more blasts: Danger!

Bilge Pump(s)

Bilge pump(s) are installed in your boat to remove water that may accumulate in the bilge. Know the location of the pump(s), where they discharge, and where switches are located. Typically there are manual switch and/or an automatic switch position(s). Periodically test the operation of bilge pumps by activating the manual switch and observing the water discharge. It is best to leave the bilge pump switches in automatic mode, so as to not allow excess water to unknowingly accumulate in the bilge of your boat. If your bilge pump comes on too frequently or continuously, investigate the source of leaking water (check for hull damage, hose or piping leaks, missing drain plug, exhaust system or ballast system failures, etc.), and/or return to shore. Excess water in the bilge of your boat can cause loss of engine power, sinking, and/or capsizing.

Visual Distress Signals

All vessels used on coastal waters, the Great Lakes, territorial seas, and those waters connected directly to them up to a point where a body of water is greater than two miles wide, must be equipped with USCG approved visual distress signals. Your dealer or local authorities can help you select appropriate visual distress signals for your area.

If you are required to carry distress signals, you must have three USCG approved pyrotechnic devices. Be sure they are in serviceable condition, not exceeding the expiration date and stored in a cool, dry location in a red or orange waterproof container.

WARNING



Pyrotechnic signaling devices can cause fire and / or explosion, death, serious injury, and property damage if improperly handled. Follow the pyrotechnic manufacturer's directions.

Recommended Safety Equipment

As a precaution, a prudent boater will avoid potential problems on an outing by having additional equipment on board. Normally, this equipment is dependent on the size and type of the body of water and the length of the trip. Your dealer can assist you in acquiring this additional equipment.

We recommend the following equipment:

- First aid kit and manual
- Anchor with at least 75 feet (23 meters) of line
- Mooring lines and fenders
- Bailing device (bucket, hand pump)
- Combination paddle/boat hook
- Local charts and compass
- Day/night distress signals
- Waterproof flashlight and spare batteries
- Cellular phone
- Waterproof container for cell phone
- GPS Global Positioning System
- Binoculars
- Portable AM/FM radio with weather band
- A non-electric horn or whistle
- Extra engine oil
- Tool kit
- Spare propeller and mounting hardware
- Spare fuses
- Spare keys
- Sunglasses and sun block lotion



General Boating Safety Topics

Safe Speed

Navigation rules state that a boat be operated at a safe speed at all times. Determination of a safe speed involves consideration of many factors, such as, but not limited to:

- Boating activity (tubing, water skiing, wakeboarding, wake surfing, etc.)
- Boat traffic congestion
- Water conditions
- Environmental conditions (shore line, docks, and depth of water)
- Weather
- Visibility

The boat should not be driven at a rate of speed faster than will allow it to be brought to a full stop within the operator's field of view given the environmental conditions at the time. Safe speed for the conditions and driver attention (lookout) are important factors in avoiding collisions which may cause injury or death. When in doubt it is prudent to slow down within adequate time and distance so as to be able to assess the conditions and paths of other boats.

It is important to know the Rules of the Road, although do not assume that all boaters also know the rules or that they will abide by them. Avoid collisions by constantly assessing the ever-changing situation and be sure to make appropriate speed and course changes early.

Passenger Safety

The operator of the boat is responsible for the safety of the passengers, all skiers/riders, as well as his/her own safety. Ensure that you and your passengers adhere to these safety recommendations:

- Any time you take your boat out, make sure that there is at least one other passenger aboard who is familiar with the operation of your boat.
- Ensure that all passengers are properly and securely seated in appropriate seating locations to avoid falling or falling overboard.
- While the engine is running, and while the boat maneuvering, all occupants should be properly seated. **DO NOT** stand while the boat is moving.
- **DO NOT** sit on the engine box, seat backs, transom seating, sunpad, boarding platform or gunnels while the boat is underway. You could fall overboard and be hit by the propeller, or another boat.
- **DO NOT** allow objects, arms or legs, or any other body parts to hang over the bow or gunnels. Stay within the boat.
- Passengers should not sit in locations that obstruct the operator's visibility.
- Persons and gear should be stowed in a way that distributes weight appropriately and in a manner that trims the boat properly (pitch angle). Excessive weight at either the bow or the stern relative to one another can cause trim problems leading to reduced driver visibility, erratic steering, loss of control, or bow submergence and flooding/swamping.

- Passengers should be well aware of emergency equipment and instructed in its use.
- Passengers should assist with lookout duties and notify the operator of any approaching watercraft or potentially unsafe conditions to provide assistance with collision avoidance.

Recommended Seating Chart

20 MXZ
13 TOTAL CAPACITY



20 VTX
11 TOTAL CAPACITY



21 RIDE
13 TOTAL CAPACITY



21 VLX
13 TOTAL CAPACITY



22 MXZ
15 TOTAL CAPACITY



23 LSV
15 TOTAL CAPACITY



24 MXZ
18 TOTAL CAPACITY



247 LSV
17 TOTAL CAPACITY



RESPONSE TXI
9 TOTAL CAPACITY



Carbon Monoxide Safety

Carbon Monoxide (CO) is a deadly, colorless and odorless gas produced by all engines and fuel burning appliances. Even with the best boat design and construction, plus the utmost care in inspection, operation and maintenance, hazardous levels of carbon monoxide may be present in or near the boat under certain conditions. The boat owner, operator, as well as all boat occupants, must understand the dangers of carbon monoxide and must comply with all safety recommendations/requirements. For boats with cabins, always ventilate the boat interior and avoid boating situations which cause increased exposure.

DANGER



Carbon monoxide (CO) can cause brain damage or death.

Engine and generator exhaust contains odorless and colorless carbon monoxide gas.

Carbon monoxide will be around the back of the boat when engines or generators are running.

Move to fresh air, if you feel nausea, headache, dizziness, or drowsiness.

- Do not allow people to be on or near the swim platform or in the water near the swim platform while the engine is running. Carbon monoxide will exist around the back of the boat when engines are running.
- Do not operate the engine in a confined space or while the boat is tethered to another vessel.

- Do not go under the boat cover while the engine is running or shortly after the engine has been running. Carbon monoxide may be trapped under the cover. It is important to remove the cover and/or ventilate the area before going under the boat cover.
- Do not “platform/teak” surf or platform drag. Carbon monoxide will exist in high concentrations in the vicinity of the swim platform near the water while the engine is running. The USCG has deemed platform dragging as a dangerous and hazardous activity which should be prohibited, as it can result in injury or death.
- In the event that someone exhibits the symptoms of carbon monoxide exposure (nausea, headache, dizziness, or drowsiness), have them breathe fresh air and, if necessary, immediately seek medical attention.

Hazardous boating situations involving carbon monoxide include:

Blockage of boat exhaust by obstruction.

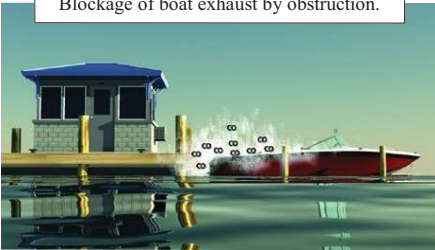

Exhaust traveling along obstruction.



Operating at slow speed or while dead in the water.

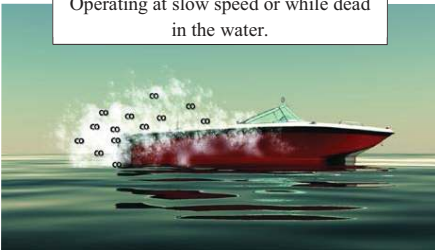

Operating with high bow angle.

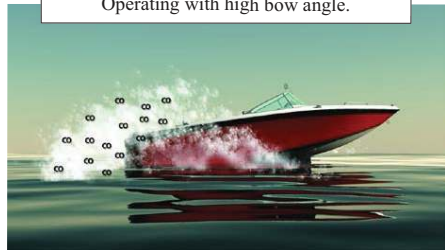

Exhausts from other vessels in confined areas.

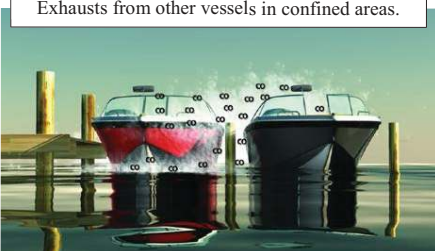

Operating with canvas tops and side curtains in place without ventilation.

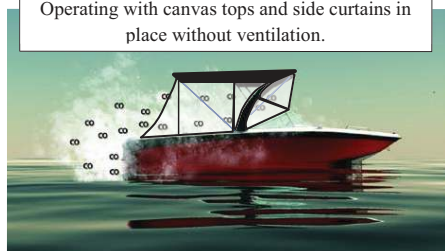

For the most current information on carbon monoxide, you may call, write or visit on-line any of the following:

United States Coast Guard Office of Boating Safety (CG-5422)
2100 Second Street SW STOP 7581,
Washington, DC 20593-7581
1-800-368-5647 www.uscgboating.org
(www.uscgboating.org/safety/carbon_monoxide.aspx)

NMMA
National Marine Manufacturers Association\
231 S. LaSalle St., Suite 2050, Chicago, IL 60604
312-946-6200 www.nmma.org

American Boat & Yacht Council, Inc.
613 Third St., Suite 10, Annapolis, MD 21403
410-956-4460 www.abycinc.org

Proper Loading

WARNING



DO NOT overload your boat.

Overloading or uneven loading can cause loss of control, capsizing, or swamping, which may lead to death or serious injury.

Adhere to the load capacity plate restrictions, and always account for persons, gear, and all non-factory-installed ballast or other equipment.

Your boat is equipped with a maximum load capacity plate indicating the maximum acceptable load as determined by the manufacturer following certain Federal guidelines. In addition to following these weight guidelines, it is critical that you properly distribute this weight throughout the boat. If too much weight is placed in one area it can have serious impact on the boat's handling and control, which has the potential to lead to injury or death.

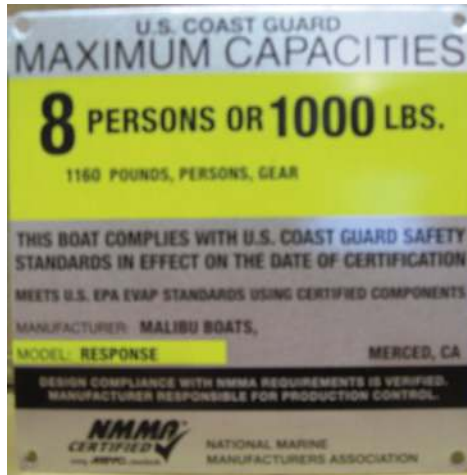

The load capacity plate is used by boat manufacturers participating in the National Marine Manufacturers Association certification program. Your manufacturer has submitted your model for inspection and compliance with their guidelines. The maximum number of persons allowed on the boat has been determined by the manufacturer and displayed on the capacity plate. This information on the capacity plate applies under normal conditions and special care must be used in any abnormal conditions. Check the capacity plate on your boat and abide by these limits.

The capacity plate has the following information permanently printed on it:

- The total weight of persons, gear and other items which the boat is capable of carrying under normal conditions. This weight must include any added ballast above and beyond boat manufacturer's factory installed ballast system(s).

WARNING | ***Any non-factory installed ballast must be properly secured to prevent injury.***



WARNING | ***Do not fill the bilge area with water. Excessive water in the bilge can cause changes in boat trim and reduce boat stability which may lead to submergence or capsize.***



Weighting Your Boat During Watersport Activities

Although water intrusion and waves spilling inside a boat is an obvious boating hazard, this hazard can be increased when weighting your boat for water sports such as wakeboarding or wakesurfing. As wakeboarding has evolved, ballast systems have been developed to add weight and increase the size of the wake. The simplest ballast system on the market is the water ballast type, such as the “FAT SAC.” The quest for the largest wake has caused some boat operators to excessively overload their boats. It is not uncommon to see operators use aftermarket ballast systems and then put additional people and gear in their boat. Be advised that this practice can lead to overloading your boat which may lead to any of the following: changes in handling and performance; capsizing, flooding, and sinking; boat occupants going overboard. **Do not overload your boat.**

Always be aware of the load in your boat and do not load the boat in excess of the listed capacity. Each boat has a maximum capacity label displaying the maximum weight of people, gear and ballast that can be placed in the boat.

When loading your boat, give attention to the effect that the load distribution has on the boat’s trim angle. Trim angle is the technical term for the up or down pitch angle of your boat (also known as the “bow up” or “bow down” angle). The fore and aft load distribution of weight, passenger, and gear can affect the running trim angle of the boat.

- Excessive weight placed in the stern of the boat can cause the inability to get on plane, high bow up angles, and can lead to steering difficulties. High bow up angles can be dangerous due to the reduction in the operator’s forward visibility which can lead to collisions and groundings. High bow up angles cause longer transition times from displacement mode (slow velocity, 0 to 5 mph) to planing speeds (18 to 20 mph and above). During transition, it is important that the boat operator pays attention so that they are able to see forward and that the time in transition (or in the “hump” speed region) is minimized.
- Excessive weight placed in the bow of the boat can lead to very flat planing trim angles which may lead the boat to turn aggressively, unpredictably, and without steer input. The phenomenon of yaw instability is caused by heavy bow weights and running very flat (bow down or flat trim angles). This can occur with excessive weight in the bow compared to weight in the stern of the boat. Another ill effect of too much bow weight in comparison to stern weight is that with extremely heavy bow loads, the boat’s bow may dive or submerge when coming off plane (decelerating rapidly, or encountering waves/wakes at slow speed). If the bow submerges, then water will enter and flood your boat.
 - When encountering conditions which may lead to bow diving or bow submergence, it is recommended to accelerate the boat before the wave/wake in order to help raise the bow and get over the wave/wake.
 - If the bow submerges, the recommended action is to reduce throttle to stop forward speed, get passengers to move aft, and turn on the bilge pump.

It is the boat operator’s responsibility to tell passengers to move to other seats on the boat, so as to not overload the stern or bow of the boat, nor restrict the boat operator’s forward visibility. There is no single recommended seating or load distribution for all conditions. Experience with your boat will allow you to determine where to properly allow passengers and gear to be placed.

WARNING

Excess and improper loading of bow area forward of windshield may cause water influx, operating instability, and loss of control resulting in injury or death.

Bow Capacity Limit – X persons or XXX lbs. person, gear and ballast. This is posted separately on your boat but still included in overall capacity.

Use good judgment when weighting your boat for any towed water sports.

Visibility of the Operator

The operator of the boat is responsible, by law, to “maintain a proper lookout by sight and hearing.” The operator must ensure that he/she has appropriate visibility for safe operation. No passengers or equipment should block the operator’s view, including the view of other boats, skier(s), rider(s), swimmer(s), or anyone or anything else in the water. Even momentary interference can result in the driver’s inability to respond to a situation that requires avoidance of another vessel or submerged or partially-submerged object(s).

Look carefully before turning, especially when you are turning around to pick up a fallen skier/rider. Other boats in your vicinity may not necessarily be following the “Rules of the Road.” Be alert and keep a visual check for other boats in and around your intended path. Do not turn or maneuver your boat without first checking that it is clear to do so. Failure to look before turning can result in an encounter with another boat where neither boat has enough time to avoid a collision. This situation can develop very quickly if you fail to look first and turn in front of another oncoming boat.

WARNING

Obstructed visibility can cause death or serious injury. The operator must maintain clear visibility at all times while operating the boat.

Arrange passengers and equipment appropriately or designate a passenger to assist when visibility is limited.

Boating Under the Influence

WARNING

Operating a boat or boating under the influence of alcohol and/or drugs can cause serious injury or death.

Alcohol and drugs slow your reaction time and impair your judgment.

Do not operate a boat or allow passengers to boat while under the influence of alcohol and/or drugs.

Boating under the influence of alcohol or drugs can be deadly. Alcohol and/or drug use is the leading contributing factor to all recreational boating fatalities. Alcohol and drugs can increase your reaction time and impair your judgment. Combined with the sun, wind, waves, and noise of other watercraft, the effects of drugs and alcohol can be increased and can significantly increase your reaction time. As the owner/operator, you are responsible for the alcohol/drug use and onboard behavior of your passengers. Additionally, civil lawsuits in cases of property damage or injury/death to others can result in significantly higher verdicts when alcohol or drugs are allowed.

WARNING

Impaired operation may result in severe personal injury or death.

Federal and state laws prohibit operating a boat under the influence of alcohol and other drugs.

If the operator's blood alcohol content is above the legal limit, violators are subject to fines and may go to jail. Violators may also lose automobile driving privileges.

Product Misuse

Misuse of the product or use of it in a manner for which it was never intended can create dangerous situations. The boat operator and passengers are responsible for using the product safely and as intended. The driver must operate the boat in a manner that ensures the safety of all passengers. If you or your passengers are unsure about the proper use of the product, unsure about performing certain boating maneuvers or are unsure about a particular water activity, refer to this manual or contact a knowledgeable source, such as your local dealer, the US Coast Guard, or your local boating authority.

Reporting Accidents

Boat operators may be required by law to file a Boating Accident report with their state boating law enforcement agency or local authority, the USCG, or their country's boating law enforcement agency when their boat is involved in certain boating accidents. A boating accident must be reported if there is a loss or probable loss of life or a personal injury requiring medical attention beyond first aid. In these situations, a formal report must generally be filed within 48 hours of the accident. Also a boating accident must be reported for accidents when damage exceeding \$500 is incurred, or there is a complete

loss of the boat. In these situations, a formal report must generally be filed within 10 days. If any of these events occur, seek further assistance from local law enforcement personnel. Please note that the submittal of a report is the responsibility of the boat owner. This requirement is different than laws associated with the reporting of automobile accidents.

Rendering Assistance

If you see a distress signal or suspect a boat is in trouble, you must assume it is a real emergency and render assistance immediately. By law, the operator in charge of the craft is obligated to provide assistance to any individual in danger, presuming assistance can be safely provided. Failure to render assistance can result in a fine and/or imprisonment. The 1971 Boating Safety Act grants protection to a “Good Samaritan” boater providing good faith assistance, and absolves a boater from any civil liability arising from such assistance.

Hazardous Conditions

Every waterway poses hazards that should be avoided. You will be best prepared to avoid these hazards if you are familiar with the waterway where you are boating. Whenever possible familiarize yourself with navigation charts, depth charts, and waterway maps before you go boating. The following information outlines some of the most common hazards which may be encountered:

Shallow Water Operation

Shallow water brings on obvious hazards such as sand bars, stumps, rocks, etc. Know the area in which you will be operating the boat. Grounding the vessel or striking submerged objects can result in serious injury or death and can cause severe damage to your watercraft. At high speed, this can cause rapid deceleration or stop your boat abruptly, which may cause occupants to impact the interior of the boat or be ejected. Stick to deeper water whenever possible, and if you must travel in shallow water, proceed at low speed and post a lookout.

Know the minimal depth your boat can safely travel.

Warning Markers

Learn to recognize the different buoys and day markers; they are used as the signposts of the waterways identifying navigable routes and water hazards. It is a good idea to ask local authorities about hazard areas and if they are marked. Stay within boundaries and clear of hazards.

Weeds

Weeds can generally be a threat to a boat’s engine and other components on the boat. If weeds wrap around the propeller, they can create vibration in the engine. They also can restrict water intakes or clog the water filter causing the engine to overheat. Learn to recognize the typical normal operating temperature range for your engine. If temperature rises high above normal, then check for blockage of the engine cooling water system.

NOTICE *Weeds can sometimes be removed by shifting to NEUTRAL, pausing for a moment, then shifting to REVERSE to unwind the weeds from the propeller.*

Dam Spillways

The area around dam spillways is very hazardous and conditions can change rapidly. Keep clear of the spillways and areas below dams. Currents created by spillways can draw in objects, including your boat.

Restricted Areas

Before boating, check with Local, State, and Federal authorities to identify restricted areas. Because of the threat of terrorism, the U.S. Coast Guard has and will continue to implement strict limits on watercraft near U.S. Navy and Coast Guard ships and other potential targets.

Weather/Seas

Learn and understand weather patterns and signs of change. Bad weather can cause an uncomfortable and unsafe situation. If a storm approaches, seek a safe harbor. Check forecasts before getting underway and continue to monitor conditions while on the water.

Environmental Concerns

As a boater, you already appreciate nature's beauty and the peace of the great outdoors. It is a boater's responsibility to protect the natural environment by keeping waterways clean.

Foreign Species

If you trailer your boat from lake to lake, you have the potential of unknowingly introducing a foreign aquatic species from one lake to the next. It is important to thoroughly clean the bottom of the boat below the water line, remove all weeds and algae, and drain the bilge, ballast, and livewells before launching the boat in a new body of water. Check local, state, country agencies as to laws and regulations.

Fuel/Oil Spillage

The spilling of fuel or oil into our waterways contaminates the environment and is dangerous to wildlife. DO NOT EVER discharge or dispose of fuel, oil or other chemicals into the water; it is prohibited and can result in fines. These are three common, accidental types of discharge:

- During initial fueling of a nearly empty tank
 - Overfilling the fuel tanks
 - Pumping contaminated bilge water
-

WARNING

Fumes from rags can collect in bilge and pose an extremely hazardous fire and explosion risk, which can result in injury or death.

Never store rags used to wipe up fuel or solvent spills in the boat.

Dispose of rags properly ashore.

Discharge/Disposal of Waste

Waste means all forms of garbage, plastics, recyclables, food, wood, detergents, sewerage and even fish parts in certain waters – in short, nearly everything. We recommend you bring back everything you take out with you for proper disposal ashore.

Excessive Noise

Noise means engine noise, radio noise, loud conversation, or even yelling. Many bodies of water have adopted noise limits. Noise can carry a considerable distance on water, especially at night. Be sure to follow regulations and be courteous.

Speed/ Wake/Wash

Be alert for NO WAKE zones. You are responsible for any damage or injury caused by your wake/wash. Prior to entering a NO WAKE zone, reduce throttle, come off plane to the slowest steerable speed. Use caution when operating around smaller crafts, in channels and marinas, and in congested areas.

Some states and boating areas have imposed speed limits for the operation of boats, including, but not limited to, no-wake zones. Check local, state, and federal agencies as to laws and regulations. The U.S. Coast Guard and local boating authorities are excellent sources for this information, which can include penalties for failure to observe the requirements.

Exhaust Emissions

Increased exhaust (hydrocarbon) emissions pollute our water and air. Keep your engine tuned and boat hull clean for peak performance. Consult your Malibu dealer for information.

Paints

If your boat is kept in water where marine growth is a problem, the use of anti-fouling paint may reduce the growth rate. Be aware of environmental regulations that may govern your paint choice. Contact your local boating authorities for information.

Cleaning Agents

Household cleaners should be used sparingly and not discharged into waterways. Never mix cleaners and be sure to use plenty of ventilation in enclosed areas while cleaning your boat. **DO NOT** use products which contain phosphates, chlorine, solvents, non-biodegradable or petroleum based products. Refer to **CARE AND MAINTENANCE** in this manual for more information.

MARPOL Treaty

The USCG enforces the International Convention for the Prevention of Pollution from ships, commonly referred to as the MARPOL Treaty (Marine Pollution). This treaty prohibits the overboard dumping of all ship-generated plastics, chemicals, garbage and oil.

On Product Warning Labels

Warning Labels & Locations

Warning labels are placed at specific locations on your Malibu boat at the time of manufacture to alert you to potential hazards that may not be obvious. These labels also indicate how to avoid these hazards. Warning labels should never be removed and must remain legible. If you suspect a label is missing, or if a label becomes damaged or becomes unreadable (damaged, faded, or sun bleached), contact your dealer for replacement.

It is the responsibility of the boat owner and occupants of the boat to understand and comply with all warning labels and safety recommendations/requirements. The driver of the boat and the boat owner are responsible for the proper operation of the boat and the safety of the occupants of the boat. Failure to adhere to and comply with the on-product warning labels and safety statements labeled as dangers, warnings, and cautions that appear in this manual can lead to serious injury, or death, as well as property damage. **READ AND ADHERE TO ALL WARNING PLATES AND LABELS** from bow to stern, including those that are installed inside the engine compartment, lockers, and underneath seating.

Warning Labels

Warning labels are displayed at various locations throughout your new Malibu to point out safety hazards. It is important that you take the time to locate these labels. Do not remove or cover warning labels. Replace when illegible.

WARNING! WARNING! WARNING!

MALIBU BOATS' PATENTED "SWIVEL-HEAD" SKI PYLON IS DESIGNED FOR NORMAL WATERSKIING ACTIVITIES: SLALOM, JUMP, KNEEBOARDING, TRICKS, AND BAREFOOTING. ANY OTHER USES SUCH AS PARA-SAILING, KITE FLYING, TOWING PYRAMIDS OF SKIERS, ETC., MAY OVERSTRESS THE PYLON AND POSSIBLY CAUSE PERSONAL INJURY AND/OR EQUIPMENT DAMAGE.

1

WARNING

GASOLINE VAPORS CAN EXPLODE. BEFORE STARTING ENGINE, OPERATE BLOWER 4 MIN. AND CHECK ENGINE COMPARTMENTS FOR GASOLINE LEAKS OR VAPORS. RUN BLOWER BELOW CRUISING SPEED.

2

WARNING

LEAKING FUEL IS A FIRE AND EXPLOSION HAZARD. INSPECT SYSTEM REGULARLY. EXAMINE FUEL TANKS FOR LEAKS OR CORROSION AT LEAST ANNUALLY.

3

DANGER

Swim platform should not be used when engine is running.

4

EXEMPTION NOTICE

"THIS BOAT COMPLIES WITH U.S. COAST GUARD SAFETY STANDARDS IN EFFECT ON THE DATE OF CERTIFICATION WITH THE EXCEPTION OF CERTAIN FUEL SYSTEMS REQUIREMENTS ASSOCIATED WITH ITS FUEL INJECTED ENGINE AS AUTHORIZED BY U.S. COAST GUARD GRANT OF EXEMPTION (CGB-06-005). MAINTENANCE OF THE FUEL SYSTEM IN THIS BOAT SHOULD BE PERFORMED ONLY BY MALIBU TRAINED CERTIFIED TECHNICIANS USING IDENTICAL FUEL SYSTEM COMPONENTS."

5

WARNING!

SERVICE OF THE ENGINE ON THIS BOAT REQUIRES SPECIAL TOOLS, TRAINING AND GENUINE REPLACEMENT PARTS WHICH ARE ONLY AVAILABLE FROM MALIBU BOATS COMPANY. THE FUEL SYSTEM SHOULD BE SERVICED ONLY BY A MALIBU TRAINED CERTIFIED TECHNICIAN. DO NOT ATTEMPT TO SERVICE THE SYSTEM YOURSELF.

6

WARNING

Carbon monoxide (CO) can cause brain damage or death. Engine and generator exhaust contains odorous and colorless carbon monoxide gas. Signs of carbon monoxide poisoning include nausea, headache, dizziness, drowsiness, and lack of consciousness. Get fresh air if anyone shows signs of carbon monoxide poisoning. See Owner's Manual for information regarding carbon monoxide poisoning.

WARNING

ROTATING PROPELLER MAY CAUSE SERIOUS INJURY OR DEATH. SHUT OFF ENGINE WHEN NEAR PERSONS IN THE WATER.

WARNING

AVOID SERIOUS INJURY OR DEATH FROM FIRE OR EXPLOSION RESULTING FROM LEAKING FUEL. INSPECT SYSTEM FOR LEAKS AT **LEAST ONCE A YEAR.**

7

WARNING

Do not tow other vessels with this tower. Improper use of this tower can be hazardous and could result in serious injury or death. Ensure all bolts are tight before each use

8

BOW MAXIMUM CAPACITY
2 PERSONS OR 350 LBS.

BOW MAXIMUM CAPACITY
3 PERSONS OR 500 LBS.

BOW MAXIMUM CAPACITY
4 PERSONS OR 600 LBS.

9

WARNING

The use of E-15 fuel in this vessel is prohibited by law. See Owners Manual for complete explanation.

10

Warning Label Locations

Refer to the diagrams below for the location of each label.

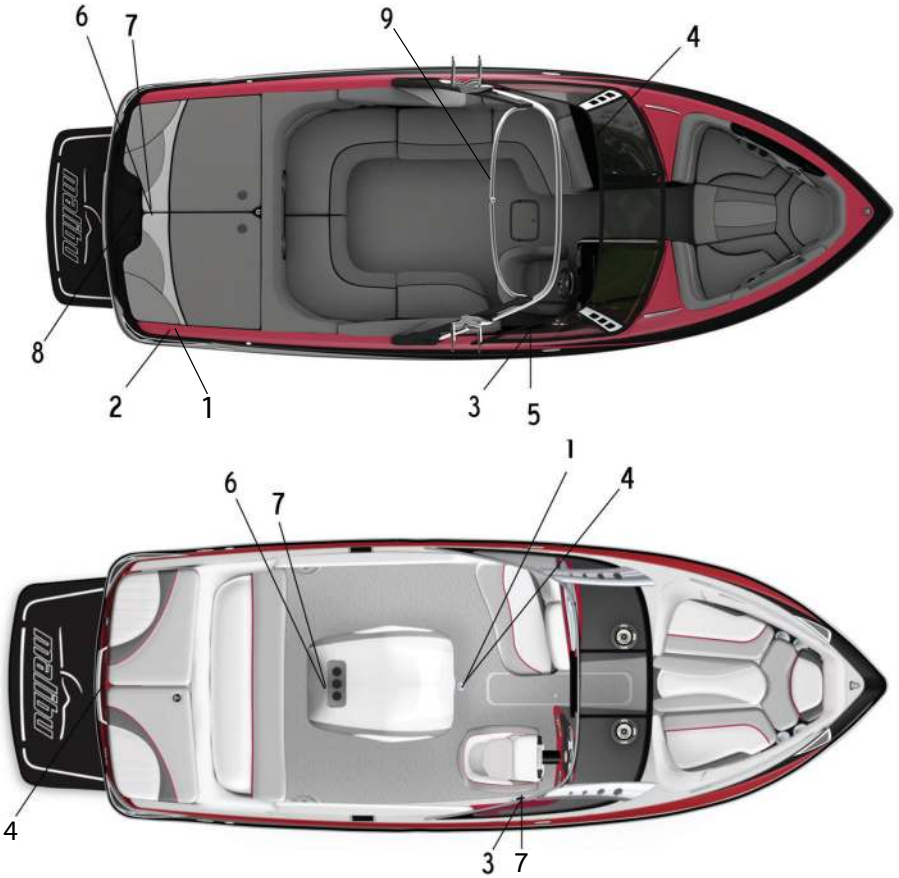

Basic Rules of the Road

Boating Regulations

The U.S. Coast Guard (USCG) is the governing authority of the United States waterways and serves to help the boating public. State boating regulations are enforced by local authorities. Owners and users outside of the United States must be cognizant of that country's laws and regulations. You are subject to marine traffic laws and "Rules of the Road" for both federal and state waterways; you must stop if signaled to do so by enforcement officers, and permit them to board if asked.

Review and understand all local, state, federal, and country boating laws.

There are many USCG pamphlets available to you. These pamphlets go beyond the contents of this manual and explain "Rules of the Road," signal lights, buoys, safety, international and inland regulations. An example is the Ultimate Watersports Handbook you should have received with your new boat, or which can be ordered by contacting WSIA; go to: www.WSIA.net. For more information, contact your local USCG unit or visit <http://www.uscgboating.org>.

You should be aware of these rules and follow them whenever you encounter another vessel on the water. The rules presented in this manual outline only the most basic of the nautical "Rules of the Road" and have been provided as a convenience only. Consult your local U.S. Coast Guard Auxiliary (USCGA), Department of Motor Vehicles (DMV) or local maritime authority for a complete set of rules governing the waters in which you will be using your boat. If you plan to travel—even for a short trip—you would be well served to contact the regional USCGA or DMV in the area where you will be boating.

The nautical Rules of the Road must be followed to prevent collisions between vessels. Like traffic laws for automobiles, the operator is legally required to follow the rules.

WARNING | *Collisions between boats can cause death or serious injury.*



Keep a proper lookout, safe speed, and follow the nautical "Rules of the Road."

Encountering Another Vessel

Any time two vessels on the water meet one another, one vessel has the right-of-way. It is called the "stand-on" or "privileged vessel". The vessel which does NOT have the right-of-way is called the "give-way" or "burdened vessel". These rules determine which vessel has the right-of-way, and accordingly, what each vessel should do.

Privileged Vessel

The privileged vessel has the right-of-way and has the duty to continue its course and speed, except to avoid an immediate collision. When you maintain your direction and speed, the other vessel will be able to determine how best to avoid you.

Conversely, the following illustration depicts a situation in which you are the boat in the center and you are the burdened vessel. You must give right-of-way to all vessels coming towards you from the directions shown in green.

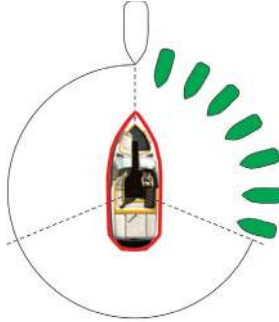

You are the burdened vessel.
You must give way.

Meeting Head-On

When meeting head-on, neither vessel has the right of way. Both boats should decrease speed, turn towards their right (starboard side) and pass on their left sides (port-to-port). However, if both boats are clearly on each other's right (starboard) side then, each vessel should sound two short blasts and pass on their right sides (starboard-to-starboard).



Passing
Port-to-Port



Meeting
Head-to-Head



Passing
Starboard-to-Starboard

Overtaking

The boat that is overtaking one ahead of it is the burdened boat and must make any adjustments necessary to keep out of the way of the privileged boat, until the burdened boat is well ahead and clear of the vessel being overtaken.

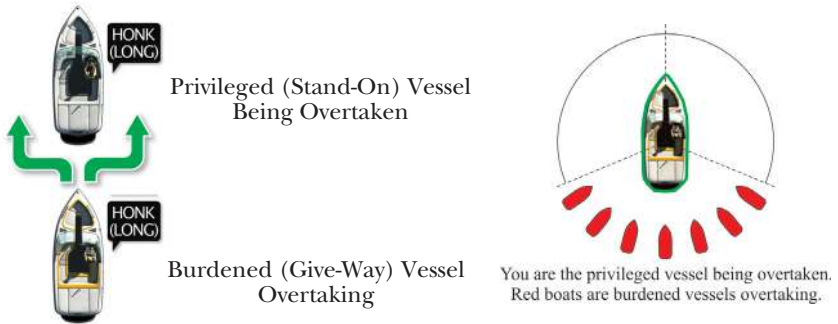

The General Prudential Rule

The General Prudential Rule regarding right of way, is that if a collision appears unavoidable, neither boat has right of way. As prescribed in the “Rules of the Road”, both boats must act to avoid collision.

Rule 2 in the International Rules says, “In construing and complying with these Rules due regard shall be had to all dangers of navigation and collision and to any special circumstances, including the limitations of the vessels involved, which may make a departure from these Rules necessary to avoid immediate danger.”

Other Rules of the Road

When navigating in narrow channels, you should keep to the right when it is safe and practical to do so. If the operator of a power-driven vessel is preparing to go around a bend that may obstruct the view of other water vessels, the operator should sound a prolonged blast on the whistle or horn—four to six seconds.

If another vessel is around the bend, it too should sound the whistle or horn. Even if no reply is heard, however, the vessel should still proceed around the bend with caution.

If you navigate these type of waters, you should carry a portable air horn, which are available from local marine supply stores.

Aids to Navigation

Learn to recognize the different buoys and day markers; they are the signposts of the waterways. The United States Aids to Navigation System (USATONS) is the primary marking system used on inland water, coastal waters and rivers in the United States. This system is maintained by the U.S. Coast Guard (USCG).

There are two primary marking systems in use in the U.S.: the Uniform State Waterway Marking System (USWMS), used on inland waters and maintained by each state, and the Federal Waterway Marking System (FWMS), used on coastal waters and rivers and maintained by the USCG. In addition, the FWMS has two modified systems: the Western River Buoyage, and the Intercoastal Waterway Buoyage. Be sure to check with local authorities on the buoyage system in use in your boating region.

The type of hazard/warning buoys and markers depends on the area of jurisdiction. Check with local boating authorities.

USWMS System

In the USWMS Lateral System, well-defined channels are marked with red and black buoys, and the boat should pass between them.

The USWMS Cardinal System is used when there is no well-defined channel or where an obstruction may be approached from more than one direction. With the cardinal system:

- Pass north or east of BLACK-TOPPED WHITE buoy.
- Pass south or west of RED-TOPPED WHITE buoy.
- RED and WHITE VERTICALLY STRIPED buoy indicates boat should pass outside of the buoy (away from shore).

FWMS System

The FWMS Lateral System is for use on navigable waters except Western Rivers and Intercoastal Waterways. The markings on these buoys are oriented from the perspective of being entered from seaward (the boater is going toward the port). This means that red buoys are passed on the starboard (right) side of the vessel when proceeding from open water into port, and green buoys to the port (left) side.

The right side (starboard) of the channel is marked with RED, even numbered buoys. The left (port) side of the channel is marked with GREEN, odd numbered buoys.

The middle of the channel is marked with RED and WHITE vertically striped buoys; pass close to these buoys.



Spherical Safe Water Marker

Obstructions, channel junctions, etc. are marked with RED and GREEN horizontally striped buoys.

A RED band at the top means the preferred channel is to the left of the buoy; a GREEN top band means the preferred channel is to the right of the buoy.

Day markers are colored and numbered the same as buoys. RED, triangular day markers with even numbers mark the starboard side of the channel. GREEN, square day markers with odd numbers mark the port side of the channel.

Lights, bells and horns are used on buoys for night or poor visibility conditions. Buoys with unique light flashing characteristics are identified on nautical charts with the specific flashing pattern.

Types of Buoys

There are several types and shapes of buoys. Buoys may be unlighted, lighted, with sound or may have both an audible and a visual signal. Lights, bells and horns are used on buoys for night or poor visibility conditions. Different shapes of buoys are shown below.



Unlighted Bell Buoy



Spar Buoy



Nun Buoy



Lighted Buoy



Can Buoy

FWMS Marking

System

Buoys with unique light flashing characteristics are identified on nautical charts with the specific flashing pattern.

Mooring Buoys

The only buoys from which you are permitted to moor are mooring buoys. Mooring buoys are white with a blue horizontal stripe. Mooring to a navigation buoy, regulatory markers or lateral markers is illegal.



**Mooring Buoy – White with Blue Band
May Show White Reflector or Light**

Uniform State Regulatory Markers

Regulatory markers indicate dangerous or restricted controlled areas. These markers are used to indicate speed zones, areas set aside for particular use, general information and directions.

Regulatory markers are white with orange geometric shapes and also have orange bands near the top and at the water line of the buoy. You must obey regulatory markers.

CONTROLLED AREA



DANGER



BOATS KEEP OUT



INFORMATION



Uniform State Waterway Marking System (USWMS)



Divers Flag



Alpha Flag



Distress Flag

USED BY RECREATIONAL DIVERS – INDICATES POSITION.

Stay Far Away From Diver Flags
Someone is underwater in the vicinity

WORLDWIDE VESSELS ENGAGED IN DIVING OPERATIONS – DOES NOT INDICATE DIVER'S POSITION

Stay Far Away From Diver Flags
Someone is underwater in the vicinity

INDICATES FELLOW BOATER IS IN NEED OF ASSISTANCE

Warning Markers

It is a good idea to ask local authorities if there are hazardous areas and how they are marked. Boaters must also recognize the flag designs, which indicate that skin divers are present and keep well clear of the area. Divers underwater cannot be seen. Stay well away from boats or floats displaying Diver Flags.



Skin Diver Warning Flag

Watch for swimmers. Swimming areas may not be marked. Steer clear from the area and remain alert.



Swim Area Warning Buoy

Navigation markers serve as a means of identifying navigable routes, and indicate water hazards. Boaters should become familiar with navigation markers and stay within marked boundaries and clear of hazards.

Night Running

Boats operating between sunset and sunrise (hours vary by state) must use navigational lights. Nighttime operation, especially during bad weather or fog can be dangerous. All “Rules of the Road” apply at night, but it is best to slow down and stay clear of all boats, regardless of who has right of way. Protect your night vision by avoiding bright lights and have a passenger, if possible, help keep watch for other boats, water hazards and aids to navigation. It is best to proceed slowly at night, as there is always the possibility of unlit boats, floating objects, and fixed objects which will be very difficult to see in time to avoid if you are at planing speeds or above.

There are many light patterns on different types of boats and for boats performing various functions while underway or at anchor. For most applications on recreational boats the following navigation light patterns are applicable.

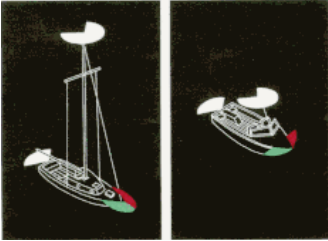

Figure 1

Motorboats less than 20 meters (65.62 feet) shall exhibit navigation lights as shown in **Figure 1**.

(Note: Two masthead lights are optional for boats under 50 meters. Boats over 50 meters (164 feet) will display two masthead lights.)

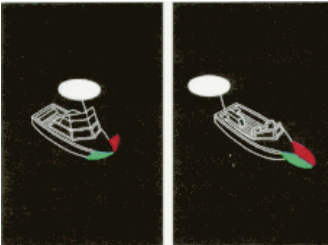

Figure 2

Motorboats of less than 12 meters (39 feet 4 inches) in length, may show the lights in either **Figure 1** or **Figure 2**.

Boats of less than 7 meters (23 feet) whose maximum speed cannot exceed 7 knots may exhibit an all-around white light, and if practicable sidelights instead of the lights prescribed above, **in international waters only**.

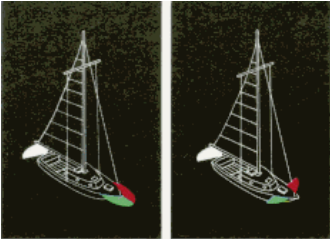

Figure 3

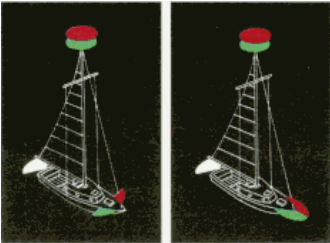

Figure 4



Figure 5

Sailboats and Watercraft Under Oars

Sailboats less than 20 meters (65.62 feet) may exhibit the navigation lights shown in **Figures 3** or **4**.

Another option for sailboats is to use a single combination lantern at the top of the mast as shown in **Figure 5**.

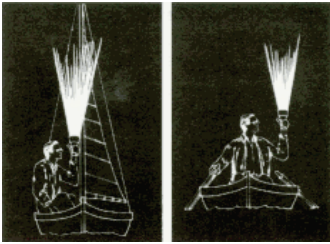

Figure 6

Sailboats less than 7 meters (22.96 feet) may carry an electric torch or lighted lantern showing a white light to be displayed in sufficient time to prevent collision (see **Figure 6** - left picture).

If practicable, the lights prescribed for sailboats less than 20 meters should be displayed.

Watercraft under oars (such as a canoe) may display the lights prescribed for sailboats, but if not, must have ready at hand an electric torch or lighted lantern (flashlight) showing a white light to be displayed in sufficient time to prevent collision (see **Figure 6** - right picture).

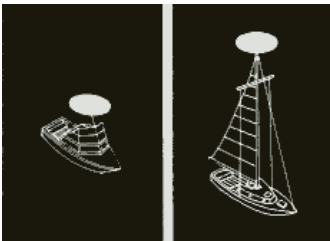

Figure 7

Anchored Boats

Motorboats and sailboats at anchor must display anchor lights. An anchor light for a watercraft less than 50 meters (164 feet) in length is an all-around white light, visible for 2 miles exhibited where it can best be seen (see **Figure 7**).

Sailboats operating under machinery, or under sail and machinery, are considered power driven and must display the lights prescribed for a power-driven boat.

Watersports Safety

Skiers or riders are obligated to be aware of the same fundamental safety rules as boat operators. If you are new to water skiing, wakeboarding, wake surfing, and other towed watersports, seek certified training before starting. You will find it especially helpful to join a local ski club, World Wakeboard Association, and/or the USA Water Ski, when possible.

Always remember that the majority of injuries occurring while water skiing/wakeboarding and other towed watersports are the result of impacts with other objects. Always look where you are going and be aware of what is going on around you. When participating in towing watersports, be safe and courteous and follow these guidelines:

- Be considerate to fishermen and others who are sharing the same body of water.
- DO NOT perform watersports in congested areas.
- Stay away from navigation markers.
- Stay away from other boats and watersports participants.

DANGER



Contact with a spinning propeller can cause injury and death.

Do not enter or exit the water when the engine is running (ON) and the propeller is spinning.

Do not get on the swim platform when the engine is running.

Do not swim towards the back of the boat if the engine is on.

WARNING

Failure to adhere to these warnings may result in severe injury or death to you and/or others.

- ***Every towed person must always wear a USCG-approved personal flotation device.***
- ***Always have an experienced driver and a designated observer in the boat while being towed.***
- ***Maintain a distance of at least 100 feet from all other objects, including other boats, piers, rafts, mooring and navigational buoys, pilings, abutments, or any other items.***
- ***Never waterski, wakeboard or participate in other towed watersports in shallow water, close to shore, or in water where you do not know the depth or what is beneath the surface.***
- ***Never put your arm, head, or any other part of your body through the handle-bridle of the tow line nor wrap the line around any part of the body at any time.***
- ***Do not participate in watersports while under the influence of alcohol and/or drugs.***
- ***Do not participate in watersports during inclement weather or on rough water.***
- ***Never waterski, wakeboard or participate in other towed watersports directly in front of other boats who may run over you if you fall.***
- ***Never waterski, wakeboard or participate in other towed watersports at night.***
- ***Never jump from a boat that is moving at any speed.***
- ***Make sure that everyone knows and uses approved towed watersports hand signals.***

Hand Signals

Make sure that everyone knows and uses approved towed watersports hand signals, shown below.



Circle



Back to Dock



Cut Engine



Skier in Water



Skiers OK



Speed OK



STOP



Speed Faster



Speed Slower



Turn Left



Turn Right

Towed Person Safety Responsibilities

Most injuries and fatalities that occur on high-performance recreational tow boats occur to the persons being towed (water skiing, kneeboarding, wakeboarding, wake surfing, tubing, etc.). It is the responsibility of the boat operator to pay attention to a multitude of things while utilizing the boat for water tow sports. The towed person has little or no control over their path nor do they have much in the way of protection from impact with obstacles or other boats. Therefore, it is recommended that boat operators, observers, and towed persons communicate effectively and clearly as to their intentions and their surroundings. The main responsibilities for each participant are as follows:

Operators should:

- Assign a passenger to be a designated observer.
- Turn the engine off whenever a person is on the swim platform or in the water near the boat. This is especially important for the area near the back of the boat to avoid propeller injuries.

- Ensure that it is “all clear” behind the boat when starting the engine. Ask for verbal confirmation or hand signals that it is “all clear” behind the boat. Then, and only then, start the engine.
- Keep their main focus on maneuvering the boat safely while avoiding other boats, fixed objects, the shore, and shallow water.
- Use rear view mirrors to allow the driver to glance at the towed person, while still keeping their main attention on the path of the boat and the surroundings.
- Return safely to pick up towed persons or persons in the water. Keep the individual in view, approach slowly (preferably on the driver’s side), and shut off the engine when close to an individual in the water. Do not back up or operate the boat in reverse to a person in the water.

Observers should:

- Confirm for the boat operator that it is “all clear” behind the boat prior to starting the engine.
- Watch the towed person.
- Be responsible for communication of the signals and status of the towed person to the boat driver.
- Notify the boat operator of status and changing conditions with the towed person, and inform the boat driver of the towed person’s readiness to start, their desire to go faster or slower, or that they have fallen and are in need of retrieval.
- Deploy the fallen skier flag when the towed person falls, if needed. In some states, it is required to raise the “fallen skier” flag when the skier has fallen.
- Monitor the tow line to ensure that it does not become tangled, it does not become wrapped around anyone in the boat, and it does not become wrapped around the towed person. Also monitor the tow line so that it does not become tangled in the propeller. Notify the boat operator if any of these conditions are observed to avoid potential injury.
- Remind the boat operator to shut off the engine when persons are on the swim platform or in the water near the back of the boat.

Towed persons should:

- Wear a PFD.
- Not approach the back of the boat if the engine is running.
- Not become entangled in a tow line or wrap a tow line around any body part.
- Know signals to communicate with the observer and boat operator.

Additional Precautions for Towed Skier/Rider

- Wear wet suits or protective shorts when engaging in high energy skiing/riding to prevent abrasions, hypothermia, and injuries to orifices (rectal and vaginal) from impact with the water surface.
 - Inspect watersports equipment for wear, fraying, etc., before use. DO NOT use if they show signs of wear or fraying. Ropes or watersport equipment tow points may break during use, causing you to coast into obstacles or fall with the risk of being struck by another vessel.
 - Inspect the boat tow points before use. If there is any evidence of corrosion or other damage, do not use until it has been inspected by your authorized boat dealer.
-

- NEVER attach ski/wakeboard rope to anything but approved pylons and wakeboard towers. Make sure tow ropes are properly attached to the boat tow points.
- The skier/rider should verbally indicate that s/he is safely clear of the boat prior to operator starting the boat engine or putting the boat into gear.
- Slowly take up slack in tow lines before accelerating to watersports speeds. Jerking the slack out of a tow line can cause high forces on the rope and towing equipment. This may cause the rope or equipment to break and the rope to snap back at occupants of your boat and at the towed person.
- Never put your arm, head or any other part of your body through the handle/bridle of the ski or wakeboarding line, nor wrap the line around any part of the body at any time. If you fall, the line will tighten and forcefully constrict around your body part and may result in amputation.
- DO NOT ski near swimming areas, beaches, personal watercraft, or other vessels/boats.
- Never attempt land or dock starts. These activities will increase your risk of injury or death.
- DO NOT jump from a boat that is moving at any speed, nor enter or exit the water when the engine is running.
- DO NOT “back up” to anyone in the water; they will be in danger of hitting the spinning propeller which can cause severe injury or death.
- DO NOT follow directly behind another boat or skier/rider without leaving an adequate safe distance in case that towed person falls into the water. You will need ample time and distance to maneuver your boat away from that person in the water and to avoid their tow boat which will be circling back to retrieve their downed person.
- DO NOT participate in towed watersports at night. It is illegal and other boats will not be able to see you, nor will they anticipate or expect your presence behind the towing boat. Furthermore, once you fall they will not see you swimming.
- DO NOT tow with multiple skier/riders with different length ropes.
- DO NOT ski in limited visibility conditions.
- Never climb, sit or stand on a wakeboard tower. The wakeboard tower is intended for towing only as noted. It is designed to pull a limited number of individual(s), and in some cases only one (1) individual. Please consult the remainder of this manual and warning labels on tower for details. The wakeboard tower approved for use on your boat should be used only for water skis, wakeboards or recreational towables, and not for parasailing, kite flying or towing other boats.
- Many states require the use of “skier down” flags. Check your local lake and state requirements. Having the observer raise a skier down flag when your towed watersport participant falls down or off the towed device will alert boats around you to the fact that someone is in the water nearby and that they should avoid the area.
- Many lakes have recommended tow patterns. Other boats may expect that you know the local customs and practices. It is common that the tow pattern is counter-clockwise around the lake, but there are exceptions. Check for local recommendations or requirements.
- NEVER lift or trailer the boat with water in the bilge or in ballast tanks. Lift or trailer per manufacturer’s instructions.
- Around marina docks where electrical current is present (such as shore power connections) it is unsafe to swim as stray electrical currents may exist which can cause you to drown.

Tow Line Guidelines

Tow lines come in different lengths and strengths for different activities. Make sure any line you are using is suited for skiing or riding and that it is in good condition.

- Never use a tow line that is frayed, knotted, unraveling or discolored from use or being left in the sun. If a line breaks while in use it can recoil at the skier/rider being towed or into the watercraft where it might strike passengers. Replace tow lines with any sign of damage.
- Never use a tow line with elastic or bungee material to pull skiers or riders.
- Tow line should be attached to the watercraft in an approved fashion with hardware designed for towing. Refer to your watercraft manual for instructions on proper tow line attachment.
- Always route tow lines away from the propeller, even when idling. Shut off the engine if your boat starts to cross a floating tow line.
- If a tow line should become entangled in a propeller, shut off engine, remove the key and put it in your pocket before retrieving the line.
- Tow lines should be neatly coiled and stowed in the boat when not in use.

Fallen Skier or Rider

Falling and injuries are common in water skiing and other towed watersports. Keep tow speeds in a comfortable range given the rules of the activity and the skill level of participants.

- Display a red or orange skier/rider down flag to alert other vessels that a skier/rider is down. In some states, it is required to raise the “fallen skier” flag when the skier has fallen.
 - Turn the boat and slowly circle toward the person in the water to return the tow line handle or towed device to that person.
 - Always keep the fallen skier/rider in view and preferably on the operator’s side of the watercraft.
 - Put the watercraft in neutral whenever you are near a fallen skier/rider.
 - Shut off the engine when retrieving someone from the water or if the person in the water gets too close to the boat. Do not trust neutral gear with an idling engine. Someone may accidentally or prematurely shift the gear, or the linkages may be out of adjustment and the propeller may still be slowly spinning.
-

Develop WATER SENSE

The Watersports Responsibility Code and the Watersports Safety Code have been developed by WSIA and industry equipment manufacturers. These Codes are reproduced here for your reference.

Watersports Responsibility Code



Familiarize yourself with and follow The Watersports Responsibility Code

WATERSPORTS RESPONSIBILITY CODE

Be aware that there are risks in boating and Watersports that good judgment and personal awareness can help reduce.
To increase your enjoyment of Watersports, follow the ten elements of the Code.

In Watersports it is your responsibility to:

- **ALWAYS** familiarize yourself with applicable laws, waterways and inherent risks
- **ALWAYS** have a capable observer in addition to driver and agree on hand signals
- **ALWAYS** wear a USCG type III, ISO or other agency approved (PFD) life jacket
- **ALWAYS** read user's manual and inspect equipment before use
- **ALWAYS** ski or ride under control, at proper speeds and within your limits
- **ALWAYS** turn ignition off when anyone is near watercraft power drive unit
- **ALWAYS** stay clear of engine exhaust to avoid Carbon Monoxide poisoning
- **NEVER** "Platform Drag" or touch swim platform while the engine is running
- **NEVER** ski or ride near swimmers, shallow water, other boats, or obstacles
- **NEVER** operate watercraft, ski or ride under the influence of alcohol or drugs

Watersports Safety Code

WATERSPORTS SAFETY CODE

Before you get in the water: Skiing or riding instruction is recommended before use. Instruction will teach general safety guidelines and proper skiing or riding techniques, which may reduce your risk of injury. For more information on skiing or riding schools, contact your dealer, Association, or local ski club.

- Know the federal, state and local laws that apply to your area.
- If you are not familiar with a waterway, ask someone who is knowledgeable to tell you about any hidden dangers or things to avoid.
- Whether you plan to be in a watercraft, or skiing/riding behind one it is important you are wearing a properly fitted life jacket (PFD) approved by your country's agency, USCG Type III, ISO, etc.
- Inspect all equipment prior to each use, check bindings, fins, tube, attachment, tow rope and flotation device. Do not use if damaged.

Watercraft Safety: A knowledgeable and responsible driver is the most important safety device on any watercraft.

- Never operate a watercraft, ski or ride under the influence of alcohol or drugs.
- Only use water ballast and people for additional weight.
- Never exceed the passenger or weight limitations of the watercraft.
- Never allow passengers to hang outside the watercraft or towed device or sit on the gunwales or anywhere outside of the normal seating area.
- Never allow water to overflow the bow or gunwales of the watercraft.
- Uneven weight distribution or additional weight may affect the handling of the watercraft.

Carbon Monoxide: The exhaust from the engine on a watercraft contains Carbon Monoxide (CO) which is a colorless, odorless and poisonous gas. Excessive exposure to CO can cause severe injury or death. Follow this advice to avoid injury.

- Never "Platform Drag" by holding onto the boarding platform or being dragged directly behind the watercraft. This is where CO will be.
 - Do not sit on the watercraft transom or boarding platform while the engine is running.
 - Make sure the engine is properly tuned and running well. An improperly tuned engine produces excessive exhaust and CO.
 - If you smell engine exhaust do not stay in that position.
 - Go to the United States Coast Guard's website: (www.uscgboating.org) for more information on how to help protect yourself and others from the dangers of CO.
-

Tow Ropes: Tow ropes come in different lengths and strengths for different activities. Make sure any rope you are using is suited for that activity and that it is in good condition.

- Never use a rope that is frayed, knotted, unraveling or discolored from use or being left in the sun. If a rope breaks while in use it can recoil at the skier/rider being towed or into the watercraft where it might strike passengers. Replace tow ropes with any sign of damage.
- Never use a tow rope with elastic or bungee material to pull skiers or riders.
- Rope should be attached to the watercraft in an approved fashion with hardware designed for towing. Refer to your watercraft manual for instructions on proper tow rope attachment.
- Always keep people and tow ropes away from the propeller, even when idling.
- If a tow rope should become entangled in a propeller, shut off engine, remove the key and secure it in a safe location before retrieving the rope.
- Tow ropes should be neatly stowed in the boat when not in use.

Preparing to ski or ride: Always have a person other than the driver act as an observer to look out for the skier/rider.

- Be sure the driver is aware of the experience and ability of the skier/rider.
- The driver, observer and skier/ rider need to agree on hand signals before skiing or riding. Signals should include READY, STOP, SPEED UP, and SLOW DOWN.
- Start the engine only after making sure that no one in the water is near the propeller.
- Turn the engine off when people are getting into or out of the watercraft, or in the water near the watercraft.
- Always make sure the tow rope is not wrapped around anyone's hands, arms, legs, or other parts of the body.
- Start the watercraft and move slowly to remove slack until the tow rope is tight.
- When the skier/rider signals READY and there is no traffic ahead, take off in a straight line. Adjust the speed according to the signals given by the skier/rider.

Skiing or Riding: The watercraft and skier/rider should always maintain a sufficient distance from obstacles so a skier/rider falling or coasting and/or watercraft will not encounter any obstacle.

- Do not use in shallow water or near shore, docks, pilings, swimmers, other watercraft, or any other obstacles.
- Use only on water.
- Never attempt land or dock starts. This will increase your risk of injury or death.
- Always wear a properly fitted life jacket (PFD) approved by your country's agency, USCG Type III, ISO, etc.
- The faster you ski or ride, the greater your risk of injury.
- Never make sharp turns that may cause a slingshot effect on the skier/rider's speed.
- The Skier/Rider should be towed at an appropriate speed for his or her ability level.

Fallen skier or rider: Falling and injuries are common in skiing or riding.

- Circle a fallen skier/rider slowly to return the tow rope handle or pick up the fallen skier/rider.
- Turn off the engine when near a fallen skier/rider.
- Always keep the fallen skier/rider in view and on the driver's side of the watercraft.
- Display a red or orange skier-down flag to alert other vessels that a skier/rider is down if required by the state in which you are operating.

The Warnings and practices in the Watersports Safety Code represent common risks encountered by users. The code does not cover all instances of risk or danger. Please use common sense and good judgment.

Emergency Procedures

In an emergency situation, you may have to resort to measures which are not commonly practiced. Always assess the dangers of being in harm's way versus the protection of equipment. Keep a sound mind during an emergency and always use common sense.

Explosion and Fire

Many boat fires and explosions involve flammable liquids such as gas or oil, which are used in your boat's propulsion engine(s) and generator. **Carefully follow all warning labels and safety precautions while handling flammable substances.** Many fires in inboard boats start in the bilge area due to gasoline vapors. Gasoline vapors are heavier than air and collect in the bilge of boats.

Explosion

- If explosion is imminent, put on PFDs, grab distress signals and survival gear, and immediately abandon ship.

Fire

- Immediately turn off engines, generators, stoves and blowers.
- Extinguish smoking materials.
- A fixed fire suppression system, if equipped, has heat sensors that automatically flood the machinery space with a fire extinguishant. Allow extinguishant to "soak" the compartment for at least 15 minutes to cool the hot metals or fuel before cautiously inspecting the fire area. Have portable fire extinguishers ready. Do not breathe fumes or vapors caused by the fire or extinguishant.
- If no fixed fire suppression system is installed and a fire is in the engine compartment, discharge portable fire extinguishers through the engine compartment access plate, if equipped. DO NOT open the engine hatch as this feeds oxygen to the fire.
- If you have access to the fire, direct the contents of the fire extinguishers at the base of flames, not at the top.
- Throw burning materials overboard if possible.
- Move anyone not needed for firefighting operations away from the flames.
- Signal for help.
- Put on PFDs (Personal Flotation Devices), grab distress signals and survival gear, and prepare to abandon ship.

WARNING



Burn hazard from gasoline floating on water which is ignited can cause death or serious injury.

Gasoline will float on top of water and can burn. If the boat is abandoned, swim upwind, far enough to avoid fuel that can spread over the surface of the water.

Swamping and Flooding

In the event that the vessel begins to take on water, turn on the bilge pump to evacuate water and slow its accumulation, and try to determine the source of the water. A collision with an underwater object can cause the hull to develop a leak. A loose fitting hose clamp on a piece of equipment can cause a leak. Try to repair the leak if possible. If a leak is threatening the safety of you and your passengers, call or signal for assistance.

- Turn on bilge pump(s).
- Access PFDs, pass them out to everyone, and put them on.
- Identify source of leak and try to stop the leak and flooding.
- **STAY WITH THE BOAT!** A boat will usually float even if there is major hull damage. Rescuers can spot a boat much easier than a head bobbing in the water.
- Signal or call for help.
- If others were on board, try to locate them, make sure that they are conscious and that they can swim.
- Immersion in water speeds the loss of body heat and can lead to hypothermia (the abnormal lowering of internal body temperature).

Capsizing

- If others were on board, try to locate them, make sure that they are conscious and they can swim.
- If possible, access lifejackets (PFDs), pass them out to everyone, and put them on.
- **STAY WITH THE BOAT!** A boat will usually float even if there is major hull damage. Rescuers can spot a boat much easier than a head bobbing in the water.
- Signal or call for help.
- Immersion in water speeds the loss of body heat and can lead to hypothermia (the abnormal lowering of internal body temperature).

Staying Afloat

- Remain calm. Do not thrash about or try to remove clothing or footwear. This leads to exhaustion and increases the loss of air that may keep you afloat.
- Keep your lifejacket (PFD) on.
- Keep your knees bent.
- Float on your back and paddle slowly to safety.

Collisions

- Immediately account for all passengers.
 - Check for injuries.
 - If any person is in the water make sure they have proper flotation devices.
 - Assess the hull for damage.
 - Activate the bilge pump(s) to reduce any flooding.
 - Try to operate the boat to keep the damaged area above water.
 - If necessary, call or signal for assistance.
 - **STAY WITH THE BOAT!**
-

Grounding

In the event you run aground, assess the situation before proceeding. Your response to grounding will depend on how hard the boat hits bottom and whether the boat remains stranded, the extent of damage, and proximity to shore and help.

- If it is a simple touch, you may need only to inspect the hull.
- If you are aground, assess the situation before reacting. In some cases, throwing the boat into reverse can cause more damage.
- Check for leaks and immediately stop any water from entering the boat.
- Inspect the hull, steering system and propulsion system for damage.
- Maneuver the boat to safe water only if the hull and all operating systems are in satisfactory operating condition. Otherwise, call or signal for assistance.

Person Overboard

- Immediately react to a person who has fallen overboard by sounding an alarm.
- Keep the victim constantly in your sight.
- If another passenger is on board, assign them to look at and keep pointing at the person in the water. They are to do nothing else but stay focused on the person in the water and to point at them.
- Throw the person a life preserver even if they are wearing a PFD. It will serve as a marker in the water and will provide additional flotation.
- Immediately slow or stop the boat and safely circle toward the victim as soon as possible.
- Keep the victim on the helm side of the vessel so as to keep the victim constantly in your sight.
- When almost alongside, shut off the engine.
- Assist the person into the boat.

Drowning

- Swim to rescue a drowning victim only as a last resort.
- Immediate resuscitation is critical! It may be possible to revive a drowning victim who has been under water for some time and shows no sign of life. Start CPR immediately and get the victim to a hospital as quickly as possible.
- Keep the victim warm.
- Use care in handling. Spinal injury may exist if the victim fell overboard.
- Call and signal for help.

Medical Emergency

In an emergency, you may be far from professional medical assistance. Be prepared and know how to use your first aid kit. Be aware of any special medical conditions of your passengers.

Operation Failure

If you experience a propulsion, electrical, steering or control failure, immediately shut off the engine. If it is safe to do so and you are qualified, then try to determine the cause of the failure and repair. Otherwise, call or signal for assistance. Anchor the boat if drifting will put you and others in danger.

Towing

WARNING



Towing or being towed stresses the boats, hardware and lines. Failure of any part can seriously injure people or damage the boat.

A recreational boat towing another should be a last resort due to the potential for damaging one or both boats. The Coast Guard or a private salvage company is better equipped for this activity. A recreational boat may assist by standing by, and possibly by keeping the disabled boat's bow at a proper angle until help arrives. Only when conditions are ideal—that is, waters are calm, disabled boat is small, appropriate hardware is available, and one or both skippers know the correct technique—should a recreational boat tow another.

Towing Vessel

- Be sure your boat will not run aground too.
 - Because you are maneuverable and the grounded boat is not, you should pass the towline to the grounded boat.
 - Select an appropriately strong tow line. Use double-braided or braid-on-braid line. Never use three-strand twisted nylon; it has too much elasticity and can snap back dangerously.
 - Select an appropriate attachment point. If available fasten the towline to the forward tow pylon of the towing boat. Otherwise fasten tow line to stern tow point. Fastening to the stern tow point will restrict maneuverability of the towing boat.
 - If possible, use a bridle.
 - Move slowly to prevent sudden strain on slack line.
 - Proceed at slow speed.
 - Avoid abrupt changes in throttle as that may cause the tow line to slacken and jerk tight. Sudden strain or jerking the line causes excessive tow line forces which may part the line. Keep slack out of the tow line, but if it occurs proceed slowly to again take up the strain on the line and avoid sudden jerks in the line.
 - Be ready to cast loose or cut the line if the towing situation becomes hazardous.
-

Vessel Being Towed

- Attach the towline to the bow eye.
- If it is necessary to be towed after being freed, keep someone at the wheel to steer.

Both Vessels

- If you attach the towline to a fitting, be sure the fitting is fastened with a through bolt and is reinforced on the underside.
- Keep lines clear of propellers on both boats.
- Keep hands and feet clear of the other boat. Do not get caught, or pinched between the two boats as severe injury could occur.
- Never hold a towline after it is pulled taut.

Chapter 2

GAUGES & CONTROLS



No other ski boat manufacturer incorporates in their product as many innovative and technically advanced features as Malibu.

Standard Gauges

The following gauges are included on all models. It is important for the safe and proper operation of your boat to fully understand these gauges.

Malibu In-Dash Graphical Display



Figure 2-1. Graphical Display (TXi, Response, Response LX)



Figure 2-2. MaliView Dash with Malibu Touch Control (All Wakesetters)



Figure 2-3. Dash Display (VTX20, TXi – optional)

Malibu's state-of-the-art Malibu Graphical In-Dash Display Center enables the operator to observe and control many graphic functions that are applicable to the performance and use of your boat. These include Malibu Cruise Control, Ballast Monitoring System (BMS), Air/Sea Temperature, Depth, as well as standard use gauges for monitoring service requirements, voltage, engine temperature, oil pressure, remaining fuel level and percentage, speedometer and tachometer.

MaliView Gauge Screens



- Press the “SAVE PRE-SET” button to edit the highlighted pre-set. (See MaliView Edit Pre-Sets Screen.)
- Change the cruise RPM or speed set-point using the “UP” and “DOWN” buttons.
- Turn cruise on or off by pressing the “ENTER” button.
- Press the “MUTE” button to mute the radio.

Analog Selection



Video Selection



Digital Selection



Tachometer

Located to the left side of the dash panel, the tachometer registers the operating speed of your engine in revolutions per minute (RPM). This gauge is used to provide you with information needed to ensure the engine is kept within the engine manufacturer's recommended proper range of operation. For your additional benefit, there are other RPM monitoring capabilities available in your dash system that will be explained later in this manual. Also included in the gauge panel are additional digital readings for oil, volt and hour meter. The system defaults to these readings from the display panel and no adjustments are possible. Be sure to consult your engine manual for the correct range of operation for your particular engine model.



Figure 2-4. Tachometer with Oil, Volt Hourmeter

NOTICE

Do not operate your boat beyond the recommended RPM range. This could cause irreversible problems, and may not be covered under your engine warranty.

Speedometer

The Speedometer registers speed in miles per hour (MPH). The speedometer system consists of a thru-hull paddle wheel speed sensor that records water movement which sends information to a computer located under the dash. The speedometer readings can also be found in the digital display window of the In-Dash graphical display located in the center of the gauge panel. Additional information will be explained later in this manual for this display. The speedometer is calibrated from the factory and does not normally require adjustment. However, from time to time it may be necessary to recalibrate. To calibrate the speedometer, see *Speedometer Calibration* in this manual. Also included in the speedometer gauge panel are additional digital readings for depth, air and lake temperatures. The system defaults to these readings from the display panel and no adjustments are possible.



Figure 2-5. Speedometer with Depth, Air and Lake Temperature Gauge



Figure 2-6. Dash Gauges

Engine Temperature

The temperature gauge is located at the lower center left bottom panel of the dash display. The temperature gauge indicates the temperature of the water/coolant inside the engine. The proper operating range for your engine is between 140 – 185° F. All engines are equipped with an engine control module that will cause the engine to run at reduced speeds (power reduction mode) if the engine is running above recommended operation temperatures. If you notice that your speed has reduced during normal running operation without reducing the throttle, monitor your temperature gauge. If your temperature gauge indicates excessive temperatures, slow down immediately and turn off engine. Continuing to operate the boat while the temperature is above normal operating parameters may cause serious damage to your engine.

Fuel

The fuel gauge is located at the lower center right bottom panel of the dash display. The fuel gauge indicates the approximate quantity of fuel remaining in the tank when the ignition is in the “On” position. Although your fuel tank will still have some fuel remaining even though the gauge reads empty, it is recommended that the tank be filled when the gauges indicates 1/4 full.

WARNING | *Do not top off tank.*



Note: It is not uncommon during operation of your boat for the fuel gauge to register slightly different amounts than what is actually in the tank. This is normal operation and does not indicate a problem. The fuel gauge will read most accurate when sitting still in calm water.

Oil Pressure

The oil pressure gauge is located at the lower center of the bottom panel of the dash display. The oil pressure gauge indicates the oil pressure in the engine while the engine is running and is measured in pounds per square inch (psi). Oil pressure may vary with engine speed, outside temperatures, oil viscosity and other environmental factors. If the oil pressure reading is below the normal range, you should stop your engine and check your oil immediately.

Average pressure ranges from 6 psi at 1000 RPM and 40 – 50 psi at cruising speeds. Oil pressure may be slightly higher on 5.7L engines at cruising speeds. If you are experiencing low oil pressure, stop your engine and check your oil before operating again.

WARNING



Do not continue to run engine if pressure is low. If you do the engine can become so hot that the surrounding components could catch fire.

NOTICE

Damage caused from neglected oil problems can be costly. Such damage is not covered by your warranty.

Malibu Graphical In-Dash Display

Note: For boats using the Viper II instrument system, refer to the Viper II owner's manual in the information packet shipped with your boat.

The following boats will include the Malibu Graphical In-Dash Display as a standard feature:

- Response
- Response LX
- Response TXi
- VTX20

This display can be found in the center of your dash console behind the steering wheel. Information is displayed in digital format for easy to read information, navigable using the Function up ↑ arrow, or Function down ↓ arrow followed by pressing the Enter (E) button in the center right of the display panel. The Graphical Display includes these features: Malibu Cruise, Ballast Monitoring System (BMS) “Available in wakeboard models only,” Air/Sea Temp, Depth meter, Power Wedge and service.



Figure 2-7. In-Dash Display



Figure 2-8. MaliView In-Dash Display

MaliView Setup Screen



- The up and down arrows toggle through all the options in each edit screen.
- Use the “ON/OFF/ENTER” button to toggle between edit screens and select changes.

Return to Factory Default Screen



- This will return all settings back to factory settings.
- Pre-sets will be reset.

MaliView USB Update Screen



Adjust Auto Volume

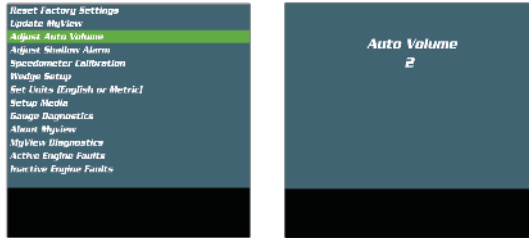

Automatically increases/decreases the volume of the stereo as boat speed increases/decreases

Depth Level Alarm Screen

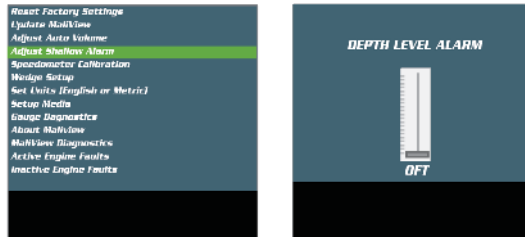

Speed Calibration Screen



Wedge Setup Screen



English Metric Mode (English or Metric Conversion)

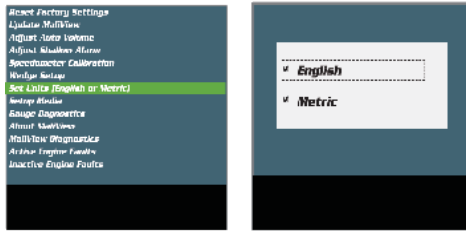

Video ON/OFF Setup



Turns on or off all available video screens

Gauge Diagnostic Mode (Gauge Sweep Mode Test)



Current Software Version



System Diagnostic Screen

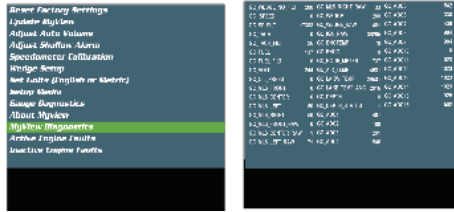

Active and Inactive Engine Fault Screen

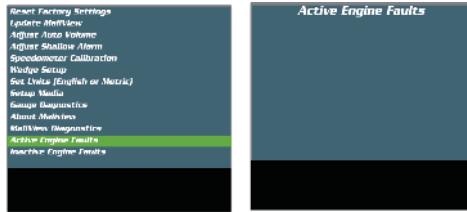

Malibu Surf Gate™

The SURF GATE control will appear on every touch screen except the SETUP screen once enabled. To enable the Surf Gate, access the SETUP screen in the SWITCH page. Use the up/down buttons to highlight the SETUP SURF GATE option to enable.



The SURF GATE must be enabled and calibrated in the viper setup screens. Press the SETUP button to access the SURF GATE ENABLE screen. Make sure the little box is checked. After enabling the SURF GATE you will need to calibrate the gates. This process is automatic once it's started. Just follow the instructions on the screen.

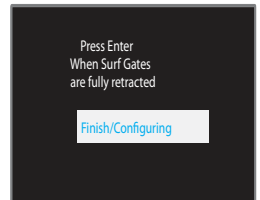
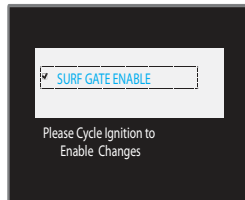
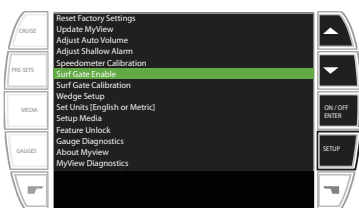

Button Modes



SURF GATE CENTER GREEN indicates that both gates are in the retracted position.

LEFT yellow indicates that the right gate will extend when the boat is above 7 mph and below 13.6 mph.

LEFT green indicates that the right gate has extended fully for surfing on the left side of the boat.

RIGHT yellow indicates that the left gate will extend when the boat is above 7 mph and below 13.6 mph.

RIGHT green indicates that the right gate has extended fully for surfing on the right side of the boat.

Alert banner that a left or right surf button has been pressed.

Caution banner for over speed with a Surf Gate out. The gate will automatically retract until speed has returned below 13.6 mph.

Error with Left RAM

Error with Left RAM

Error with Right RAM

Error with Right RAM

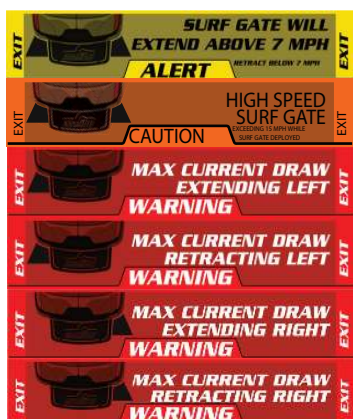

Surf Service

Surf Service will enable both gates to fully deploy. This feature can only be accessed while the boat is not moving.

The Surf Service feature is recommended to be used when the swim platform needs to be removed or added without the interference of Surf Gates.

Malibu Mobile Device Gateway

The MDG (Mobile Device Gateway) system is automatically added to the Touch screen when the MDG module is installed. If MDG is not automatically enabled then you can manually enable it on the Setup screen. The plug for the MDG and MDG harness is located by the radio black box under the glove box.



If the MDG is turned off or there is no device connected the button will appear grey.



If MDG has a device connected or turned on the button will appear white.



When setting up the MDG for a new boat, it's a good idea to rename the boat. This is done by pressing the NAME button and using the key pad to create the new name. This name will be listed when scanning with other Bluetooth devices.



Once the MDG is turned on by pressing the ON/OFF button the boat is discoverable by other devices. The system can control what device is connected by either accepting or declining the connection. Only one device at a time can be connected.



The HELP button will share additional information on how to use the MDG system.



What is This?

Mobile Device Gateway

The Medallion Mobile Device Gateway connects the boat's helm to a Mobile Device via Bluetooth®, allowing Helm® Phrases created with the free Medallion Perfect-Full® App to be uploaded to the helm, and music files to be streamed into the boat's audio system AUX input.

1) Download the Medallion Perfect-Full® App for Apple® or Android® Devices.

2) Visit www.perfect-full.com for More Info

1 of 3

EXIT HELP

How To Connect?

- TURN ON the Gateway
- ENTER a Boat Name
- TURN ON Mobile Device Bluetooth®
- ENTER Boat Name on Mobile Device
- VERIFY the Connection

2 of 3

EXIT HELP

How To Play?

- CHANGE the Source to AUX IN using the Radio Station Station. Should more than one AUX input option, select AUX1 first.
- OPEN the Audio Player on the Mobile Device
- CONTROL Audio With the Mobile Device

3 of 3

EXIT HELP

Malibu Pre-Sets

How to Use the Malibu Pre-Sets

The Malibu pre-sets Save, Store and Control 4 different parameters:

- 1 – Boat Speed/Cruise Control
- 2 – Wedge Angle/Boat Angle Control
- 3 – Ballast Level
- 4 – Surf Gate

The system is easy to operate once you understand what you are controlling and know what to expect from it. It will require that you read the instructions and spend a little time learning how to save and edit the pre-sets to get the full benefit of the system.

The factory pre-sets are the same settings for every boat. These were developed and intended to only be a ***starting point for customers to use as a guide to get close to proper setup for each boat.*** Due to the large variety of hull shapes, boat lengths, engine choices, prop choices, and boat loading it is nearly impossible to put together factory pre-sets that work the same on every boat. For this reason we chose a “middle of the road” setting and worked to create an easy method to modify the factory pre-sets and create individual pre-sets. The factory default pre-sets will perform different on different boats. It is highly recommended that you get the instructions and spend some time on the water in your boat. Creating the perfect wake requires managing the weight distribution in and around the boat. This is why the pre-sets are adjustable.

The system has 7 factory defaults pre-programmed in. These are just basically a sample of what the system can do. They are a starting point to developing your perfect wake in your boat. They will not be the perfect wake for your boat right out of the box.

If you ever hit restore factory defaults, or have the dealer re-flash the MTC or Viper box, you will lose all saved pre-set parameters and will need to edit the pre-sets again and save them.

MaliView Pre-Sets Screen

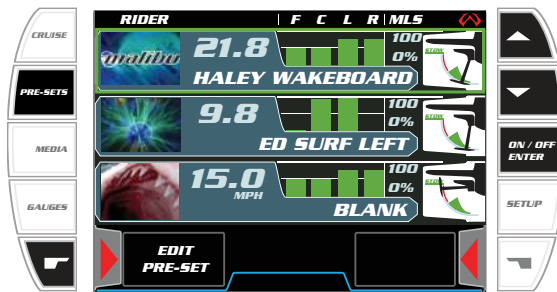

- Enter pre-sets using the “PRE-SETS” button.
- Press the “EDIT PRE-SET” button to edit the highlighted pre-set. (See *MaliView Edit Pre-Sets Screen*.)
- The up and down arrows will allow you to highlight the desired pre-set.
- Use the “ON/OFF/ENTER” button to select and activate pre-set.

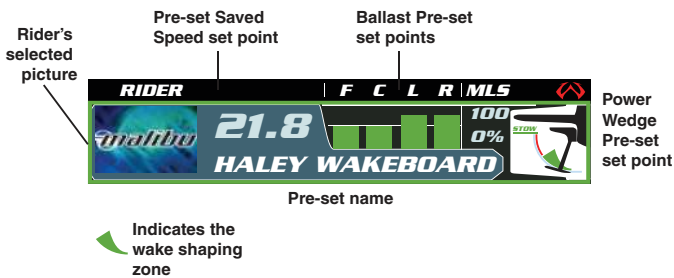

NOTES:

- The only way to stop a pre-set is to turn off “CRUISE” or change “PRESET.”
- Auto Wedge can only be turned on or off in the setup screen.
- Make sure you have a calibrated power wedge for correct operation.
- Ballast bars will disappear when the sensor is not present.
- The engine must be running for the wedge to move to a pre-set position.

MaliView Edit Pre-Sets Screen



- Press the “SAVE” button to save any changes to the pre-set.
- The up and down arrows toggle through all the options in each edit screen.
- Use the “ON/OFF/ENTER” button to toggle between edit screens and select changes.
- If no changes are needed, press the “EXIT NO SAVE” button to exit.

Name Edit Screen

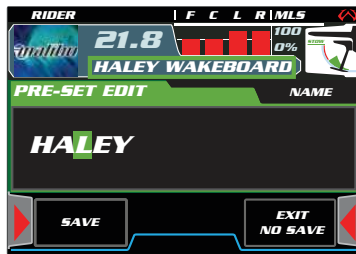

- Use the up and down buttons to change characters.
- Press the “ENTER” button to accept a character.
- There are 20 available spaces for characters.
- You must continue to press “ENTER” for all 20 spaces.

Power Wedge Edit Screen

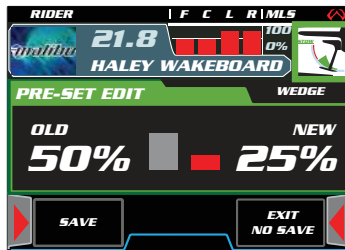

- There are 10 different “WEDGE” settings.
- Using the up and down buttons, select the desired “WEDGE” setting: “200” if fully stowed, “100” if max wedge and “0” if full down.

Speed Edit Screen

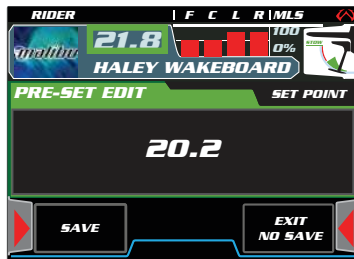

- Use the up and down buttons to change the speed.
- Press “ENTER” to accept.
- The old speed is on top, and the new speed is in the middle.

Ballast Edit Screen

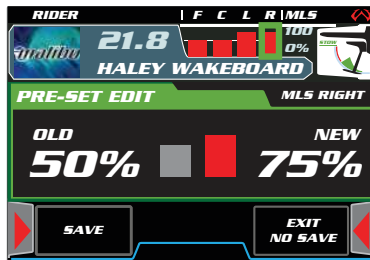

- There are 5 settings for the ballast level.
- Use the up and down buttons to change the level.
- The tank being edited is highlighted green.
- Press “ENTER” to accept the change.

Boat Alarms and Engine Faults for Mini Multi-Functional Display

Malibu Boats are equipped with two separate computers connected to many sensors and controllers that constantly monitor various functions of the boat and engine. Certain functions, if outside of a pre-determined operational parameters, may activate an alarm. When an alarm is activated, you will hear an audible buzzer alarm and see an alarm indicator in the Multi-Function LCD display. Both the engine's Electronic Control Module (ECM) and the dash Medallion Instrumentation Computer (M3) have the ability to activate an alarm.

If the Medallion Instrumentation Computer (M3) activates the alarm, you will see exactly what the fault description is in the display, such as low oil pressure, high coolant temp, low or high system voltage Depth alarm and Power Wedge over-speed. The M3 monitors these sensors independently of the ECM via the CAN link. Additional alarm parameters may be added.

The Indmar engine is equipped with the E-Control New Engine Control Module with OBD-M. If the engine ECM activates an alarm you will either see "Engine Fault" or "Service Required". "Service Required" will only be seen on engines equipped with Catalysts Emissions System for the CARB (California Air Resources Board) and EPA requirements as of June 30, 2006.

MaliView Alarm Screens

When an alarm is active, it can be disabled by pressing the bottom left button; it will return if the problem still exists after 3 minutes.



"SERVICE REQUIRED" alarm is activated by the engine ECM.



"OIL PRESSURE LOW" warning is triggered from engine ECM data.



"BATTERY VOLTAGE LOW" alarm is set when the voltage drops below 11.5 volts.



"ENGINE COOLANT TEMP" warning is triggered from engine ECM data.



The "SHALLOW WATER" alarm will appear according to the set-point in the SETUP menu.



"WEDGE FAULT PORT ACTUATOR MAXED" is a signal from the Lenco box indicating a port actuator failure or fault.



"WEDGE FAULT PORT ACTUATOR AVERAGE" is a signal from the Lenco box indicating a port actuator failure or fault.



“WEDGE FAULT UNBALANCED” is a signal from the Lenco box indicating an actuator failure, alignment or fault.



“LOSS OF CAN SIGNAL” alarm occurs when the CAN communication has stopped.



The “ENGINE FAULT” warning is triggered from engine ECM data.



The “CHECK TRANS” warning is triggered from engine ECM data for overheating.



“HIGH SPEED WEDGE DOWN” is shown when the boat is going above 25 MPH with the wedge down.



A warning for the “WEDGE MOVING” only appears when the wedge is moving up past the wake zones.



The “WEDGE FAULT STARBOARD ACTUATOR MAXED” is a signal from the Lenco box indicating a starboard actuator failure or fault.



The “WEDGE FAULT STARBOARD ACTUATOR AVERAGE” is a signal from the Lenco box indicating a starboard actuator failure or fault.



“AUTO BILGE PUMP ON” will appear whenever the auto bilge kicks on after the ignition has been turned on.



Alert banner that a left or right surf button has been pressed.



Caution banner for over speed with a Surf Gate out. The gate will automatically retract until speed has returned below 15 mph.



Error with Left RAM



Error with Left RAM



Error with Right RAM



Error with Right RAM

The “Engine Fault” alarm: Is activated by the ECM. The problem could be a momentary out of parameter minor issue **or the problem could be catastrophic**. If the “Engine Fault” alarm is activated, look at the gauges, oil P, temp and volts, and then shut down the engine, Key off, then restart. If the problem was a minor momentary, out-of-parameter fault, the fault should reset during the key cycle. If the problem is more serious, the alarm will be reactivated after restart. If the alarm continues, you should discontinue use until the problem is diagnosed and fixed.

The Medallion Instrumentation system includes OBD-M. OBD-M gives you the ability to read the Fault Codes out of the ECM using the Multi Function LCD Display. OBD-M is intended mainly for EFI Technicians to use, but would be beneficial to have it available for our customers to use if the need arises. You can at least call your dealer or Malibu and tell them what you see on the OBD-M screen.

Mini Multi-Functional Display

To Enter the On-board-Diagnostics-Marine Tool, you will need to scroll the “UP” or “DOWN” button to the “Setup” screen, then press “E (Enter).” Once in the “Setup” screen, use the “UP” or “DOWN” arrows to highlight “Service.” Press “E (Enter).” Then use the “UP” or “DOWN” arrows to highlight “Fault Codes”. You will now see two lists: **Active 1** or **Inactive 1**. It is the 1 or 0 that is important here. If the fault is currently **Active** (a real serious problem), you will see a 1 to the right of active. If the problem was a momentary out of parameter issue, you will see a “0” next to Active and you will see a “1” to the right of Inactive. Inactive means the problem is gone or has fixed itself during the reset.

If the fault Code is Active, you will want to press the “E (Enter)” button with “Active 1” highlighted in the screen. At this point you will read the Service Parameter Descriptions and DTCs in its OBD-M format.

Service Required Alarm: This alarm is present on all engines equipped with catalysts (Monsoon 350 and L96). Service Required parameters are all based on “emissions related faults.” Several of the typical sensors are now part of the emissions related faults, such as the Knock system and Ignition Control system as well as the oxygen sensors and Catalyst Monitoring system. Be advised: Per EPA and CARB requirements, any emissions related fault, even if it is no longer active, will not reset and clear the alarm until the engine has completed three complete warm up cycles from 90° to 150° F. You have the ability to use the OBD-M tool in emissions related faults also.

Turn Off the Alarm!: By turning off the alarm you are acknowledging that you know there is a problem on your boat! Press the “E (Enter)” button to disable the alarm for five minutes. The alarm will reactivate in five minutes.

Clock/Hour Display

Press the E to display the setup screen “Clock/Hour Display.” The month, day and year will be displayed. Set month first, press enter “E (Enter)” to move to the next selection; to set the day, press “E (Enter)”, then completed hour, day, then “E (Enter)”. Once the year is set, the selection will continue to set the time. Set each minute second; to move to the next screen, press “E (Enter)” up ↑ arrow. The next display panel will be shown.

Temperature

The air and water temperatures are shown on the display panel. Temperature can be displayed in either Fahrenheit or Celsius. See English/Metric operation in the SETUP menu to change view.

Depth

The depth meter will display lake depth, and can be set for shallow water alarm. To set the shallow water settings, press the “E (Enter)” on the display panel. The display will be flashing. Scroll through the settings until the desired water depth is set. The system is set to default at 2 ft. Once this is completed, press “E (Enter)” to return to main menu.

Note: The Depth graphical display only displays the bottom of the lake up to 20 feet of depth.

For boats equipped with optional depth finders, the depth system may lose its lock on the bottom if speeds exceed 20 MPH. This is normal. The depth system should reacquire the bottom once the boat has slowed to under 20 MPH.

MPH/RPM

Your dash display can also be set to display boat running speeds and RPM. If your speedometer needs correction due to changes in the system, it can be done using the MPH mode screen (see *Speed Calibration*).

Speed Calibration

The speed can be calibrated manually when the boat speed is between 15 and 36 MPH. To calibrate, scroll through the display menu to MPH/RPM. Press and hold “E (Enter)” to enter. Highlight MPH and use arrow buttons to adjust speed UP or DOWN. Press “E (Enter)” to exit. The MPH mode is all that can be recalibrated.

Malibu Cruise Control

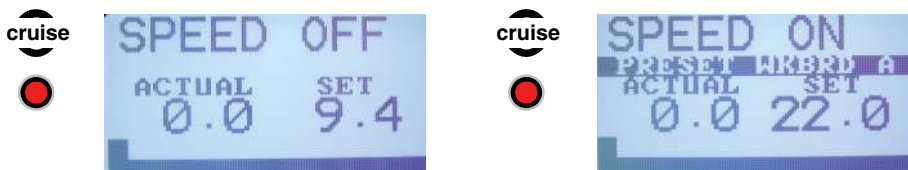
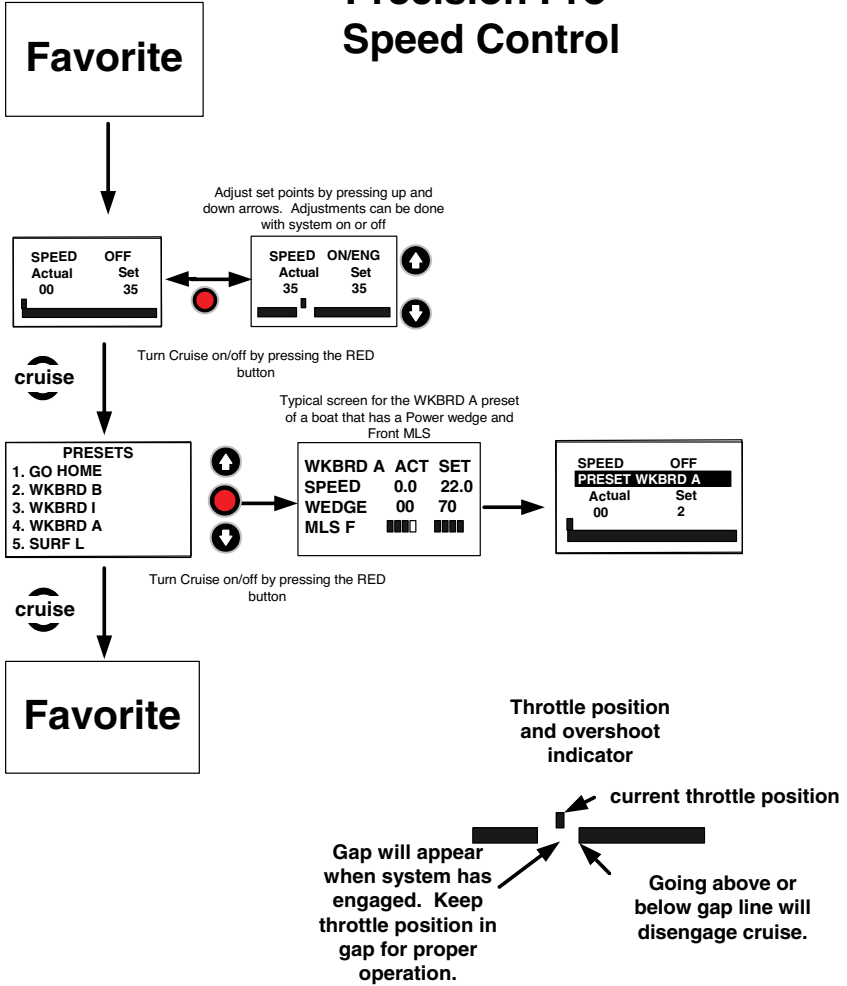

Figure 2-9. Cruise Control

Malibu Precision Pro Speed Control

Operation of Malibu Precision Pro Speed Control



In the upper port corner of the display menu is the CRUISE button. To activate, turn the engine on. While in NEUTRAL, press the cruise button on your display to engage/activate the system into speed control mode. Press the red button to turn the speed control ON. Adjust the target speed on the display if necessary with the “UP ↑” and “DOWN ↓” arrows to set your rider’s desired speed. The system’s cruise will take over when the boat speed has reached the target speed. When boat speed gets closer to the target speed, you will notice the speed control system take control of engine speed and the display will change from “ON” to “ENG” (Engaged). An audible alarm will acknowledge engagement and a window will pop up in the solid bar at the bottom of the display. This window at the bottom of the display is your throttle target window. The small square above the target window is your actual throttle position. To provide the system with the tolerance needed to maintain steady speed, adjust your throttle to position the small square in the center of the target window.

When the small square is centered in the target window, the Precision Pro Speed Control System will hold the desired target speed. If the small square is to one side of the target window, the computers will have limited authority to adjust the throttle. If throttle adjustment is needed to hold the target speed, the window will close and display “more throttle”, apply more throttle to adjust.

To disengage:

Simply pull back on the throttle. If you advance the throttle, the system will re-engage at the target speed. To turn the system off:
Press the red button in the display or turn the ignition key OFF.

With the system ON, you will be limited to target speed. However, the driver must be aware that under certain conditions it is possible to exceed target speed and therefore proper caution must be taken.

If you forget to turn the system on before you pulled the rider up, you can push the red button to turn the system ON, however you will need to reduce the boat speed to at least 6 MPH below the target speed and then back up to get the system to engage.

To exit the CRUISE display and return to the default screen, press CRUISE twice.

Note: MaliView only — If you have “CRUISE” on and turn the key off, “CRUISE” will be on the next time you turn the key on.

Note: You have the ability to set your boat up so that “CRUISE” is always on by changing your favorite screen.

MaliView Cruise Screen

Ballast Tank Levels and Fill Status

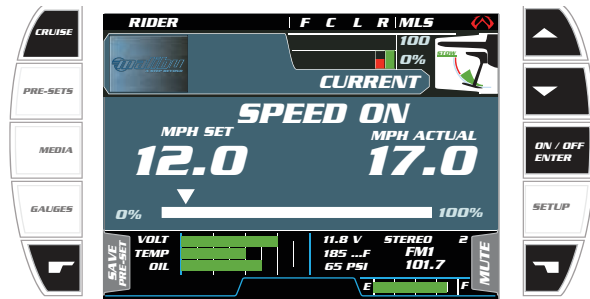
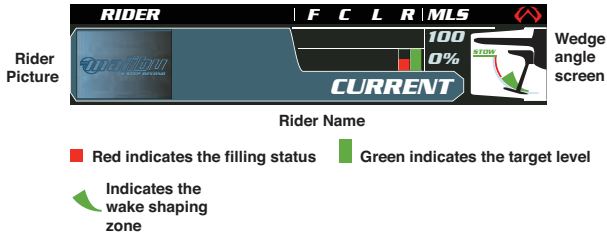

- Press “CRUISE” to enter cruise mode and to toggle between “SPEED” and “RPM” cruise modes.
- The up and down arrows will change the set-point in both “SPEED” and “RPM” cruise modes.
- Use the “ON/OFF/ENTER” button to turn the cruise on or off.
- Press “MUTE” to mute the radio.
- Press “SAVE PRE-SET” to save or edit a pre-set. (See “Pre-Set” page.) This button will also allow you to temporarily disable any alarm.



When the system has engaged, the throttle bar will turn green.



When the throttle is pushed past the ENGAGED gap, the system will give more speed as well as turn red.

NOTES:

- The gap appears when the engine has activated cruise and has control of the throttle.
- The cruise must be turned on or off when the actual speed is below the set-point.
- The cruise will only hold speed if the arrow is in the gap and is green.
- The cruise can be turned off at any time but will not disengage until the throttle has returned below the gap.

MaliView RPM Cruise Screen

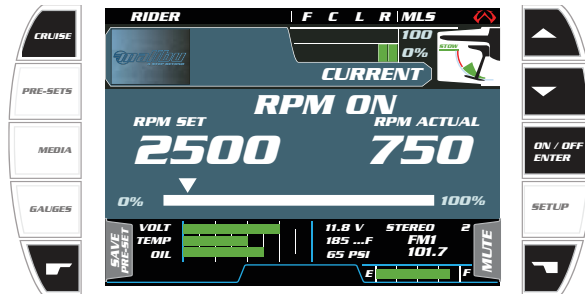

- Press “CRUISE” to enter cruise mode and to toggle between “SPEED” and “RPM” cruise modes.
- The up and down arrows will change the set-point in both “SPEED” and “RPM” cruise modes.
- Use the “ON/OFF/ENTER” button to turn the cruise on or off.
- Press “MUTE” to mute the Rockford radio. (This function only works with the Rockford radio.)
- Press “SAVE PRE-SET” to save or edit a pre-set. (See “Pre-Set” page.) This button will also allow you to temporarily disable any alarm.



When the display prompts you with “RPM PULL UP,” the system will allow full throttle control until a calculated speed has been reached.



After the calculated speed is reached, the system will automatically enter a “DECEL” mode and slowly return the engine throttle to the set RPM.



When the system has engaged, the throttle bar will turn green. Keep the arrow in the gap to allow the engine to hold the RPM.

NOTES:

- The gap appears when the engine has activated cruise and has control of the throttle.
- The RPM of the boat must be below the RPM set-point to turn on the cruise.
- The cruise will only hold RPM if the arrow is in the gap and is green.
- The cruise can be turned off at any time but will not disengage until the throttle has returned below the gap.

Power Wedge



Figure 2-10. Power Wedge



Figure 2-11. Power Wedge

The Power Wedge (PW) is an adjustable wake enlargement device designed specifically for wakeboarding. It is not intended to be used over 25 MPH. The PW alarm will activate if the foil is not in the “stowed” or “all the way up” position and the boat speed exceeds 25 MPH. You must slow down to between 1 and 10 MPH to raise the foil all the way up. The Power Wedge is intended to be deployed “down” prior to pulling up the rider; it will not deploy above 10 MPH.

Boats not equipped with PW must have the Power Wedge mode switched to N/A instead of PRESENT.

The Power Wedge is a computer controlled intelligent device. The computer determines if the boat speed is safe to operate the PW. If the boat speed and foil position are within the safe operational parameters, the computer will allow you to adjust the foil. If the boat speed and foil position are out of the safe parameters, the Power Wedge will not operate.

The Power Wedge Foil will deploy from the fully up or “stowed” position to the fully down or “operating position” as long as the boat speed is under 10 MPH. It will deploy “down” sitting on the trailer if the key is ON and the switch is depressed on the “DOWN” arrow. It will not deploy “up” unless the boat speed is between 2 and 10 MPH. Once the foil is all the way down, you will have the ability to adjust the size and shape of your wake when the boat speed is between 10 and 25 MPH. The driver should always begin the towing session with the foil in the down position. Once the boat is at the desired wakeboarding speed, the driver can increase the wake size by pressing the “UP” arrow on the PW switch in momentary increments or decrease the wake size by pressing the “DOWN” arrow in momentary increments. The driver can monitor the Power Wedge gauge for reference to the adjustments. When the boat speed is between 10 and 25 MPH, the foil will not raise above the predetermined operating limit which is the largest, sharpest, usable wake in which the foil can create. With the foil in the lowest position, the wake is comparable to approximately 400 lb of ballast in the rear of the boat.

Your Malibu can be trailered or launched with the PW down, but make sure to raise it once you are on the water. DO NOT operate the PW with people on the swim step or near the PW.

Models equipped with the Power Wedge option also have a built-in feature that monitors the condition of the Power Wedge Actuators. This feature will disable the use of the Wedge for 10 seconds to prevent damage to the Wedge while also indicating to the operator there is a fault. For boats equipped with Standard dash instrumentation, the Power Wedge gauge will “wag” to indicate a fault. For boats equipped with MaliView, see the MaliView alarm screens in previous pages to view the messages that can be displayed.

NOTICE *Be sure the wedge unit is up before loading boat on trailer.*

WARNING *Ensure all passengers are in the boat before changing wedge position. Stay clear of wedge unit while in motion. Fingers and clothing can be pinched between wedge arms and bracket, causing serious injury to passengers.*



Figure 2-12. Power Wedge

If battery power is disconnected or the battery switch turned off, the Power Wedge will need to be cycled up and down twice after reconnecting for the system to relearn the Wedge Position.

Circuit Breakers

All major boat circuits are protected from shorting and overload by resettable circuit breakers. If a problem develops with one of the following circuits, switch off the circuit and wait about one minute. Then push the appropriate breaker button fully and switch on the circuit. If the circuit continues to trip, there is a problem somewhere in the system. See your dealership immediately to locate the problem.

WARNING



If a circuit breaker continues to trip, do not hold the breaker in position to activate the electrical circuit. See your dealership immediately to locate and correct the problem before operating the boat.



Figure 2-13. Circuit Breaker Panels

Switches & Indicators



Figure 2-14. Horn Button and Power Button

For boats equipped with Malibu Touch Command, the Horn button is located on the driver's helm to the left of the steering wheel and the Power button is located to the right of the steering wheel. The Power button is used to power on the Malibu Touch Command and get access to the code entry screen to turn on the ignition and access various screens to operate the accessories. It also can be used to turn off the engine.

Malibu Touch Command System

The ALL OFF button will turn off all buttons on the current page. In the CODE screen it turns off everything but the engine.

The NIGHT button turns the interior lights to the dim level that is adjustable in the setup page.



The Malibu Touch Command system consists of 4 main screens and one optional screen. The Main screens are the CODE ENTER screen, the MLS screen, the LIGHTS screen, the SWITCH screen and the optional NAVIGATION screen.

MLS SCREEN



LIGHTS SCREEN



SWITCH PAGE



NAVIGATION PAGE



Malibu Boats equipped with the Malibu Touch Command are also equipped with a remote ignition key switch. This remote key is provided for emergency use only. Should the CAN communication link between the touch screen and the engine ECM ever fail, this remote ignition switch will allow you to start the engine. The power button must be on for this remote key switch to be active.



Figure 2-15. Remote Ignition Key Switch

Malibu Code Entry Screen

Use the KEY PAD to enter the four-digit start code. The numbers will appear on the left. The numbers will disappear when the correct numbers have been entered.

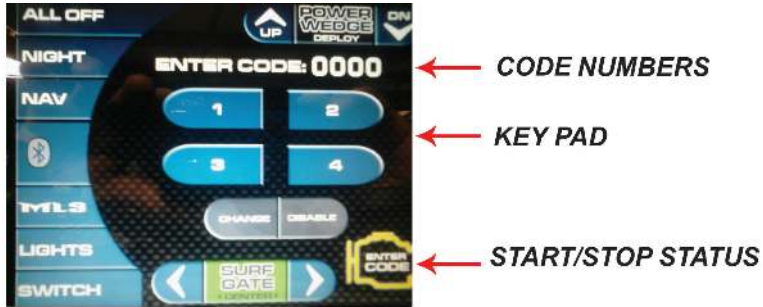

The ENTER CODE button will appear until the code has been entered.



The START button will appear after the code has been entered and will start the engine when pressed. The button must be held for a second before the engine will crank.



Press the STOP button to stop the engine without turning off the dash. The button must be held for a second before the engine will shut down.

The CHANGE button will allow the user to select a new code. This can only be done when the current correct code has been entered. Make sure to keep track of the new code number.



DISABLE/ENABLE button will allow the user to disable the code screen after the correct code has been entered. The user can enable the code by pressing the same button. This can only be done with the engine off. This feature will also require you to enter the start code.

Malibu MLS Screen

The MLS screen is set up to control the available water tanks on the boat. The user has the ability to fill or drain all the tanks at once or control the tanks individually. The tank configurations can be changed in the SETUP menu located on the SWITCH screen.



Press the FILL ALL or DRAIN ALL buttons to control all the tanks at once. If you press the ALL OFF or the OFF button the boat will stop the FILL ALL or DRAIN ALL process.

ALL OFF button is used to stop all tanks from filling or emptying.

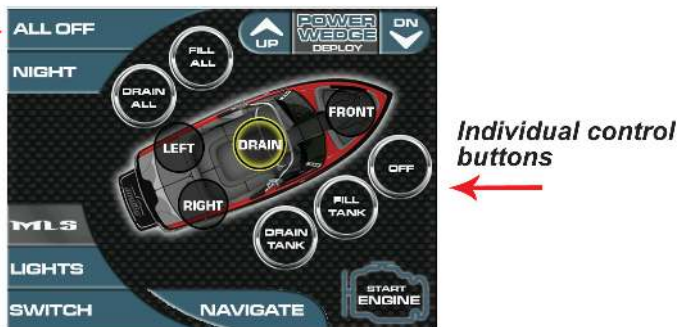

The MLS screen also allows for individual control of each tank. Press the tank button that you wish to control. Once it is pressed it will have a yellow ring indicating that it can be controlled by the DRAIN TANK, FILL TANK and the OFF buttons. Press the selected tank again to unselect.

Malibu Lights Screen

The LIGHTS screen is where all the available lights for the boat are controlled. Depending on how many lights are available on the boat a button will be displayed in approximate location of the light. Optional lights can be added or removed in the setup screen located on the SWITCH screen.

ALL OFF button
is used to turn
off all the lights.

**LIGHTS
BUTTON**



**Lights
buttons**

**START/STOP
STATUS**

The buttons will light up yellow when active. The tower lights will switch from front to rear to all as the button is pressed.



If the main power to the dash is turned off any lights that are on will turn off automatically in 10 minutes.

Malibu Setup Screen

The SWITCH screen is where all the available options for the boat are controlled. Depending on how many lights are available on the boat a button will be displayed in approximate location of the light. Optional heater switch can be added or removed in the setup screen. If the heater is removed the button will turn into an auxiliary output to be used if needed.

ALL OFF button is used to turn off all the switches.



The setup button contains some of the setup features needed for the Touch Command display and MaliView system.



All the switches have an automatic shutoff that will turn off the pumps in 5 minutes and the lights in 10 minutes after the power has been removed.

Malibu Setup Screens

The setup screen is used to keep the software up to date and adjust and troubleshoot the Touch Command/MaliView system. Use the UP and DOWN buttons to highlight the setup mode desired. Press ENTER button to access the mode highlighted.

ALL OFF
button is
used to turn
off all the
switches.



SETUP button
will bring you
back to the main
SETUP screen

Setup
Options

Pressing the ENTER button will activate the RESET TO FACTORY SETTINGS. Doing the reset is a good idea after every new software update. You may have to do some additional setup adjustments after the reset to add or subtract the options that are installed on the boat. The reset will also change your START CODE back to 1, 2, 3 and 4.

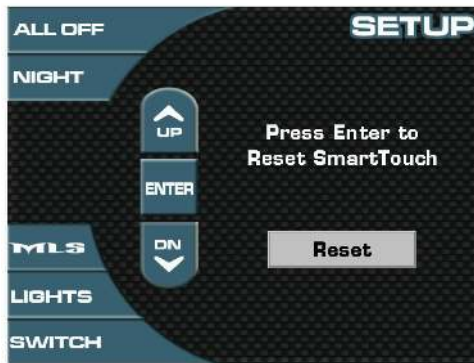

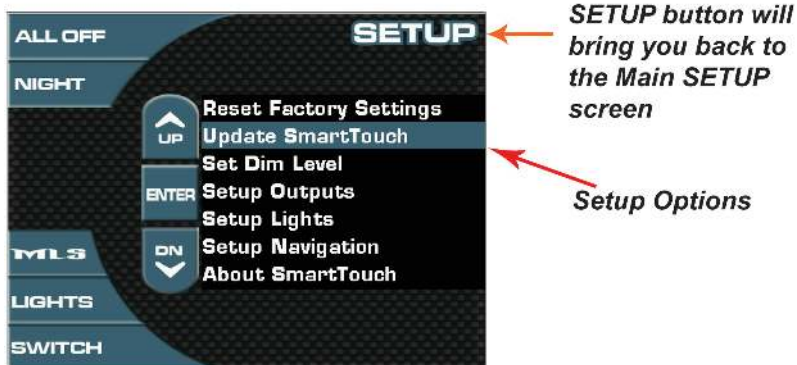

Pressing the ENTER button will activate the UPDATE TOUCH COMMAND mode. The UPDATE will read a USB and load the SmartTouch.mem file. The update will not work unless the file is named SmartTouch.mem. The system will reset automatically when complete. The UPDATE can also be done by just turning off and on the power with the USB stick attached to the Touch Command USB port.

NOTICE Only an authorized dealer should attempt to load software.



Malibu Set Dim Level Screens

The setup screen is used to keep the software up to date and adjust and troubleshoot the Touch Command/MaliView system. Use the UP and DOWN buttons to highlight the setup mode desired. Press ENTER button to access the mode highlighted.

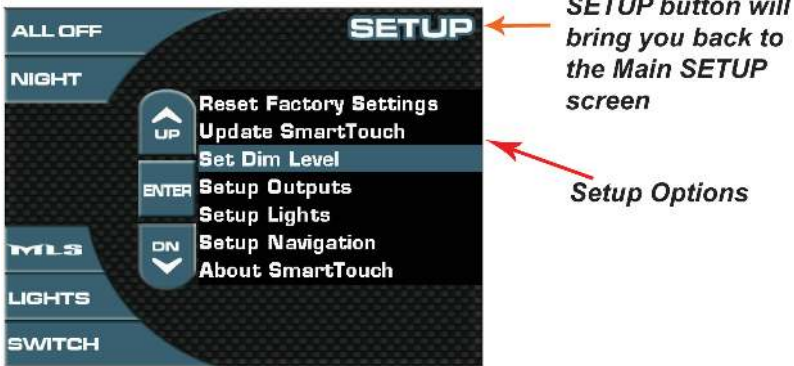

Pressing the ENTER button will activate the BACKLIGHT DIM LEVEL mode. Once activated use the UP and DOWN buttons to set the desired dim level. This will determine how dim the DASH and INTERIOR lights will be when the NIGHT button is pressed.

The NIGHT button will dim the dash and interior lights to the set dim level. Press the button again to return to 100% on.



Malibu Setup Outputs Screens

The setup screen is used to keep the software up to date and adjust and troubleshoot the Touch Command/MaliView system. Use the UP and DOWN buttons to highlight the setup mode desired. Press ENTER button to access the mode highlighted.



SETUP button will bring you back to the Main SETUP screen

Setup Options

Pressing the ENTER button will activate the SETUP OUTPUTS mode. Turning on and off ballast will change the appearance of the MLS screen. If the heater is removed the heater button will indicate AUX. This will allow what was the heater button to be used. The heater output on the Primary power module can be used with the new AUX button.



Highlight the output you wish to turn on or off. Press the ENTER button to change its status.

Malibu Setup Lights Screens

The setup screen is used to keep the software up to date and adjust and troubleshoot the Touch Command/MaliView system. Use the UP and DOWN buttons to highlight the setup mode desired. Press ENTER button to access the mode highlighted.

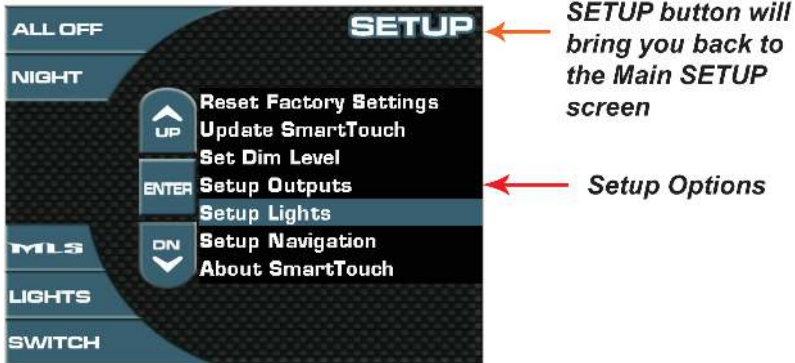

Pressing the ENTER button will activate the SETUP LIGHTS mode. Turning on and off lights will change the appearance of the LIGHTS screen. If the TOWER is removed the image of the boat will have no tower.

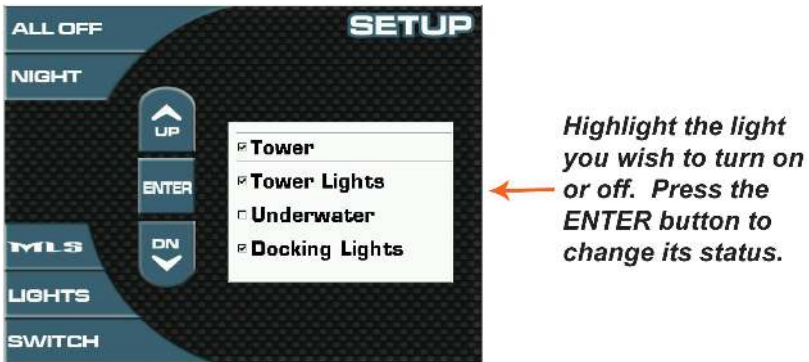

Malibu Setup Navigation Screens

The setup screen is used to keep the software up to date and adjust and troubleshoot the Touch Command/MaliView system. Use the UP and DOWN buttons to highlight the setup mode desired. Press ENTER button to access the mode highlighted.

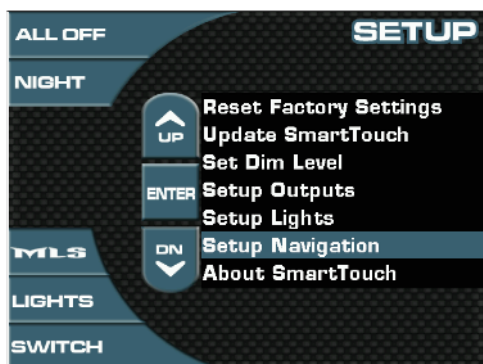

SETUP button will bring you back to the Main **SETUP** screen

Setup Options

Pressing the ENTER button will activate the NAVIGATION mode. Refer to the NAVIGATION manual for complete NAVIGATION operation. Once active a navigation button will appear on all the main screens. Make sure this is a valid option on the boat. It can be added at any time.



Highlight the Navigation option. Press the ENTER button to change its status.

Malibu About Touch Command Screens

The setup screen is used to keep the software up to date and adjust and troubleshoot the Touch Command/MaliView system. Use the UP and DOWN buttons to highlight the setup mode desired. Press ENTER button to access the mode highlighted.

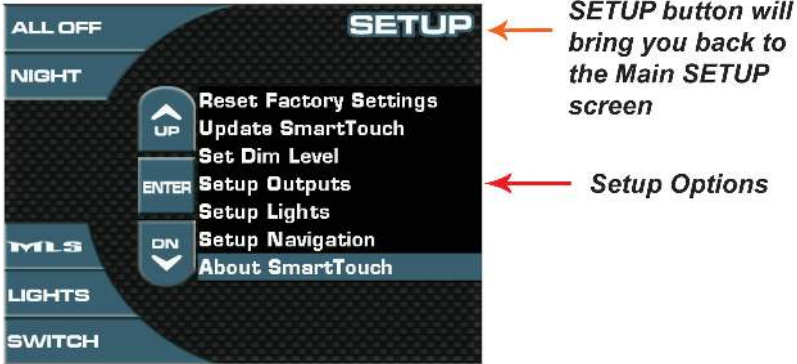

Pressing the ENTER button will allow you to view the current software version in the Touch Command display.

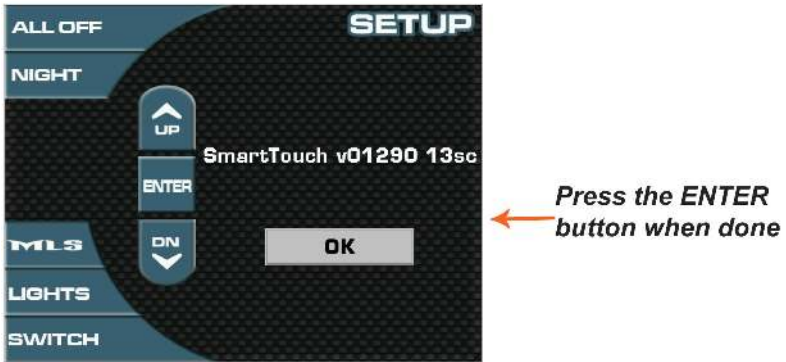

Accessory Switch Panels

These panels are located in the dash directly below the standard gauges and are used to activate the following features. You will find the feature or accessory provided within each button face for description.

- Horn
- Navigation Lights
- Interior Lights
- Accessory Docking Lights
- Accessory Tower Lights
- Accessory Shower
- Accessory Malibu Launch System (MLS)
- Accessory Stereo
- Accessory Heater
- Bilge Pump
- Blower

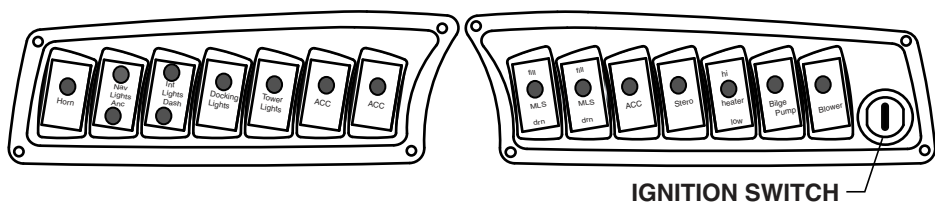

mal-06-015

Figure 2-16. Ride Series and Response/LX Switch Panel

Bilge Pump

The bilge pump switch is used to activate the bilge pump so that any excess water in the bilge area may be drained out. You should know that the bilge pump has a sensor in the bilge area and will turn on automatically whenever 2 in. or more of water is detected.

The bilge pump is wired directly to the battery. This circuit can be identified by an inline fuse from the battery labeled “Auto Bilge Power.”

Blower

This switch activates the blower for the engine compartment. The primary function of the blower is to eliminate any fumes in the motor compartment prior to starting the engine and while operating below cruising speed.



Figure 2-17. Inline Fuse

WARNING



Gasoline Vapors Can Explode. The U.S. Coast Guard specifies that the bilge blower must be operated for a minimum period of 4 minutes PRIOR to starting the engine to remove fuel fumes from the bilge area. Run blower below cruising speed.

Stereo Power

The optional stereo system can be activated by either turning the ignition key on, or can be used without the engine started by turning the key to the left position; for boats equipped with Malibu Touch Command, the power button will turn on the stereo.

Accessory #1

This switch is used to supply power to the optional heater unit. (For information on the use of the heater, please see heater operation in the optional equipment section of this manual.)

Accessory #2

This switch is used to supply power to the optional hot water shower. (For information on the use of the hot water shower, please see hot water shower usage in the optional equipment section of this manual.)

Interior Lights

This switch is used to activate the interior lights. The interior lights include lights in the gunnels, storage compartments and dashboard, and optional underwater transom lights, if equipped.

Navigational Lights

















In the ANC (anchor) position, this switch is used to activate the all-around light at the end of the pole when inserted in the connector on the deck or on the tower, if equipped. Keep the all-around light on after dusk whenever your boat is at rest in the open waterway. While underway, place the switch in the NAV position to also activate the red and green navigation bow lights.

Optional Rear MUX Switch

Some models have an optional rear MUX switch module available. These modules have the ability to have any function added, subtracted or moved. This makes the boat a lot more flexible when adding or deleting options from the switches.



Figure 2-18. Optional Rear MUX Switch

	Pressing the BILGE button will toggle the POWER module output and MUX display from OFF to ON and back to OFF again.
	Pressing the DASH LIGHTS button will toggle the POWER module output and MUX display from OFF to ON to DIM 1 to DIM2 and back to OFF again. DIM 1 and 2 are two lower levels of brightness for the dash. DIM2 will also turn off the MaliView screen on boats with this option.
	Pressing the INTERIOR LIGHTS button will toggle the POWER module output and MUX display from OFF to ON to DIM 1 to DIM2 and back to OFF again. DIM 1 and 2 are two lower levels of brightness for the boat.
	Pressing the BLOWER button will toggle the POWER module output and MUX display from OFF to ON and back to OFF again.
	Pressing the NAV/ANC LIGHTS button will toggle the POWER module output and MUX display from OFF to NAV/ANC ON to NAV ON and back to OFF
	Pressing the HEATER button will toggle the POWER module output and MUX display from OFF to HIGH to LOW and back to OFF again.
	Pressing the MLS LEFT button will toggle the POWER module output and MUX display from OFF to FILL to OFF to DRAIN and back to OFF again.
	Pressing the MLS RIGHT button will toggle the POWER module output and MUX display from OFF to FILL to OFF to DRAIN and back to OFF again.
	Pressing the MLS CENTER button will toggle the POWER module output and MUX display from OFF to FILL to OFF to DRAIN and back to OFF again.
	Pressing the MLS FRONT button will toggle the POWER module output and MUX display from OFF to FILL to OFF to DRAIN and back to OFF again.
	Pressing the TOWER LIGHTS button will toggle the MINI MMDC module output and MUX display from OFF to FRONT to ALL and back to OFF again. The ignition must be on for this to function.
	Pressing the DOCKING LIGHTS button will toggle the POWER module output and MUX display from OFF to ON and back to OFF again.
	Pressing the POWER WEDGE DEPLOY button will toggle the MINI to move the WEDGE to its down position. This is done automatically once the button is pressed. The POWER module will turn off after it has reached the bottom or 10 seconds has elapsed.
	Pressing the POWER WEDGE DOWN button will toggle the POWER module output to supply power to the WEDGE to move it down. The WEDGE will move down as long as this button is pressed.
	Pressing the POWER WEDGE UP button will toggle the POWER module output to supply power to the WEDGE to move it up. The WEDGE will move up as long as this button is pressed and the boat is moving faster than .3 mph.
	The AUX OUTPUT icon will toggle on and off a 12-volt source on the POWER module. This is intended to drive a relay for controlling things like on/off power for amps and other devices.
	The output is located in position #1 on the POWER module.

Function Edit Mode

Enter Function Edit

1. Hold **PAGE**, button #4, and button #5 at the same time for 3 seconds.
2. Press button **1(YES)** to enter edit mode or **2(NO)** to exit edit mode.
3. Press the **PAGE** button to switch between the edit modes **CHANGE**, **DELETE**, and **INSERT**.

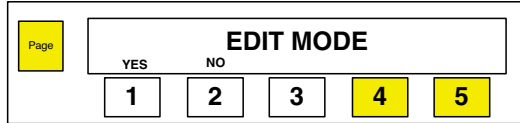

Change Mode

1. Press button **1(YES)** to enter **CHANGE** mode or **2(NO)** to exit edit mode.
2. If **1(YES)** is pressed return to icon page in change mode. If you do not change a button and cycle through all the pages by pressing the page button you will also exit the edit screen.
3. The user can press one of the button to be changed. Every time that button is pressed scroll through all the loaded icons.
4. Once an function/icon is selected hold down the button for 3 seconds to lock it in.
5. After lock in return to **CHANGE** edit mode screen.

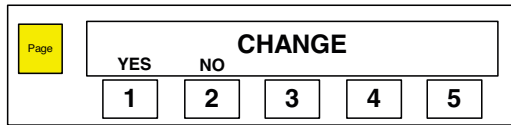

Delete Mode

1. Press button **1(YES)** to enter **DELETE** mode or **2(NO)** to exit edit mode.
2. If **1(YES)** is pressed return to icon page in **DELETE** mode. If you do not change a button and cycle through all the pages by pressing the page button you will also exit the edit screen.
3. The user can press one of the button to be changed. Every time that button is pressed scroll through all the loaded icons.
4. Once an function/icon is chosen hold down the button for 3 seconds to **DELETE** that function/icon.
5. After deletion all functions/icons should shift to the left to fill in gap.
6. After deletion return to **DELETE** edit mode screen.

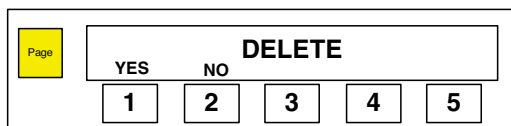

Insert Mode

1. Press button **1(YES)** to enter **INSERT** mode or **2(NO)** to exit edit mode.
2. If **1(YES)** is pressed return to icon page in **INSERT** mode. If you do not change a button and cycle through all the pages by pressing the page button you will also exit the edit screen.
3. The user can press one of the button to be changed. Every time that button is pressed the mux switch will show a different icon.
4. Once an function/icon is chosen hold down the button for 3 seconds to **INSERT** that function/icon.
5. After insertion all functions/icons should shift to the right.
6. After insertion return to **INSERT** edit mode screen.

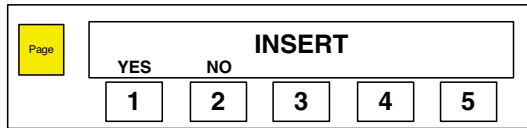
**Factory Default Mode**

1. Press the **PAGE** button and Button #1 and #2 for 3 seconds to enter **RETURN TO FACTORY DEFAULT** mode.
2. If **1(YES)** is selected the all the functions and icon locations will return to factory settings.
3. If **2(NO)** is selected the switch module will return to normal operations with no changes.

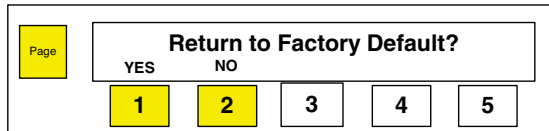

Throttle Control

The throttle lever is located to the right of the driver (Figure 2-19). When the throttle lever is vertical, it is in the NEUTRAL position. The throttle lever is equipped with a neutral shift lock activation button. Depressing the neutral shift lock activation button and lifting up on the safety collar disengages the transmission, thereby allowing use of the throttle without engaging the transmission. This is used for warm-up of the engine in NEUTRAL. The throttle control is equipped with an indicator light that illuminates when the neutral shift lock is engaged.



Figure 2-19. Throttle Lever

Be sure to position the throttle vertically (in NEUTRAL), before re-engaging the transmission, by depressing the neutral shift lock activation button.

WARNING



Do not shift from forward to reverse at high RPMs; damage to the transmission will result. When shifting from forward to reverse you must stop in the NEUTRAL position, doing this allows the engine to run in its idle position before moving into the opposite gear. Moving the shift lever from FORWARD to REVERSE without stopping in NEUTRAL can cause the transmission to “slam” into gear, damaging the transmission and/or causing the engine to shut off. This will cause temporary loss of boat control which can cause damage and/or injury to the boat and/or persons in or around the boat.

WARNING



Before starting the engine or engaging transmission, ensure all swimmers are out of the water.

Electronic Throttle Control (ETC)

All current Malibu Boats are equipped with electronic throttle control. The helm throttle control “E-MV3” is now dual, variable voltage potentiometer that sends electronic signals back to the engine ECM via a shielded wire harness with the highest quality water-tight connectors that mates to the engine ECM. The ECM then uses the signals from the E-MV3 to precisely control the engine speed with an electronic throttle body. Do not make any modifications to the throttle control to ensure proper operation.

Throttle failure: If for any reason, any part of the electronic throttle control system fails; (unplugged, wire cut, short, loss of power, sensor failure) the engine controller will default to “Idle.” You will have “no” control of the throttle, the “Engine Fault” alarm will also be activated. If this ever happens; turn the key OFF and then restart. This will reset the computer area network. If this condition continues, take the boat to the dealer.

For more information regarding the safe operation and maintenance of the throttle control, refer to the separate instructions located in the information packet shipped with your boat.

Steering System

It is important that you get the “feel” of your Malibu boat’s steering system. Turn the wheel from full left to full right, and make sure the rudder is turning accordingly. The system should operate freely and smoothly. See *Malibu Exclusive Adjustable Rudder System* in Chapter 3 for rudder adjustment.

NOTICE *It is normal for your Malibu steering to pull slightly to the right under normal driving conditions.*

Emergency Engine Stop Switch

The emergency stop switch attaches to the operator of the boat and shuts down the engine if the operator is accidentally forced away from the helm.

The switch consists of an ON/OFF switch and a switch clip/lanyard clip, which is connected between the stop clip and the operator. Should the operator move away from the controls, the clip pulls free, flipping the switch to the OFF position and stopping the engine. If the engine must be shut down quickly, a pull on the lanyard cord to release the clip from the switch will stop the engine.

To reset the switch after activation, reinstall the lanyard clip and flip switch to the UP position.



Figure 2-20. Emergency Engine Stop Switch

Engine Compartment Fire Extinguisher

Your boat is equipped with a Fireboy® Fire Extinguishing System. The extinguisher is mounted in the engine compartment.

The fire extinguishing system is activated when the key is turned to the ON position. An indicator light mounted next to the emergency safety lanyard will illuminate green, indicating the fire extinguishing system is activated.



Figure 2-21.



Figure 2-22.

WARNING



Do not start the engine if the indicator light does not illuminate green when the key is in the ON position. See your dealership immediately to locate the problem.

The extinguisher is equipped with a pressure gauge indicating the level of charge. Inspect the pressure gauge daily before starting the engine.

If the gauge indicates RECHARGE, service the fire extinguishing system before operating the boat.

WARNING



Do not operate the boat if the fire extinguishing system requires service. See your dealership immediately to service the system.



Figure 2-23.

The fire extinguishing system will automatically actuate when the sensor on the extinguisher detects the temperature in the engine compartment reaches 175°F.

When actuation occurs:

- Immediately shut down the engine, powered ventilation and electrical systems.
- Extinguish all smoking materials.
- Do not open the engine compartment.

After actuation:

- Before inspecting for damage, allow the agent to “soak” the compartment for at least 15 minutes and wait for hot metals or fuels to cool.
- Have an approved portable fire extinguisher in hand and ready to use.
- Do not breathe fumes of vapors cause by the fire. They are hazardous and toxic.

NOTICE *For additional fire extinguishing system information and safety concerns, refer to the Fireboy® owner’s manual in the information packet shipped with your boat.*

Motorbox Cover

The upholstered motorbox reduces engine noise and provides protection for the passengers on board. To open, stand on the port side of the box near the observer seat, grasp the handle near the floor and pull open. The motorbox is equipped with either one or two gas-filled shock absorbers (depending on model) to provide support for the compartment when opened.



Figure 2-24. Motorbox – Direct Drive Models

WARNING

Running the engine with the motorbox open exposes rotating machinery which can cause injury to occupants of the boat.

Driver’s Seat

The driver’s seat can be adjusted forward and backward by pulling the lever located on front left side of the driver’s seat. Pull lever outward and adjust seat as needed.

Lumbar Support

The driver’s seat is equipped with a Lumbar Support. To adjust, locate the twist knob located on the left side of the seat bottom. Turn the knob clockwise to increase lean back tension, or counterclockwise to decrease tension.

**Swivel Seat Base**

Some models are also equipped with a swivel seat adjustment. To adjust the seat, release the lever directly below the front center of the driver’s seat. The seat should swivel freely. To reset the seat position, simply reverse these steps. For boats with the optional fiberglass floor, the lever to allow the seat to swivel is located on the rear, left corner of the driver’s seat.



Figure 2-25. Bolster Seat



Figure 2-26. Lumbar Adjuster



Figure 2-27. Seat Adjuster

Integral Self Draining Ice Chest

This item is available on most model boats and can be found either in the starboard passenger seat or center floor. Some models also have an insulated removable bag. For models with a built-in cooler, the water will drain into the bilge area of your boat.

Sundeck

Most boat models are equipped with a standard sundeck feature designed for sunbathing comfort.

WARNING



The Sundeck is not to be used while the engine is running. Serious injuries or death could occur to persons not seated properly should the boat come to an abrupt halt.



Figure 2-28. Sundeck

V-Drive Engine Access Hatch

An engine access hatch is located behind the rear observers' seat on the V-Drive. Access allows the ability to service the engine for required maintenance and for additional storage on both sides of the engine.

WARNING



Ensure the hatches are securely latched. Failure to do this could allow your engine hatch door to open while under way causing damage to your boat and others.



Figure 2-29. Engine Access Hatch

Ski Pylon

The patented, pivoting-head ski pylon is an aluminum post located directly in front of the motorbox. V-Drive models feature a telescopic version. Minimal maintenance is required, but once a year remove the swivel pylon head and re-grease with a high temperature bearing grease. This will reduce wear. To use the telescopic version, pull pylon up, rotate clockwise and lower until in locked position.

WARNING



Malibu Boats' "Pivoting-Head" ski pylon is designed for normal water skiing activities: slalom, jumping, kneeboarding, tricks, and barefooting. Any other uses such as parasailing, kite flying, towing pyramids of skiers, etc., may over-stress the pylon and possibly cause personal injury and/or equipment damage. DO NOT overload the pylon or use it for anything other than watersports.



Figure 2-30.
Pivoting-Head
Ski Pylon

Swim Platform

A removable swim step is located on the stern of the boat to provide easy access into and out of the water for boat skiers and swimmers. To remove, rotate the latches away from the transom and align the pin with the notches to pull it out. Depending on model, either lift or slide back on the platform. To replace, reverse these steps. Be sure the latches are securely fastened.

WARNING



DO NOT use the boarding platform for any other purpose than boarding the boat or preparation of entering the water, and DO NOT use the boarding platform when the engine is running.



Figure 2-31. Swim Platform

WARNING



A spinning propeller or carbon monoxide can cause serious injury or death. Stay off and keep away from boarding platform while engine is running. The boarding platform must be attached when the boat is in use.



Figure 2-32. Swim Step Pin
Removal

To access the optional swim step ladder, lift up on the handle of the rubber strap to unhook it then pull it down and pull the ladder out. To replace, reverse these steps. Make sure the swim step locks are fully locked before launching the boat.



Figure 2-33. Swim Step Ladder Strap

Navigational Lights

As required by the U.S. Coast Guard and most maritime authorities, all recreational vessels are required to display navigational lights between sunset and sunrise and other periods of reduced visibility. All Malibu Boats are equipped with bow and all-around navigational lights.

The bow light located at the tip of the bow is two colored — red and green, and is used to keep others aware of your presence when operating your boat at night.



Figure 2-34. Bow Light

A covered, two-pronged connector can be found on the top of the transom on boats without a tower. The all-around light is plugged into this connector when needed and stored under the rear passenger seat when not in use. Boats equipped with towers have an all-around light fitted to the top of the tower.

CAUTION



The bow light will get hot upon illumination, which can cause burns if touched. The light can stay hot for an extended period of time after it has been turned off.

Go Home Feature

The “Go Home” feature will enable the navigation lights (bow and tower) to illuminate whenever the driver uses the hard-key to start the engine instead of the touch screen.

Storage Areas

Bow Storage Area

Access to a large storage area located in the bow of all models is accessible by lifting the bottom-lifting strap of the observers' seat back. The size of the storage differs between open and closed bow versions. On open bow boats the seat cushions can be removed to provide additional storage.

Gunnel Ski Storage

Conveniently located on both sides of the boat, these storage areas are ideal for the storage of water skis, and other items.

Floor Ski Storage

Located on the floor between the driver's and observers' seats on some models with walk-through, is a panel that when lifted provides access to a large area that can be used primarily for storage of water skis.

Transom Storage

Some boat models are equipped with transom ski storage. Depending on the model, the storage is accessible from either the interior by lifting the observers' seat or from the transom swim platform by lifting the hatch cover.



Figure 2-35. Transom Storage – Direct Drive Models

Glove Box Storage

Located on the port side of the boat above the observers' seat for easy access and storage. This small area can be used to store registrations, tools, wallets, cell phones, etc.



Figure 2-36. Glove Box Storage

NOTICE

The glove box is not water-tight. To prevent water damage to paperwork and/or electronics, we suggest placing electronics such as cell phones and I-pods in a ziplock bag to prevent damage from rain or water over the bow.

VTX Table Installation

The 2014 VTX comes equipped with the side-mounted table. To install:

1. Remove the table top from the transom storage and the table support pole from under the port-side pull-up cushion.
2. Slide the base of the pole into the mounted receiver.
3. Place the table receiver onto the top of the pole.

Reverse the process to stow the table away.

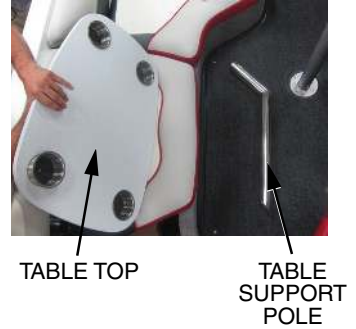

Figure 2-37. Table Top and Table Support Pole



Figure 2-38. Mounted Receiver

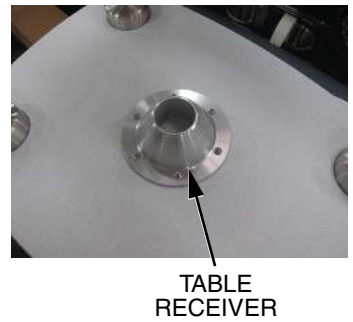

Figure 2-39. Table Receiver

Drain Plugs

Your Malibu is equipped with two or three drain plugs; one located at the transom of your boat and the other directly below your engine/drive train. On the walkthrough open bow models, you will find an additional drain plug in the ski locker or ballast area of your boat directly in line with your ballast pumps.

Transom Drain Plug

This plug is located in the center of the transom at the bottom edge, and is provided to allow for drainage of the bilge area, when needed.



Figure 2-40. Transom Drain Plug

NOTICE *Ensure all drain plugs are secure prior to launching your boat. Damage caused as a result of these plugs not being installed will not be covered under your Malibu warranty.*

Bilge Drain Plug(s)

A T-handled, brass bilge drain plug is located in the engine compartment of all models. Location is normally directly below the drive-train unit. To access, lift motorbox and look aft of the ski-tow pylon, and forward of the engine. On the V-drive models, the T-handle can be found by lifting the rear passenger seat. The T-handle is located just below the V-drive unit.



Figure 2-41. Bilge Drain Plug

NOTICE *Ensure that all transom and bilge drain plugs are securely in place before placing the boat in the water.*

Speedometer Pickup

Your boat is equipped with a Paddle wheel speedometer pickup, which can be found directly under the running surface of your boat. The paddle wheel is used to measure static water by rotation of the paddle wheel unit. The paddle wheel unit also monitors the Water Temperature unless a Depth Transducer is installed (which will then assume the responsibility to measure Water Temperature). This information is transferred to the dash computer and a computer program converts information which is transferred to the speedometer gauge.

See *Troubleshooting* section of this manual for basic maintenance information.



Figure 2-42. Thru-Hull Paddle Wheel Pickup

Tilt Steering Wheel

The tilt steering wheel allows for maximum driver comfort. To adjust the height of the wheel, simply press down on the lever located under the wheel. Move the wheel to the position that is most comfortable. When the wheel is in the desired position, simply release the lever to lock the wheel in place.

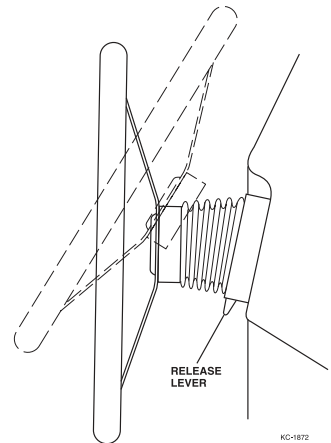

Figure 2-43. Tilt Steering

Exhaust

The exhaust system is used to remove engine exhaust fumes. To ensure that your boat's exhaust system is working correctly, it is important that you inspect for exhaust leaks. The following information will allow you to check these systems. Keep in mind that you will be checking engine while turned on, and that you will need to take safeguards against getting yourself or others caught in the moving parts. Use extreme caution while performing this task.

- Turn engine off and disconnect the engine safety switch. Be sure the throttle shift control is neutral. The engine must be cool.
- Open the engine hatches and check the exhaust system from the engine to the transom for obvious damage.
- Reinstall engine safety switch and start the engine with engine compartment open. Check hose connections between the exhaust manifolds and the muffler for leakage.
- If leakage is apparent, tighten the hose clamps, being careful not to crimp the hose. See your Malibu dealer for parts and or service.

NOTICE

The Monsoon and L96 engines equipped with the ETX Catalyst Exhaust Manifolds may produce an unusual smell which is characteristic of an engine with a catalyst exhaust system.

WARNING



Allow the catalyst exhaust manifolds to cool before touching them. While the engine is operating and right after turning the engine off, the manifolds are extremely hot and will burn the skin.

Ventilation

The ventilation is used to remove potentially hazardous accumulation of explosive vapors from the bilge areas of your boat's hull and engine compartment. Therefore, proper ventilation is essential to the safety of the boat and persons in or around the boat structure.

Your boat is equipped with a ventilation system that will ensure complete removal of these dangerous fumes. However, it is your responsibility as the operator of the boat to ensure these systems are working efficiently. The boat's primary source for expelling fumes from the boat is the blowers located in the bottom of the bilge and at the transom venting points.

Your boat is also equipped with a natural air-intake that forces air through a venting system on the deck of your boat, and channels air from the bilge to the transom vent.

Closed Cooling System

If your boat is equipped with an optional closed cooling system, you will need to maintain correct fluid levels.

- Open engine compartment and remove reservoir cap.
- Ensure coolant is to the top of the reservoir filler neck.
- Use Sierra Anti-Freeze.

NOTICE

To ensure we are always mindful of our environment, Malibu Boats recommends the use of Sierra Brand antifreeze because of its propylene glycol formulation. SIERRA Antifreeze is less toxic and safer than ethylene glycol coolants to children, pets and wildlife, in case of spills, leaks, boil-over or careless disposal.

CAUTION



The engine must be cool when checking the coolant level. Hot coolant and steam under pressure may cause injury.

NOTICE

For specific engine information including its warranty, refer to the engine's owner's manual in the information packet shipped with your boat.

Optional Equipment

Heater

If your boat is equipped with a heater, you will find an ON/OFF accessory switch located on the dash panel. Located at the base of the observer seat walkway is a snorkel tube that can be pulled out and directed wherever you like within a five-foot radius. Please refer to the information provided in your owner's packet for specific use.



Figure 2-44. Heater

Boat Cover

If your boat is equipped with this option, know the type of cover you are placing on your boat. Some Boat Covers have been made strictly for mooring and storage only, and some have been made for storage and travel. If you question the type of cover that you have purchased, check with your Malibu dealer for assistance. Do not cover the boat if the interior is wet or damp. This can promote mildew growth.



Figure 2-45. Boat Cover

Malibu offers gray boat covers for which the Limited Warranty is administered by their manufacturer. No other color is offered by Malibu, and if another color is used, the cover and upholstery warranty will be voided.

NOTICE *Damage caused to your boat as a result of improper cover use is not covered under your Malibu Boats warranty. Damage can result from wind whipping, and possibly cause abrasions to your gelcoat surface or upholstery. Use the proper shipping cover for travel purposes. Usage of any color boat cover other than the factory gray will void the upholstery warranty.*

NOTICE *Warranty coverage for your boat's cover, canvas or bimini is not included in the Malibu boat warranty. For warranty assistance for these items, contact the manufacturer directly.*

Stereo (N/A for Touch Screen)

To turn the stereo on, the ignition must be turned on. If equipped, the key can be turned to the left if you will not be running the boat. Some systems, if equipped, will have an optional remote pad located at the back of the boat either in the passenger area, or exterior transom. For specific stereo use, please refer to the stereo manual that was included in your owner's packet. Standard on all boats equipped with stereo system is an MP3 input line. See instructions found in your owner's packet for specific use.

If your boat was equipped with optional sound equipment to include amplifier or subwoofer, please refer to these specific manuals included in the owners' packet for use.



Figure 2-46. Stereo



Figure 2-47. Optional Transom Remote

Stereo Controls

When in the radio screens, the left and right buttons will respond to the label directly inside the button. For example, the CRUISE button is now the BACK TO VIPER button in all PAGE 1 screens in every mode.

Fosgate FM/AM Radio Screens

BACK TO VIPER will return the system to the last non radio screen

Preset Scan will cycle through the saved presets

The **VIDEO** button will toggle through the active video screens

PAGE 2 will switch the screen to the second page of this mode

The **MODE** button will switch the radio to the next mode



Use the **UP** and **DOWN** buttons to raise and lower the volume

The **SEEK** left and right buttons will tune up and down stations

To **MUTE** the volume press the **MUTE** button. Press again to unmute

Select a saved preset by pressing 1 through 4. You can save the preset by holding the preset button down.

The **MODE** button will switch the radio to the next mode



Use the **UP** and **DOWN** buttons to raise and lower the volume

To switch to **FM2**, **FM3**, **AM1**, and **AM2** press the **BAND** button

PAGE 1 will switch the screen to the first page of this mode

Enter the **Base**, **Treble**, **Fade**, and **Balance** edit mode by using **SELECT**

AUX Radio Screens

BACK TO VIPER will return the system to the last non radio screen

POWER button

The **VIDEO** button will toggle through the active video screens

The **MODE** button will switch the radio to the next mode



Use the **UP** and **DOWN** buttons to raise and lower the volume

To **MUTE** the volume press the **MUTE** button. Press again to unmute

Fosgate USB DRIVE Radio Screens

BACK TO VIPER will return the system to the last non radio screen

PAUSE PLAY Pause the music by pressing once and a second time to continue

VIDEO The VIDEO button will toggle through the active video screens

PAGE 2 will switch the screen to the second page of this mode

MODE The MODE button will switch the radio to the next mode



Use the UP and DOWN buttons to raise and lower the volume

The SEEK left and right buttons will tune up and down songs.

To MUTE the volume press the MUTE button. Press again to unmute

A short press of the **SELECT** button will allow the audio to be adjusted for bass, Treble, balance, and fade. A long press will turn on the COPY mode.

Power for the radio

The **VIDEO** button will toggle through the active video screens

PAGE 1 will switch the screen to the first page of this mode.

The **MODE** button will switch the radio to the next mode



In normal mode the up/down buttons control volume. In FOLDER mode it will toggle through folders.

Display will toggle the available information for the songs.

Put the radio in the random play mode

PAGE 1 will switch the screen to the first page of this mode

SIRIUS Radio Screens

BACK TO VIPER will return the system to the last non radio screen

Power button

The **VIDEO** button will toggle through the active video screens

PAGE 2 will switch the screen to the second page of this mode

The **MODE** button will switch the radio to the next mode



Use the **UP** and **DOWN** buttons to raise and lower the volume

The **SEEK** left and right buttons will tune up and down stations

To **MUTE** the volume press the **MUTE** button. Press again to unmute

Select a saved preset by pressing 1 through 4. You can save the preset by holding the preset button down.

Power Button



Use the **UP** and **DOWN** buttons to raise and lower the volume

Change the displayed information

PAGE 1 will switch the screen to the first page of this mode

Enter the Base, Treble, Fade, and Balance edit mode by using **SELECT**

Fosgate IPOD Radio Screens

BACK TO VIPER will return the system to the last non radio screen

PAUSE PLAY Pause the music by pressing once and a second time to continue

VIDEO The **VIDEO** button will toggle through the active video screens

PAGE 2 will switch the screen to the second page of this mode

MODE The **MODE** button will switch the radio to the next mode



Use the **UP** and **DOWN** buttons to raise and lower the volume

The **SEEK** left and right buttons will tune up and down songs.

To **MUTE** the volume press the **MUTE** button. Press again to unmute

BACK TO VIPER will return the system to the last non radio screen

MENU The **MENU** button will enter a mode to change folders

SELECT When in folder select mode select will activate selected folder and song.

PAGE 1 will switch the screen to the first page of this mode

MODE The **MODE** button will switch the radio to the next mode



Use the **UP** and **DOWN** buttons to raise and lower the volume

In normal mode the **SEEK** buttons control tuning. In **FOLDER** mode it will toggle through folders and songs.

To **MUTE** the volume press the **MUTE** button. Press again to unmute

Fosgate Video Radio Screens

The Fosgate radio with video has a menu screen that can be navigated and controlled using the Viper buttons. To use this ability, the radio video screen with button needs to be enabled in the MEDIA SETUP screen in SETUP.

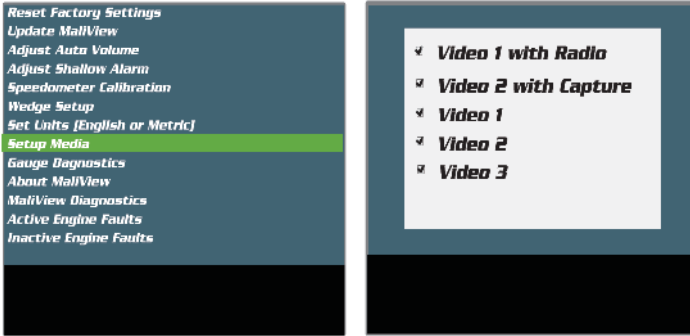

This mode will bring up buttons on the side for 5 seconds. These buttons describe what each button will do while in this screen. Make sure the radio's video output is in video input #1. Press the Video button twice to exit the screen.



Video Operation

The POV option includes the ability to start and stop a recording using the display's ENTER button. To use this ability, the video screen with capture needs to be enabled in the MEDIA SETUP screen in SETUP.



There is also a new module that will be needed to make the Viper system work with the POV. This is the POV RF module. It is connected to the system using a gauge connector located with the other gauge connections. Make sure the video output from the POV is going into the Video #2 input on the Viper.



Once the system is set up, the START/STOP REC button will appear next to the ENTER button when first entering the Video #2 screen, as well as when the Video button is pressed. While in this screen, the ENTER button will always act as the START/STOP button. Press the VIDEO button twice to leave the VIDEO CAPTURE screen.



Auto-Volume for MaliView

One of the enhancements to the software for the MaliView is the addition of auto-volume. This feature will automatically increase and decrease the volume of the stereo as boat speed increases and decreases. You can access the auto-volume feature through the MaliView Setup Screen (see page 2-6). Use the up and down arrow buttons to adjust the intensity level from 1-3, 3 being the most aggressive, or “OFF.” When you reach the desired level, press the ON/OFF/ENTER button to save changes.

MaliView Media

With the new optional MaliView you now have capabilities that range from watching videos to playing video games on the new 6.5" screen. As long as your device has the standard RCA cables as an output it will play through the stereo AUX mode and onto the screen in Video 2. We provide the left/right audio to mini adapter that came in your boat bag and the video jack is located right next to the mini/USB jack for your convenience. Simply plug the red and white RCA into the adapter and then plug that into the mini jack, then place the yellow RCA into the video jack. Now put your stereo into the AUX mode and put the MaliView onto Video 2. You can now enjoy your music videos, movies, or even a video game. Replace the audio port cover when it is not in use to help protect it.



Figure 2-48. MaliView Media



Figure 2-49. RCA Adapter

NOTICE

The glove box is not water-tight. To prevent water damage to paperwork and/or electronics, we suggest placing electronics such as cell phones and I-pods in a ziplock bag to prevent damage from rain or water over the bow.

Hot Water Shower

If your boat is equipped with a hot water shower, you will find an ON/OFF accessory switch located in the rear storage area. You will find the valves located on the starboard side of the motorbox compartment. The shower head can be found in the port gunnel sides. You should find specific instructions on the use of your hot water shower in the packet of materials you received with your boat.



Figure 2-50. Shower Head



Figure 2-51. Shower Valve

Pull-Up Cleats

Pull-Up cleats are available for all boat models. These cleats will sit flush on the side of the boat deck when depressed. To use the cleats, simply pull them up. Push the cleats down to stow them.



Figure 2-52. Pull-Up Cleat

Docking Lights

The docking lights should only be used during slow speed docking maneuvers. The lights are activated by a switch on the accessory switch panel and have a 10 amp circuit breaker. The docking lights use LED bulbs which cannot be replaced.

Boat Bumpers Quick Release

Use the boat bumpers quick release to quickly install and remove the bumpers (fenders) and ensure that they are in the correct location for protecting the boat while docking.



Figure 2-53. Boat Bumpers Quick Release

Tower

WARNING



Due to vibration and rough water conditions it is possible for bolts to loosen. Before each use, inspect all mounting bolts (Tower, Wakeboard Racks, Lights, Speakers, etc.) to ensure they are tight. See your local dealer for any questions and/or assistance. Failure to do so can cause serious damage and/or injury to the boat and/or passengers.

Properly stow the bimini top in its boot and remove all boards from the board racks prior to towing/trailer your boat. Speeds exceeding 50 MPH (80 km/h) with the bimini not properly stowed may cause damage to the bimini top. Damage to the bimini from towing while not stowed is not covered under warranty. Damaged or excessive wear to board racks caused by towing or trailering with boards attached is not covered under warranty.

The tower is rated for a maximum of 130 lbs (58.9 kg) accessory weight and not more than 600 lbs (272.1 kg) total rider weight. Exceeding these limits voids any structural warranty pertaining to the tower. Approved activities for usage of the tower include wakeboarding, wake skating, skiing or tubing.

Only factory pre-drilled holes should be used to install factory accessories on the tower. The use of aftermarket accessories not supplied by Malibu Boats may cause damage not covered by the tower warranty. Drilling any additional holes in the tower will void any structural warranty.

Appropriate care must be taken to ensure the tower is not allowed to fall.

Towers are configured from the factory with shocks based on the factory-installed components. If ANY additional components are mounted to the tower after the boat leaves the factory, it is the dealer and the consumer's obligation to validate that the installed shocks and the tower are rated for these additional components.

The board racks can be turned to the inside or outside of the boat, lowering its profile for storage. Also, the rope bracket can be folded forward toward the mast light.

Illusion G3 Tower Option

The Illusion G3 has a solid foundation of billet aluminum bases and billet tower support wings backing the 3" stainless steel hoop. The Illusion G3 features dual gas spring shocks to assist in creating the feature of weightless fold-down. The Illusion G3 tower is secured in the UP position by two latches. To raise the tower, stand with your back toward the bow of the boat. Raise the tower. Secure the tower in position with the two tower latches.



Figure 2-54. Tower Latch

WARNING

ALWAYS verify that both latches are securely locked in place before using the tower for towing. NEVER use the tower for towing without securing both latches.

To lower the tower, pull out on the top of each latch and rotate. Grab the top of the tower in front and pull down toward you.

G4 Tower Option

The G4 tower is similar in construction to the Illusion G3. To raise the tower, stand with your back toward the bow of the boat. Push the port side handle halfway in. The red portion of the handle will be hidden and the yellow portion will be visible. Raise the tower. Once the tower is fully extended, the port side handle will lock, holding the tower up. Push both handles completely in, locking the tower in place.



Figure 2-55. Starboard Side

WARNING

ALWAYS verify that both handles are securely locked in place before using the tower for towing. NEVER use the tower for towing if either color (red or yellow) is visible on the handle.

To lower the tower, pull both handles completely out with both yellow and red colors showing. Grab the top of the tower in front and pull down toward you.



Figure 2-56. Port Side

Hardware

Most of the metal hardware on your boat consists of brass, stainless steel, or aluminum and should be cleaned on a periodic basis with soap and water. In fresh water, metal fittings and hardware should be sprayed regularly with a rust inhibitor and after every use in saltwater.

DO NOT use cleaners that are not intended for use on stainless steel. Glass, tile, counter or citrus cleaners can damage hardware permanently. Always follow cleaning, by applying a high-quality metal polish or automotive wax after cleaning. Test products in an inconspicuous area before applying to the complete surface, especially if you are not familiar with the product.

All metal parts, including but not limited to tower accessories, board racks or speaker cans, should be cleaned with mild soap and water frequently and waxed periodically. A corrosion protectant is highly recommended on these components, especially for use in areas of or in proximity to salt/brackish water. Pitting, corrosion or oxidation is not covered under warranty. Pitting is not the same as separation.

Viper Chart Plotting Instructions

Map Screen

This section will attempt to familiarize the operator with the features and functions of this system. The Medallion Navigation system uses GPS (Global Positioning System) satellites, and a map database to calculate and display route directions. The GPS is based on satellites which orbit the earth and continuously emit signals. The GPS receiver located on the boat receives those signals and calculates, based on the signals, its distance from the respective satellites. This information is used to calculate your current geographic position. The signals of at least three satellites are needed to determine the current location. When entering the Navigation system, the screen below is the first screen that is displayed.

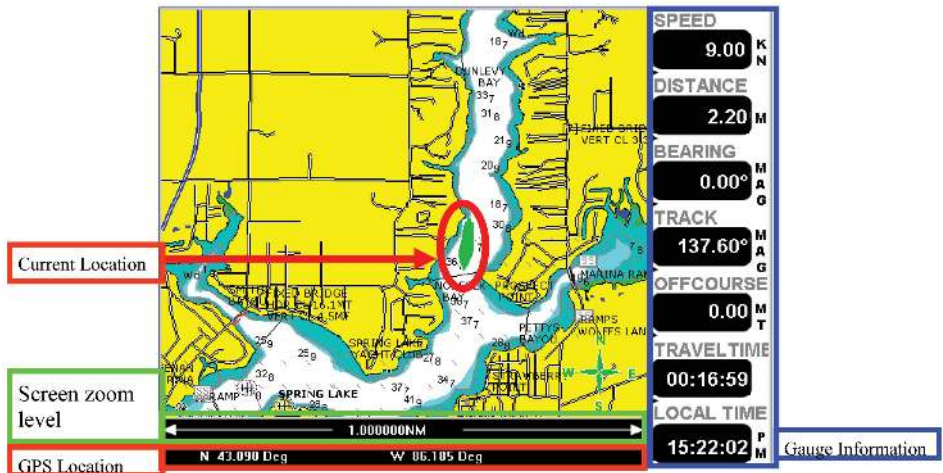

Main Map Screen

When entering the Navigation area, this is the first screen that comes up. Each section of the screen is highlighted above and described below.

CURRENT LOCATION — This image shows the current location of the boat.

ZOOM LEVEL — This bar shows the zoom distance across the screen. In the example above the distance from the left of the screen to the right of the screen is 1 nautical mile. This can be adjusted from 0.1 to 4000 nautical miles by pressing the + or – buttons.

GPS LOCATION — This area of the screen shows the coordinates from the GPS antenna. This can be configured to display 1. Degrees, 2. Degrees, Minutes, 3. Degrees, Minutes, Seconds.

GAUGE SCREEN — This area of the screen shows up to seven informational gauge screens. This gauge screen section can be turned on or off in the SETUP menu (FULL/GAUGE).

Navigation Menu

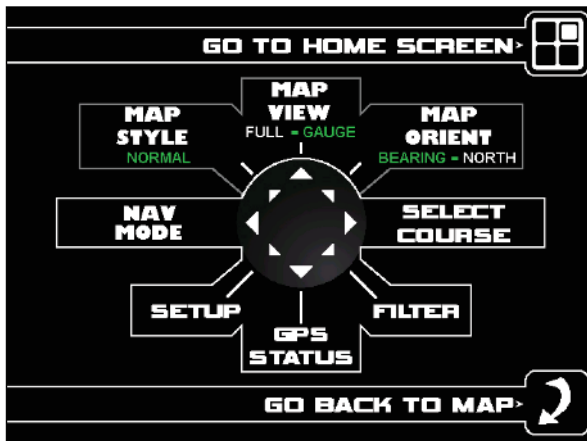

Above is the main navigation menu screen. From here the operator can get to any area of the navigation system. Pressing the ENTER button will display the MAP screen.

Map View



FULL



GAUGE

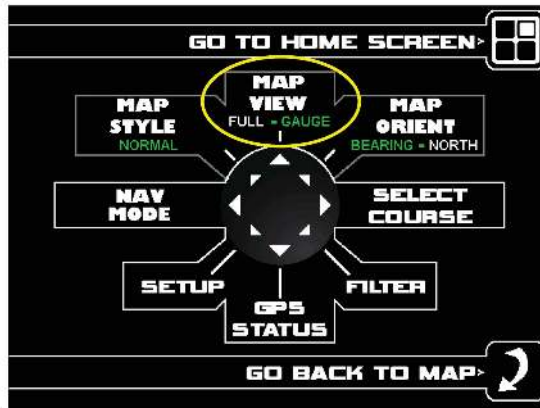

Starting at the Navigation Menu screen, the MAP screen can be adjusted to show the MAP on the entire screen or show gauge information along the right hand side of the display.

Underneath the words “MAP VIEW” are the words “FULL” and “GAUGE”. The word that is highlighted indicates how the MAP screen will be displayed.

For more information on the GAUGE screens, see the SETUP menu options.

Map Orient

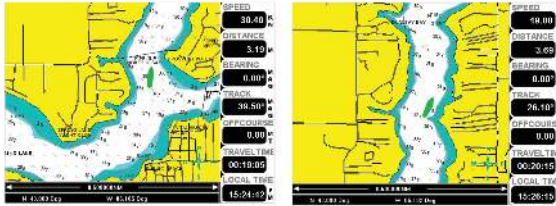

BEARING

NORTH

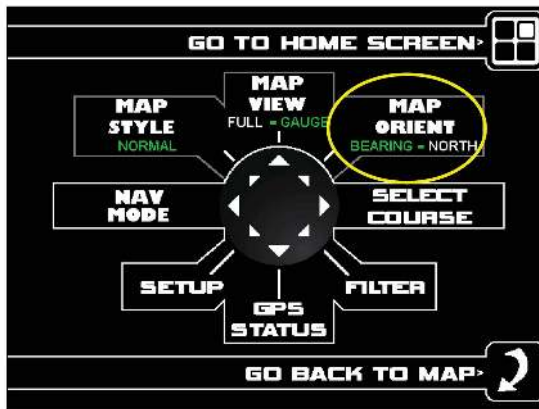

The MAP screen can be adjusted to orient the map with north always at the top of the screen, or with the boat heading at the top of the screen. Underneath the words “MAP ORIENT”, toward the top left of the screen, are the words “BEARING” and “NORTH”. The word that is highlighted indicates how the MAP screen will be oriented.

Pressing the UP/RIGHT arrow will cause the highlight to change between “BEARING” and “NORTH”. Examples of “BEARING” and “NORTH” screens are shown above. Note the compass heading in the lower right corner of the display rotates on the “BEARING” orientation.

Select Course

Creating a New Course

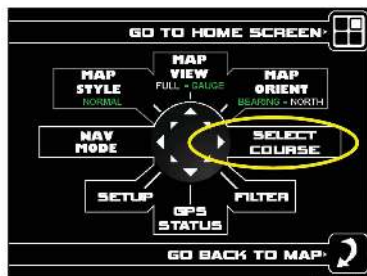

From the Navigation Menu screen press the RIGHT arrow to begin creating a course.



Use the down arrow to highlight the "NEW" option. Then press the ENTER button.

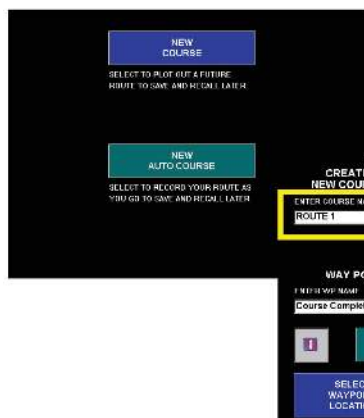

Using the arrow buttons, highlight the "NEW COURSE" and press "ENTER". A new name is not required, the generic name will be used if the following steps are skipped.

A new screen will appear, using the arrow buttons, highlight the "ENTER COURSE NAME". A keyboard will appear. Use the arrows to highlight the letter desired and press "ENTER". Once the course name is entered, highlight the "OK" and press "ENTER". The new course name will appear in that window.

Highlighting the "ENTER WP NAME" will bring up the keyboard again. A new name is not required, but is optional. The generic name will be used if these steps are skipped.

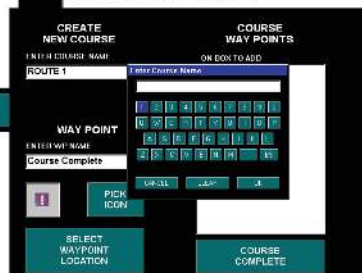

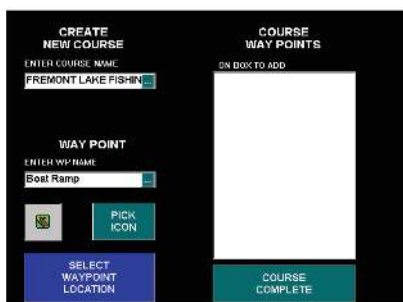

Using the arrow buttons, highlight the “SELECT WAYPOINT LOCATION”.

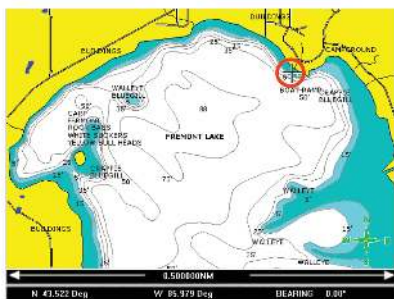

Using the arrow buttons, move the cursor (cross) to the beginning location of the desired course and press the “WAYPOINT” button .



A new window will appear showing the available waypoint options. Use the arrows to highlight the desired waypoint and press “ENTER”.

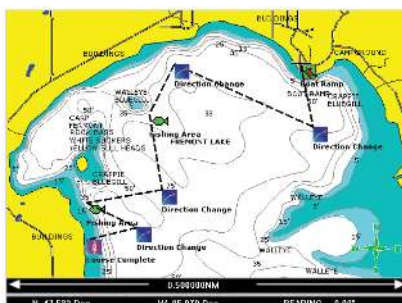

The map screen will be shown again with the waypoint in the location that the cursor was. Use the arrows to move the cursor to the next waypoint and press the “WAYPOINT” button. Repeat this for all of the waypoints desired.

NOTE: It is very important that the last waypoint be a “COURSE COMPLETE” waypoint.

Select Auto Course

Creating a New Auto Course

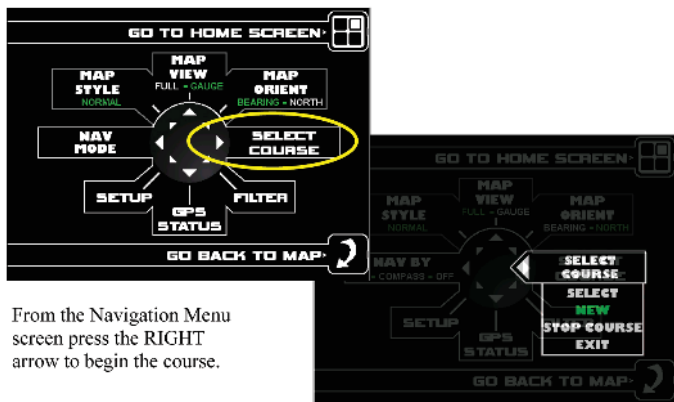

From the Navigation Menu screen press the RIGHT arrow to begin the course.

Use the down arrow to highlight the “NEW” option. Then press the ENTER button.

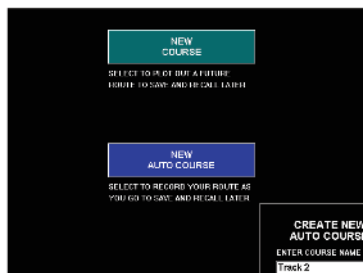

Using the arrow buttons, highlight “NEW AUTO COURSE” and press “ENTER”.

A new screen will appear, using the arrow buttons, highlight the “ENTER COURSE NAME”. A keyboard will appear, use the arrows to highlight the letter desired and press “ENTER” to select it. Once the course name is entered, highlight the “OK” and press “ENTER”.

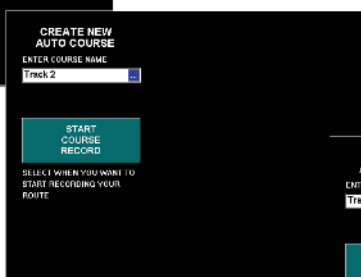

The new course name will appear in the “ENTER COURSE NAME” window. A new name is not required, but is optional. The generic name will be used if this step is skipped.

Position your boat where you would like this course to start. Highlight the “START COURSE RECORD” to begin tracking your course.



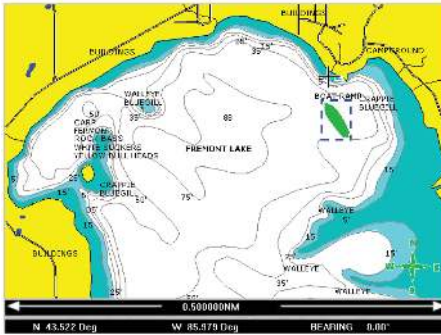

After selecting “START COURSE RECORD,” the map will appear. Your location is the boat image (in the screen to the left it is within the blue box). The navigation software will track your movements until the STOP COURSE option is selected.

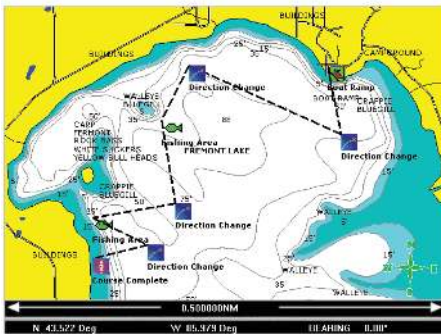

NOTE: Be sure to make the last waypoint the COURSE COMPLETE waypoint.

Filter

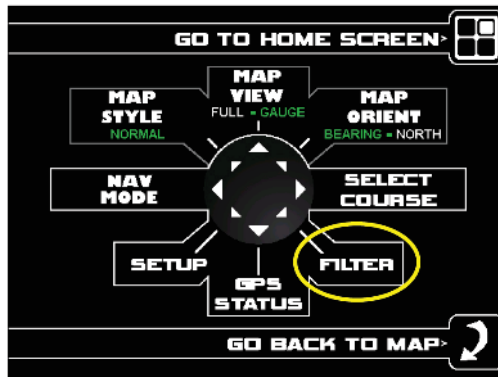

The FILTER menu allows the operator to adjust/change what is displayed throughout the various screens. From the Navigation Menu screen press the DOWN/RIGHT arrow to adjust the filters.

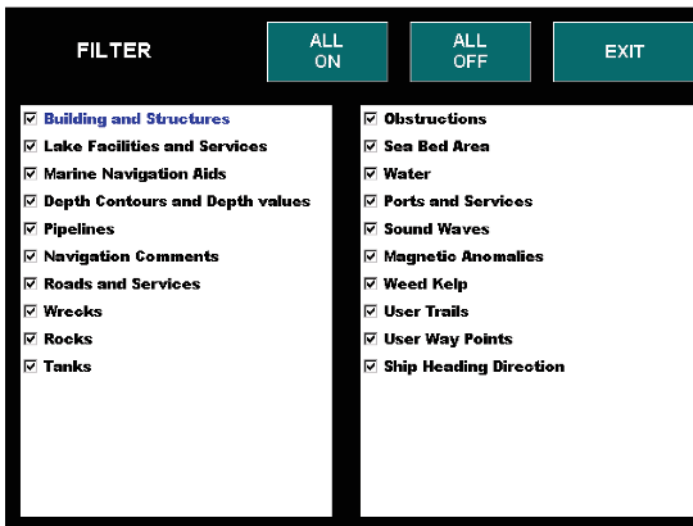

The screen above shows the objects that may be available to display. If there is an object that is not desired, remove the check box and that object will not be displayed in the map.

GPS Status

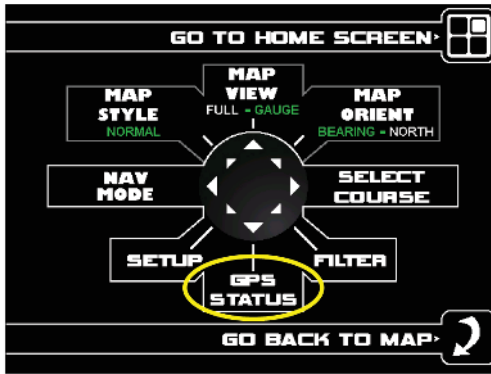

From the Navigation Menu screen press the DOWN arrow to access the GPS STATUS screen.

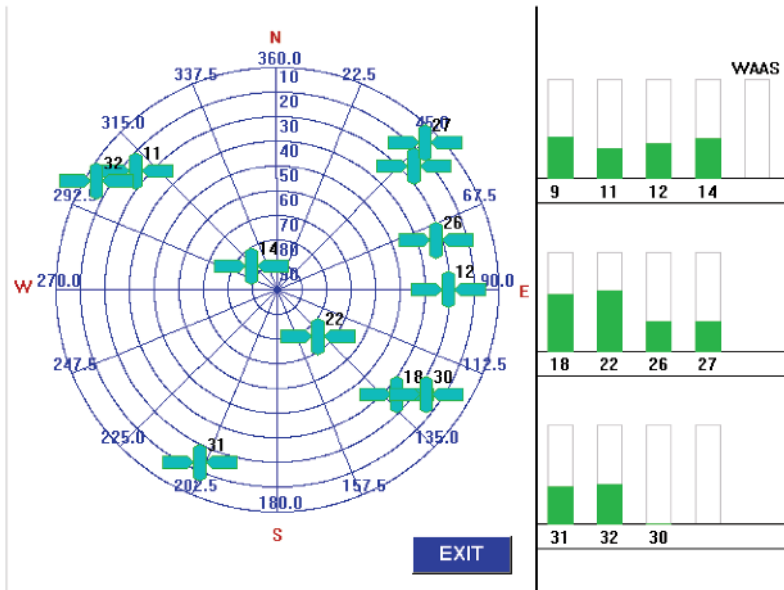

The GPS STATUS menu allows the operator to view up to a 16 position satellite signal strength graph on the right side of the display, and a 4 point compass graphic showing the relative position of each satellite on the left side of the display.

Setup

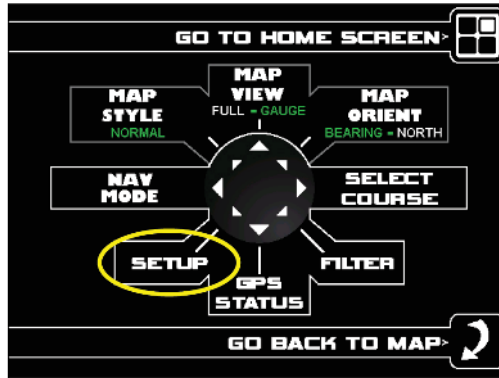

From the Navigation Menu screen press the DOWN/LEFT arrow to access the SETUP menu.

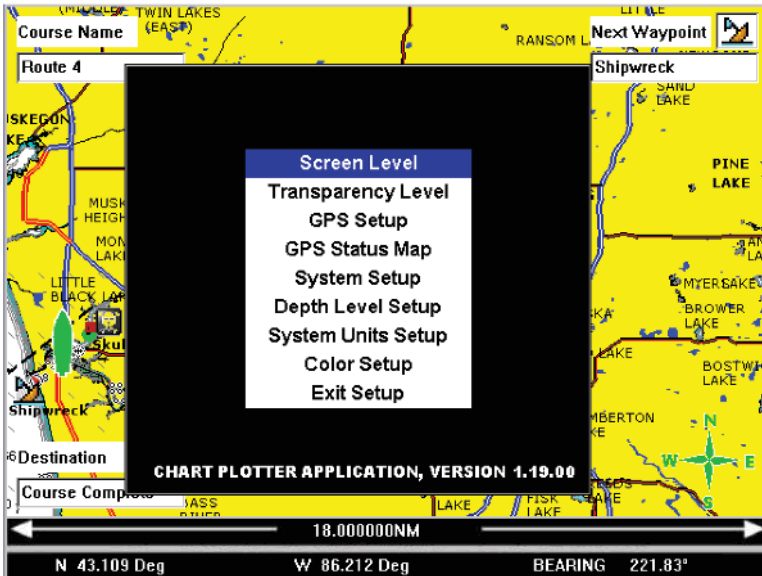

The SETUP menu allows the operator to adjust, view and configure the navigation system through eight menus.

Screen Level

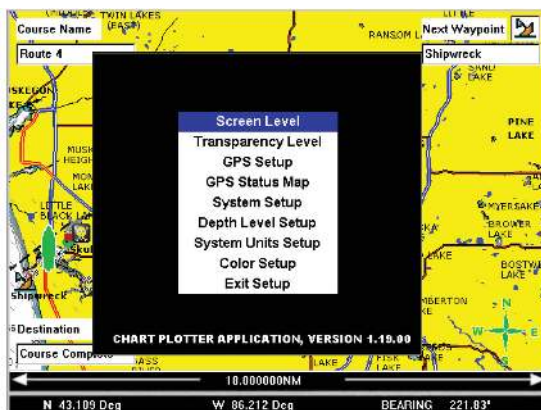

SCREEN LEVEL is the contrast adjustment menu. Highlight the SCREEN LEVEL and press the ENTER button. The screen below will appear.

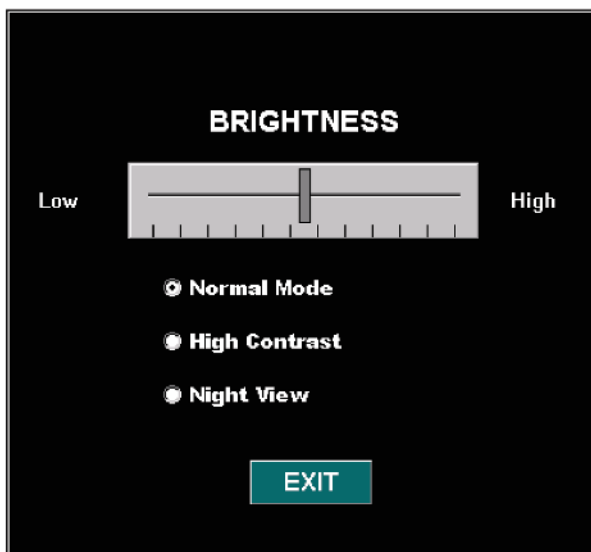

Using the arrows, UP/DOWN changes between the low/high scale, Normal Mode, High Contrast, and Night View. The LEFT/RIGHT arrows control the slide on the Low to High brightness scale. Highlighting the EXIT and pressing ENTER will bring the display back to the MENU screen.

Transparency Level

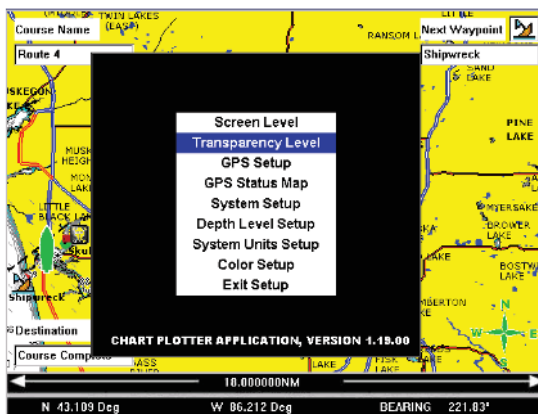

TRANSPARENCY LEVEL can be set to enable the user to see the map while viewing the menus. Highlight the TRANSPARENCY LEVEL and press the ENTER button. The screen below will appear.

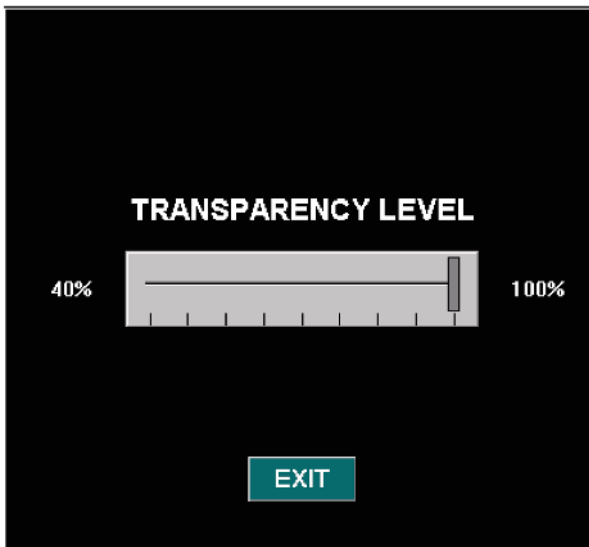

Using the arrows, UP/DOWN changes between the transparency scale and the EXIT. The LEFT/RIGHT arrows control the slide on the transparency scale. Highlighting the EXIT button and pressing ENTER will bring the display back to the MENU screen.

GPS Setup

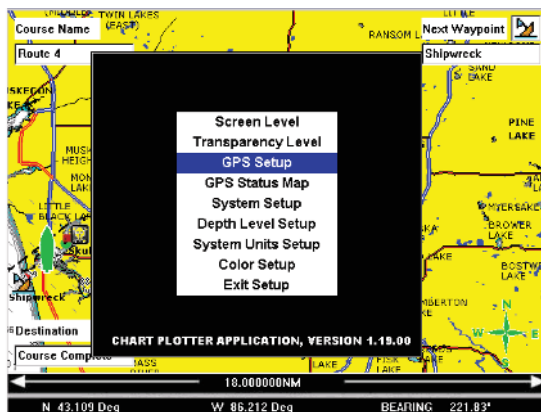

GPS SETUP can be set to enable what data and accuracy the user wants to see on the map while operating the menu features. Highlight the GPS SETUP and press the ENTER button. The screen below will appear.

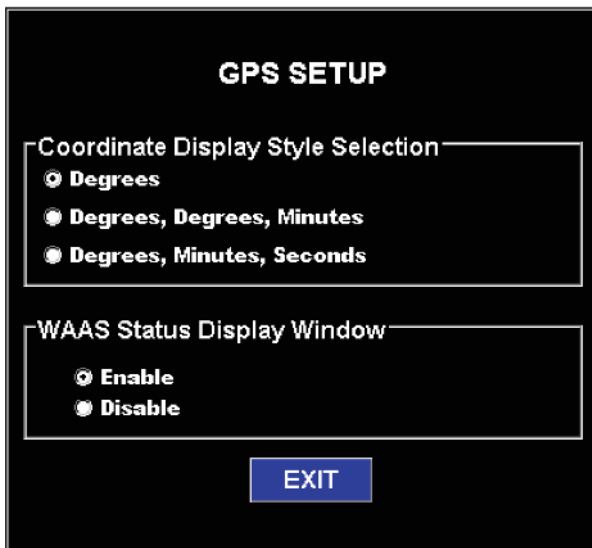

Using the arrows, UP/DOWN changes between the Coordinate styles and WAAS status options. Highlighting the EXIT button and pressing ENTER will bring the display back to the MENU screen.

GPS Status Map

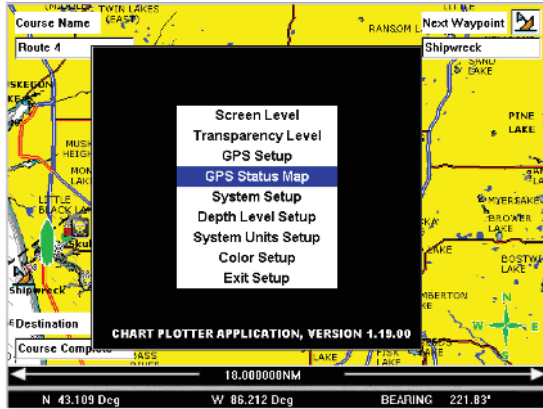

GPS STATUS MAP will display the satellite signal strength. Highlight the GPS STATUS MAP and press the ENTER button. The screen below will appear.

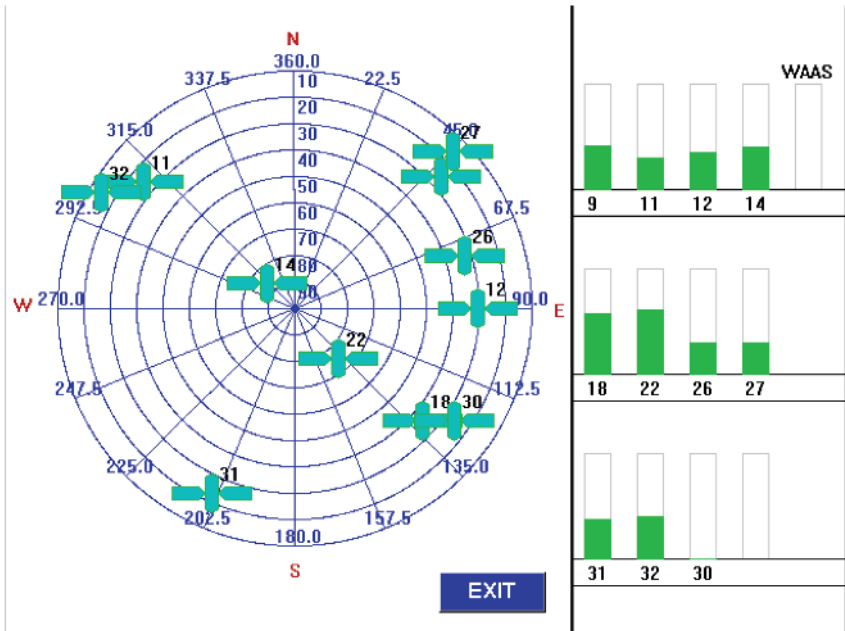

The GPS STATUS menu allows the operator to view up to a 16 position satellite signal strength graph on the right side of the display, and a 4 point compass graphic showing the relative position of each satellite on the left side of the display.

System Gauge Setup

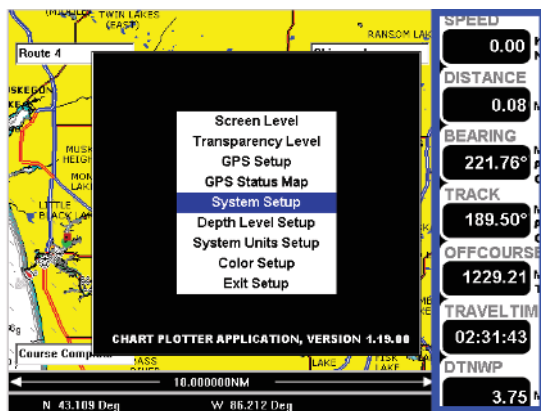

SYSTEM SETUP will display the gauge options that can be shown when the gauge information is displayed on the right side of the screen. Highlight the SYSTEM SETUP and press the ENTER button. The screen below will appear.

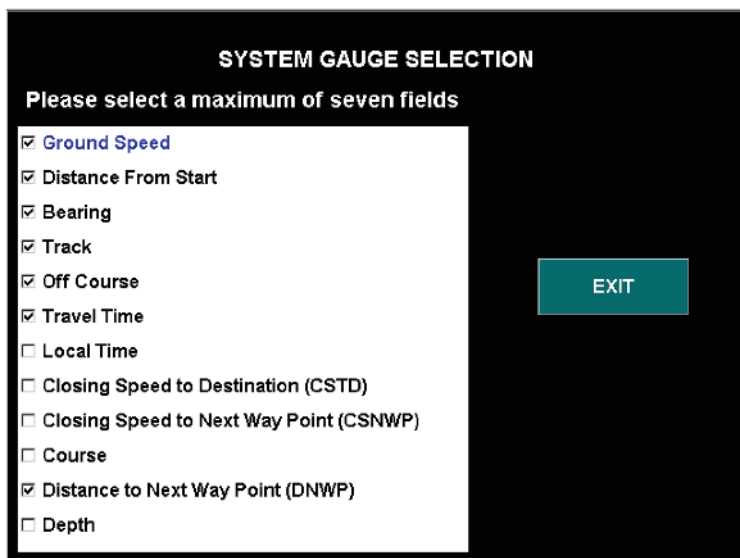

Any of the options listed above can be displayed in the gauge area of the MAP screen. Only seven items can be selected to be displayed at one time. Highlighting the EXIT button and pressing ENTER will bring the display back to the MENU screen.

Depth Level Setup

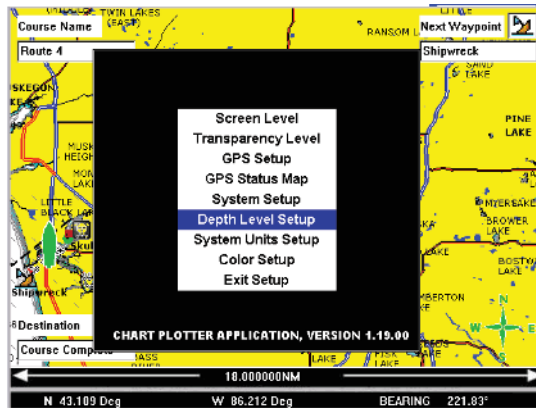

DEPTH LEVEL SETUP will display the options for how to draw the mapped depth contours of the various waterways. Highlight the DEPTH LEVEL SETUP and press the ENTER button. The screen below will appear.

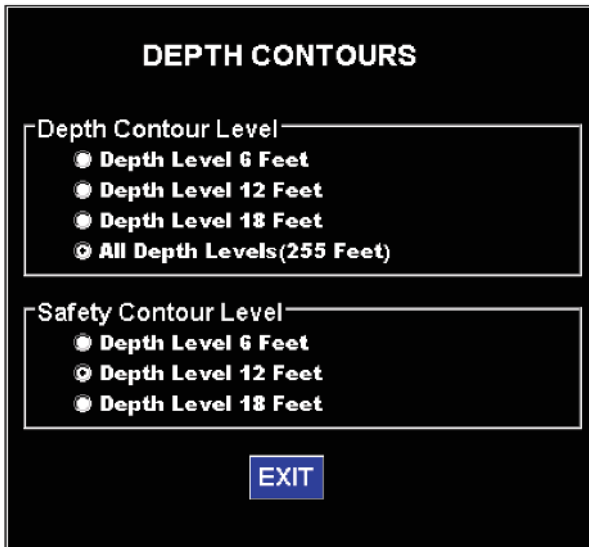

The options listed above will change how the waterways are to be displayed on the MAP screen. Depending on which setting is chosen will enable how much detail is drawn into each waterway. Highlighting the EXIT button and pressing ENTER will bring the display back to the MENU screen.

System Units Setup

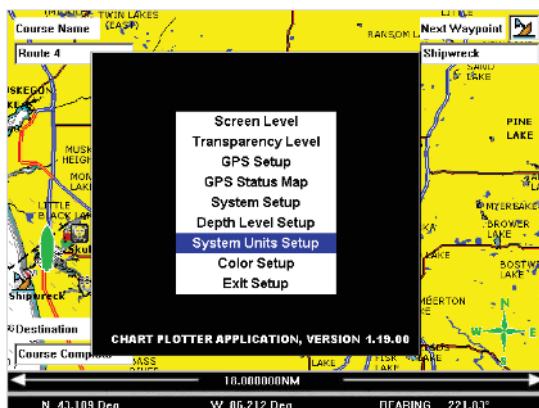

SYSTEM UNITS SETUP will enable the operator to change speed units between Knots and Miles Per Hour. This menu also allows the operator to change distance units between Nautical Miles and Miles. Highlight the SYSTEM UNITS SETUP and press the ENTER button. The screen below will appear.

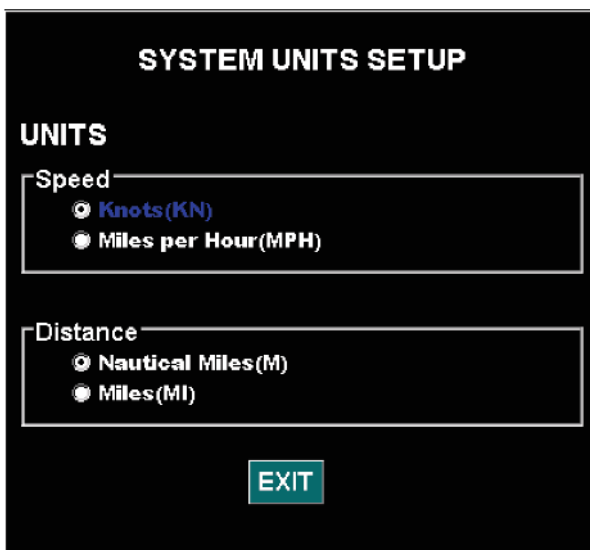

The options listed above will change how the speed and distance are to be displayed on the MAP screen. Depending on which setting is chosen will enable the appropriate units. Highlighting the EXIT button and pressing ENTER will bring the display back to the MENU screen.

Color Setup

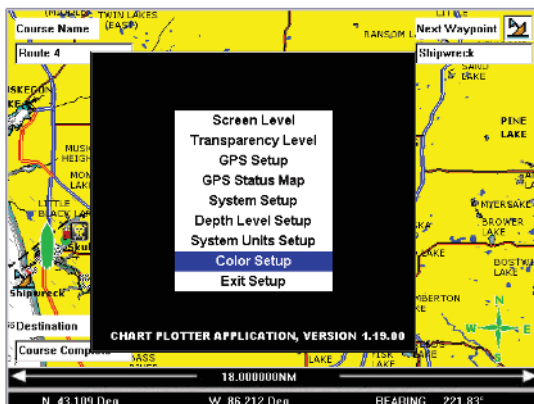

COLOR SETUP will enable the operator to change the color settings on most menu options. Highlight the COLOR SETUP and press the ENTER button. The screen below will appear.

COLOR SETUP		SET DEFAULT COLORS	EXIT
Window and Button Color Settings			
Window Background	BLACK		
Display Text	WHITE		
Normal Button	DARKGREEN		
Selected Button	BLUE		
Ship and Chart Color Settings			
Ship & Compass Icons	GREEN		
Ship Heading Line	GREEN		
Track & Route lines	BLACK		
Cross Hair Cursor	BLACK		
Chart Land Area	YELLOW		
Chart Water Area	WHITE		
Chart Area Details	BLACK		
Depth Values	BLACK		

The options listed above will change the color of that feature that is to be displayed on each screen. Highlight the desired option and press ENTER. This will display a dropdown box with the color options available. Highlighting the EXIT button and pressing ENTER will bring the display back to the MENU screen.

Exit Setup

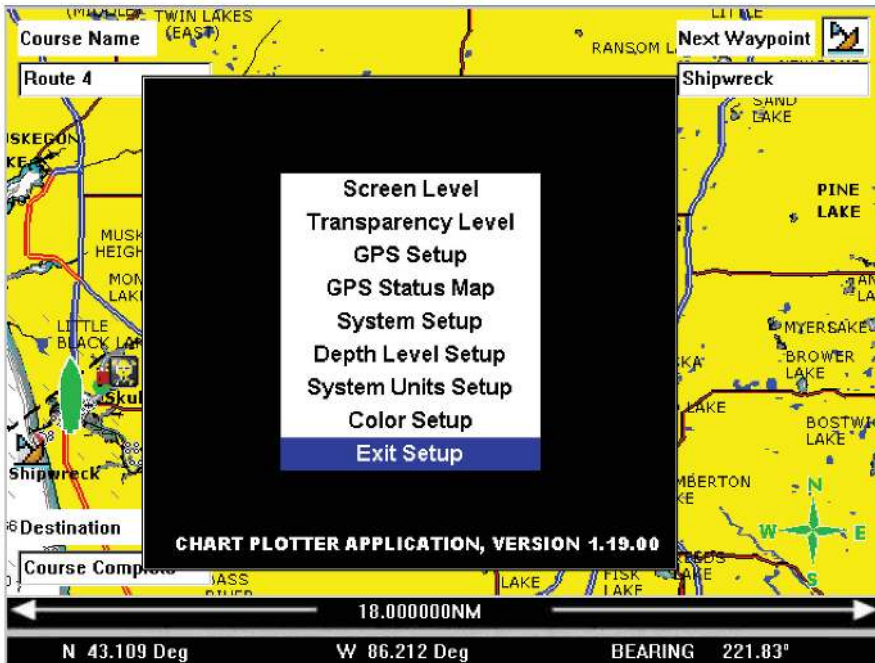

Highlighting the EXIT SETUP and pressing ENTER will bring the display back to the MENU screen.

NAV BY

Map—Compass—OFF



From the Navigation Menu screen press the LEFT arrow to change the way the system navigates. There are three modes of navigation: MAP, COMPASS and OFF.

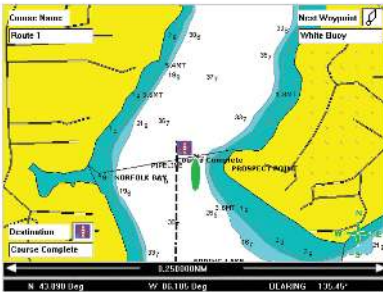

MAP mode shows the Course name, Next Waypoint and Destination.

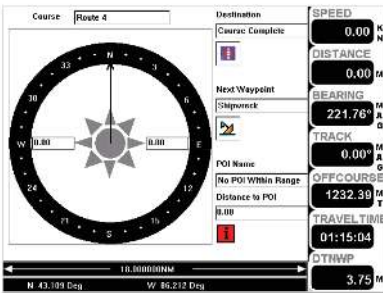

COMPASS mode shows the compass rotating with the heading always at the top of the screen. This option also shows the Course name, Next Waypoint, Destination and distance to (POI) Point Of Interest along with the seven gauge screens (if selected).



OFF mode clears the Course name, Next Waypoint and Destination from the display.

Compass



From the Navigation Menu screen press the LEFT arrow to change the highlight to COMPASS. This will change the top three options in the menu to the screen below.



POI NOTIFY (ON/OFF) — Indicates when you are near a Point Of Interest on the map.

TRACK TRAIL (ON/OFF) — Will leave a trail in the direction of where your last waypoint was.

ADJUST NOTIFY BAND — Pressing the UP/RIGHT arrow brings up a box that allows the setting of the notify distance to the next POI.

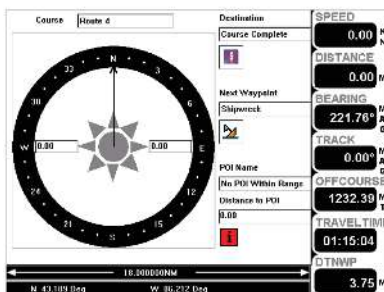

When “NAV BY” is set to COMPASS mode, the MAP screen will show the image to the left which shows the compass rotating with the heading always at the top of the screen. This option also shows the Course name, Next Waypoint, Destination and distance to (POI) Point Of Interest.

Wedge

The Malibu Manual Wedge foil is a solid, one piece, welded design constructed from solid stainless steel. The wedge foil no longer locks in the down position. It is designed to move up or down freely and locate in the down position.

To lower wedge unit, depress spring loaded pins and lower foil. Be sure to raise and lock foil in the up position each time after use.

If your boat is equipped with the Wedge option, you will find that the unit has two positions - DOWN or UP. To adjust wedge position, access wedge through the swim platform door.



Figure 2-57. Wedge Down



Figure 2-58. Wedge Up

WARNING



When wedge is up, ensure both spring loaded pins are engaged before taking off. DO NOT adjust manual wedge while engine is on or boat is moving.

WARNING



Excessive speeds over 25 MPH could cause adverse handling conditions. It is recommended that you put the Wedge unit in the UP position if you will be traveling over these speeds.

Optional Malibu Launch System (MLS)

The Malibu Launch System (MLS) ballast system allows water to be stored on board to increase hull weight for larger wakeboard wakes. Depending on model the MLS can be available as front, center or rear ballast tanks. If your boat is equipped with this feature, locate the MLS switches on the dash accessory panel to fill or drain the ballast tanks; press switch up to fill, or down to drain.

Chapter 3

OPERATION



Everyone benefits from the safety of others.

Trailer

The trailering information contained in this section describes general guidelines and procedures used by many boaters. We recommend, in addition, that you always follow the specific information provided by the manufacturer of your trailer.

NOTICE *Your trailer is not manufactured by Malibu. For specific trailer information, refer to the trailer's owner's manual in the information packet shipped with your boat.*

Load Carrying Capacity

The certification label attached by the manufacturer on the left forward side of the trailer will show the maximum load carrying capacity of the trailer. The label is required to show the Gross Vehicle Weight Rating (GVWR), which is the load carrying capacity plus the weight of the trailer itself. Be sure that the total weight of your boat, gear and trailer does not exceed the GVWR. Verify tire pressure for load capacity.

NOTICE *Consult your trailer dealer for other state regulations concerning brakes, lighting and other equipment options.*

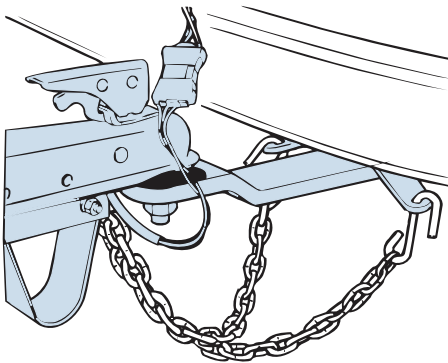

Figure 3-1. Trailer Hitch

KC-1700

Hitch

Hitches are divided into classes that specify the gross trailer weight (GTW) and maximum tongue weight for each class. Always use a hitch with the same class number as the trailer, or greater. Most boat trailers connect to a ball hitch that is bolted or welded to the towing vehicle. Clamp-on bumper hitches are not recommended.

The trailer hitch coupler must match the size of the hitch ball. Never use a hitch ball that does not match the trailer coupler. The correct ball diameter is marked on the trailer coupler.

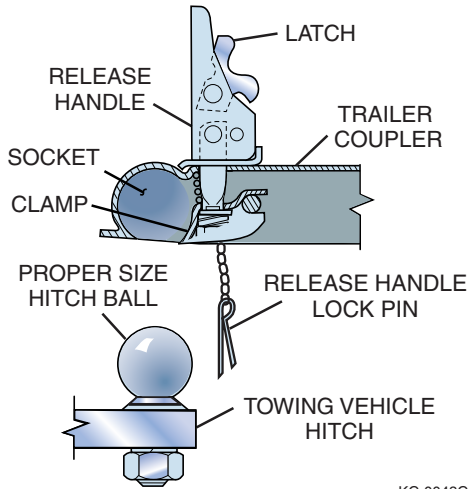

KC-0043C-A

Safety Chains

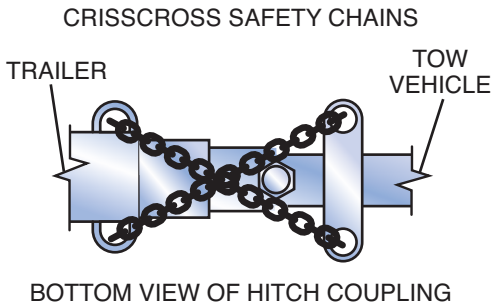

KC-0045C-B

Safety chains on your boat trailer provide added insurance that it will not become completely detached from the towing vehicle when underway.

Crisscross the chains under the trailer tongue to prevent the tongue from dropping to the road if the trailer separates from the hitch ball. Rig the chains as tight as possible with just enough slack to permit tight turns.

Make sure the proper chains are correctly attached between the towing vehicle and trailer before and during each trip.

Figure 3-2. Safety Chains

Tie-Downs

Making sure your boat is held securely in place on the trailer hull supports is extremely important, especially when underway. Regardless of your trailer make or model, there are two key areas to consider:

- **Bow Tie-Downs:** A bow stop to hold the front of your boat in place is located on the winch stand. It should be positioned so that the winch line pulls straight and is parallel to the trailer frame. A separate tie-down should then be attached to hold the boat downward and forward. This may be accomplished by a line from the bow eye to an attachment point on the trailer frame or winch stand.

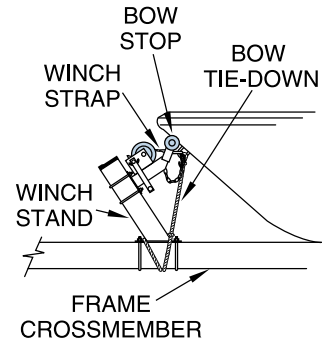

Figure 3-3. Bow Tie-Down

- **Rear Tie-Downs:** It is very important to be sure the transom of your boat is resting fully and securely on the supports provided at the rear of the trailer, and that it remains in place when parked or underway. Special rear tie-downs are available for this purpose. Check often to be sure the rear tie-downs are securely locked in place and tight enough to prevent any movement of the boat.



Figure 3-4. Transom Tie-Down

Backing the Trailer

Backing the boat trailer may sometimes be a difficult task. It is recommended that you practice backing the trailer in a vacant lot or open area before attempting it at a congested boat launch.

Follow these basic rules when backing:

- 1) Turn the front vehicle wheels in the opposite direction in which the trailer is to travel.
- 2) Back vehicle normally once the trailer turn is started.
- 3) Have your vehicle equipped with a right hand mirror, as required by law when towing.

Launching

Following are some helpful tips to assist you with launching your boat:

- Before launching, check the type and condition of the ramp. Ramps are usually made of cement but often times are made of asphalt or even sand. When wet, these ramps can get very slick and can cause additional difficulties when launching your boat.
- Have someone assist you when backing your boat. Back the trailer to the edge of the water and stop. Be sure to properly secure your vehicle.
- Prepare for placing the boat in the water by removing any tie-down straps, disconnecting tail light connections, and attaching a line to the bow eye fitting. If you are using an outboard, be sure that the outboard unit is trimmed up. Be sure to reinstall the bilge drain plug if it has been removed.
- To launch, back the trailer into the water to a point where the boat will clear the bottom. Stop and secure the vehicle.
- Unlock the winch line from the boat. Push the boat into the water and have your assistant guide the boat with the bow line.
- Once the boat is cleared of the trailer, pull your vehicle out of the water and park it.

Reloading Procedures

To reload, repeat the unloading procedures in reverse. Other important tips to remember are:

- Try to idle coast onto the trailer; do not power onto the trailer.
- When pulling the boat onto the trailer, be sure the boat is centered as much as possible. The distance between the boat and runner board should be approximately equal on both sides.
- Make sure the boat is securely in place before moving the trailer.

Load Capacity

The U.S. Coast Guard and most maritime authorities require that boats under 20 ft have a certification or builder's plate stating the number of persons and maximum weight a boat will handle safely under normal conditions. Weather conditions and other factors can adversely affect the performance of the boat and must be taken into consideration when loading to avoid an unsafe condition. The certification is attached near the helm forward of the throttle. Overloading is a violation. Do not carry more weight or passengers than indicated on the plate. The presence of the plate does not relieve the owner/operator from responsibility for using common sense and sound judgment.

Occupants must ensure that ALL weight in the boat is evenly distributed to prevent unsafe operation. Care must be taken to ALWAYS avoid creating a "bow heavy" or any other unsafe condition. If in doubt contact an authorized Malibu service center. Do not allow anyone to sit on the back of the boat, swim platform, side of the boat or any other non-approved seating area while the engine is running or the boat is in motion.

CAUTION



Never exceed the load capacity and distribute weight evenly between bow and stern, and port to starboard.

CAUTION



SWAMPING HAZARD

Overloading may reduce the stability and seaworthiness of the boat.

- The weight of all persons and gear including non-factory fitted ballast bags, water bladders, ballast tanks and fat sacks should never exceed the maximum weight capacity listed on the capacity label specified by the U.S. Coast Guard or your local maritime authority.
- Add the weight of water contained in non-factory installed ballast bags or tanks to the weight of the persons and gear. When determining total weight on board, calculate the weight of water at 9 lbs/gal (1.1 kg/L).

Malibu Boats reminds you that when your boat is fully loaded with the maximum number of persons and gear as indicated on the capacity plate, boat speed and performance will be affected. Operate a boat in this condition with extra care.

Malibu Boats designs and engineers our boats to have the best possible performance at sea level with factory-installed equipment. For this reason, it is likely your boat can be equipped or loaded in a way that can restrict its performance when operated at higher elevations. Not all available options may be able to be utilized under these conditions. Consult your dealer for more information.

Fueling

It is very important to take special precautions to avoid spillage while fueling your boat. Gasoline vapors are heavier than air and will develop in the lower cavities of the boat, such as the bilge.

NOTICE *Do not allow the fuel tank to empty completely during operation. Doing so may damage the fuel pump. Damage from running fuel systems empty is not be covered under standard warranty.*

Below is a list of guidelines you should follow when fueling your boat:

- 1) Extinguish all cigarettes and other flame or spark producing items.
- 2) Make sure all power is off, and do not operate any electrical switches.
- 3) Be sure to wipe off any spillage that may have occurred.
- 4) Operate the bilge blower for a minimum of four minutes before starting the engine.

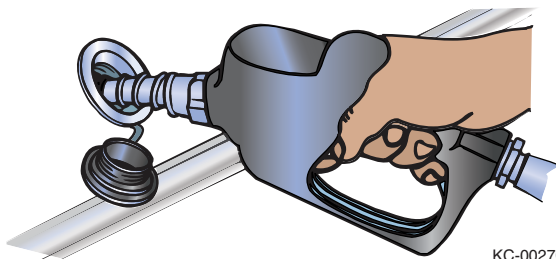

KC-0027C-A

Figure 3-5. Fueling

CAUTION *Do not overfill fuel tank. The fuel tank will expand and contract based on weather conditions, and can cause fuel to spill out the fuel exhaust vent. Damaged caused to your boat from leaking fuel due to overfilling is not covered by your warranty.*



Green Fuel System Integration

Due to a federal mandate from the EPA to reduce hydrocarbon emissions, Malibu Boats, in cooperation with Attwood and Moeller Marine, has developed a new integrated fuel tank system that dramatically reduces hydrocarbon emissions from our product. This new Green fuel system is EPA-compliant to 2012 standards and is compliant with proposed 2014 CARB phase 2 proposals.

EPA Regulations beginning July 31, 2011:

- Low Permeation fuel tanks (barrier coat inside tank)
- Diurnal Emissions controls (carbon canister)
- Customer must reasonably expect that no fuel will spill or spit back during a refueling event.
- Automatic Fuel Shutoff compatibility (Automotive style)
- Audible Click, Hinged fuel cap
- Vent system operational at all angles with full tank of fuel

Diurnal Emissions Control System Key Components:

- Deck Fill
- Inlet control valve between deck fill and tank
- Fuel Level Vent Valve on tank
- Two Grade valves on each end of tank
- Carbon Canister – mounted on port side rear seat lean back
- Waterproof fuel vent

The new Attwood fuel system is designed to automatically shut off the nozzle during refueling at a predetermined fuel level. This new predetermined level is approximately 1-1/4" lower than the top of the tank. This 1-1/4" air gap is called the ullage. The typical ullage is 7% of the tank's normal capacity.

Do not try to overfill the fuel tank. Once auto shutoff is achieved, do not try to continue filling, as this can cause unintended environmental issues.

See *Fuel System* in Chapter 4 for care and maintenance information.

Starting

First Start-Up of the Day

On the first start-up of the day, you may find it beneficial to “key up” once or twice to prime the fuel system prior to cranking the engine to start. The fuel system pressure will drop after a few hours of non-use. To prevent long crank times when starting for the first time, turn the key ON once to prime the fuel system.

This is a “High Pressure” fuel system. If you ever smell a strong fuel odor, shut down immediately and inspect for leaks.

NOTICE *The PIT fuel system is not to be serviced by anyone other than a Malibu Factory Trained and Certified Technician. Special tools and training are required to service this fuel system.*

Pay close attention to the information regarding the break-in period listed in your engine owner’s manual. Top engine performance is dependent upon following the guidelines listed.

Pre-Start Checklist

A routine pre-starting procedure should always be carried out before the first start-up of the day. Below is a list of basic, necessary checks to perform before starting your engine.

- 1) Replace drain plugs.
- 2) Check oil and transmission fluid levels.
- 3) Check fuel supply.
- 4) Inspect the engine compartment for water or fuel leaks.
- 5) Operate bilge pump until bilge is dry.
- 6) Operate blower for a minimum of four minutes to expel fumes.

Starting the Engine

Malibu boats are equipped with sensors that constantly monitor various functions of the boat. Certain functions, if outside of pre-determined operating parameters, may activate an alarm located under the dash. When the ignition is turned ON, the alarm will sound to indicate it is operating. Once the engine is running, the alarm should be off unless a problem is detected. If the alarm sounds during operation, stop the boat as soon as possible and turn off the engine. Investigate and correct the problem before returning to operation. Pressing the ENTER button on the display will silence the alarm for five minutes. Following is a list of monitored functions that can activate the alarm:

Engine Oil Alarm:

Oil pressure is less than 5 psi @ idle.

Oil pressure is less than 24 psi @ 4000 RPM.

Engine Temperature Alarm:

Engine coolant exceeds 200°F. Alarm will reset when engine cools.

Exhaust Manifold Temperature Alarm:

Water temperature exceeds 220°F.

Water Depth Alarm:

Water is shallower than water depth alarm setting.

Refer to Section 4, *Care and Maintenance, Electrical*, for more information on the alarm. Please refer to your engine owner's manual for the proper starting procedures.

Shifting/Running

The throttle lever is located to the right of the driver. When the throttle is vertical, it is in the “NEUTRAL” position.

Located at the base of the throttle you will find the shift lock knob. Pulling outward on this knob disengages the transmission, thereby allowing use of the throttle without engaging the transmission. This is used for warm-up of the engine in neutral. Be sure to position the throttle vertically (in neutral) before re-engaging the transmission by depressing the knob.

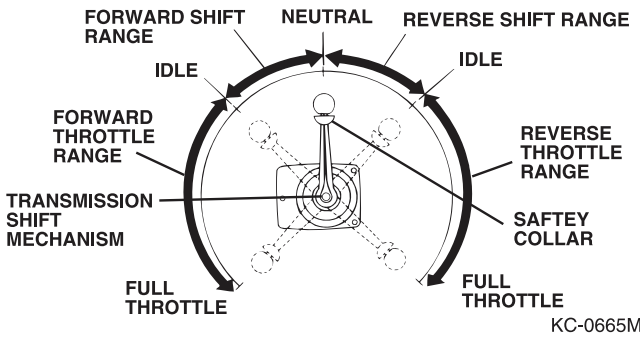

Figure 3-6. Throttle Positions

When engaging the transmission from neutral to either forward or reverse, you must pull up on the safety collar located directly below the throttle lever knob.

NOTICE *For more information regarding the safe operation and maintenance of the throttle control, refer to the separate instructions located in the information packet shipped with your boat.*

Steering

It is important that you get the “feel” of your boat’s steering system. Turn the wheel from full left to full right, and make sure the rudder is turning accordingly. The system should operate freely and smoothly.

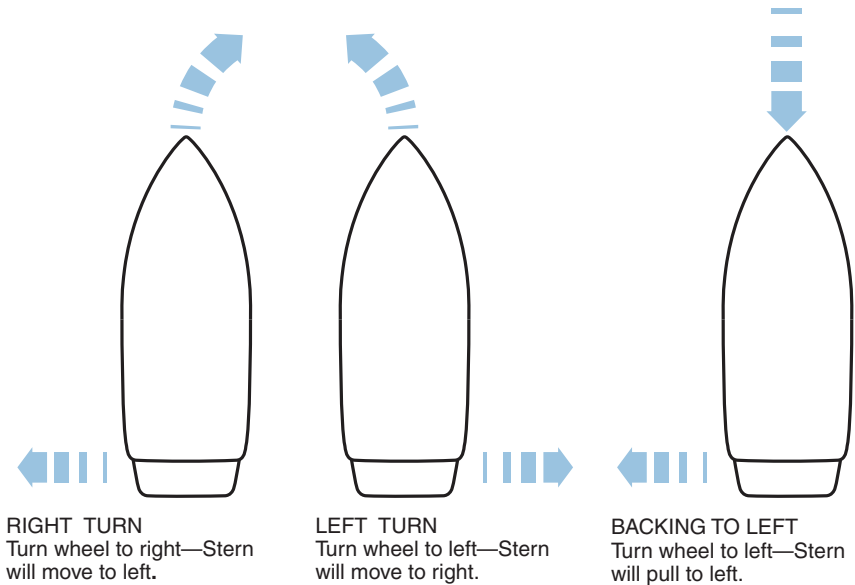

KC-0199-A

Figure 3-7. Turning with a Rudder

WARNING



The steering system must be in good operating condition for safe boat operation. Frequent inspection, lubrication, and adjustment by your dealer is recommended.

All boats have a tendency to wander somewhat at slow speeds. A natural reaction to this effect is to steer the boat back and forth in an attempt to compensate for wandering. Invariably, the compensation will result in oversteer and only worsen the effect. Keep the steering wheel in the center position, the boat will wander back and forth somewhat, but the overall course will be a straight one.

Maneuvering Techniques

Steering response depends on three factors: engine position, motion and throttle.

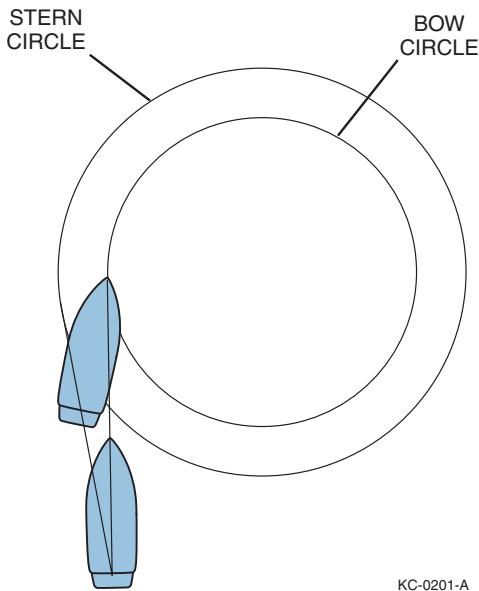

Figure 3-8. Stern Push

tends to cause the stern of the boat, steering in the straight ahead position, to drift to port when going forward, and to starboard when going backward. At high speed, this effect is usually unnoticed, but at slow speed; especially during backing, it can be powerful. For this reason, many veteran boaters approach the dock with the starboard side of the boat toward the dock, if possible, since the stern of the boat will drift starboard when reverse thrust is applied.

Like an automobile, high speed maneuvering is relatively easy and takes little practice to learn. Slow speed maneuvering, on the other hand, is far more difficult and requires time and practice to master.

When making tight maneuvers, it is important to understand the effects of turning. Since both thrust and steering are at the stern of the boat, the stern will push away from the direction of the turn. The bow follows a smaller turning circle than the stern.

The effects of unequal propeller thrust, wind, and current must also be kept in mind. While wind and current may not always be present, an experienced boater will use them to his advantage. Unequal thrust is an aspect shared by all single engine propeller-driven watercraft. A counterclockwise rotation propeller

NOTICE *Damage to boat and its underwater components caused by shallow water maneuvering is not covered by the Malibu boat warranty.*

Stopping

When stopping the boat, it is important to remember there are no brakes to allow coming to a complete, immediate stop. To stop your boat, anticipate ahead of time and begin slowing down by pulling back on the throttle.

Once the throttle is in neutral and the engine has stopped pulling the boat forward, it may be necessary to pull the throttle into reverse to further slow the forward momentum of the boat. The reverse thrust of the engine will decrease the forward speed and slow the boat down to a safer maneuvering speed. Never shift the transmission into reverse if the boat is moving faster than 2 MPH (3.2 km/h).

WARNING



Do not use the engine stop switch for normal shut down. Doing so may impair your ability to restart the engine quickly or may create a hazardous swamping condition.

Docking

Docking procedures for the new boat owner usually bring surprising results. Remember, operate your boat at slow speeds to avoid accidents and practice docking to gain experience and confidence.

Once away from the dock, practice docking in open water with an imaginary dock. Pull up to the dock at a slow rate of speed. Shift the boat into neutral and drift slowly toward the dock. Shift the boat into reverse slightly to slow or stop the boat altogether.

WARNING



Never use your hand, arm or other part of your body between the dock and boat or attempt to keep the boat from hitting the dock. The boat could push against the dock, causing severe injury.

Follow these guidelines when docking:

- Approach docks with the starboard side of the boat if possible.
 - Come to a stop a short distance from the dock, then proceed slowly.
 - Have fenders, mooring lines and crew ready.
 - Observe how the wind and current are moving your boat. Approach the dock with the boat pointed into the wind, if possible. If the wind or current is pushing you away from the dock, use a sharper angle of approach. If you must approach the dock downwind or down current, use a slow speed and shallow angle. Be ready to reverse to stop and maintain position.
 - If there is no wind or current, approach the dock at a 10 to 20 degree angle.
 - If possible, throw a line to a person on the dock and have that person secure a bow line.
 - With the bow secure, swing the stern in with the engine, or pull it in with a boat hook.
-

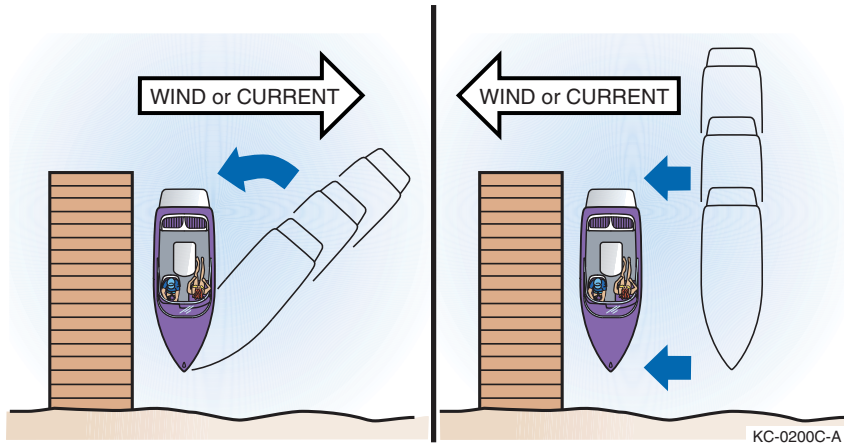

Figure 3-9. Docking with Wind/Current

Before tying up the boat, be sure to use enough fenders to protect the boat from damage. If possible, tie up with the bow toward the waves with a good-quality, double-braided nylon line. Tie up only to the lifting or tie-down eyes; never use the handrails or windshield frames. If the boat is to be moored for a long period of time, use chafing protectors on lines to protect the gelcoat finish. Leave a little slack in the lines to allow for some wave movement or tidal action if applicable.

The foredeck handrails should only be used for tying a “Jackline” in an emergency situation. If possible, tie up your boat with the bow toward the waves and leave a little slack in the lines to allow for movement from waves or the tide.

Follow these guidelines when departing:

- Very slowly shift into forward at idle speed.
- When the stern moves away from the dock, turn away from the dock.
- Cast off bow line and back away.

If the wind or current is pushing away from the dock, cast off all lines and allow to drift until you are clear.

High-Speed Operation

A great deal of caution must be exercised when operating any boat at high speeds. This is particularly true during turns. Gradual turns can be completed at high speed by a competent driver, but it must be emphasized that sudden turns at any speed, particularly at high speed can be especially dangerous. It is possible to throw passengers from their seats and even from the boat if caution is not exercised.

Towing Another Boat

Towing is normally a last resort because damage can be created by stress from the towing lines or uncontrollability of the boat being towed. Only when ideal conditions arise — lake is calm, the disabled boat is smaller than yours, and both boat operators know correct technique — should a recreational boat be towed by another.

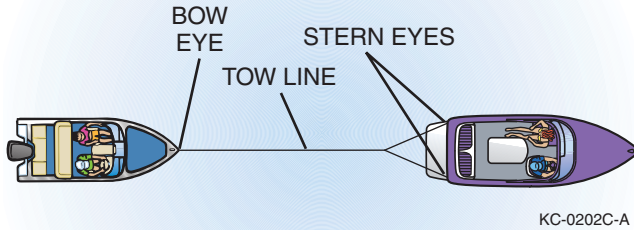

Figure 3-10. Towing

Because the towing boat is the maneuverable boat and the grounded boat is not, you should pass the tow line to the grounded boat. Use double-braided line. Never use three strand twisted nylon; it has too much elasticity and can snap back dangerously. Fasten the towline as far forward as possible on the upwind or up current side of the boat being towed. Fastening it to the stern will restrict maneuverability. Attach the line to the stern lifting eyes of the towing boat. Keep lines free of propellers on both boats. Keep hands and feet clear of other boat and never hold towline after it is pulled taut.

Move slowly to prevent sudden strain on slack line.

Be ready to cast loose or cut the line if conditions become hazardous.

Anchoring

There are many types of anchors available on the market. The choice on which one to choose depends on the usage. Contact your dealer on what anchor would suit your situation.

WARNING



Always anchor from the bow of the boat. The boat has less chance of breaking free if a heavy wind comes.

Propellers

CAUTION



- ***A propeller can be very sharp. Be careful when you handle it. Wear a pair of protective gloves when handling any propeller.***
- ***Remove your key from the ignition to prevent accidental starting of the engine.***
- ***DO NOT reuse the nylon locknut or the cotter pin.***

NOTICE

DO NOT use a damaged propeller. A damaged propeller can damage your engine and/or your boat.

Nothing is more important to the proper performance of your boat than the condition of the propeller. Even slight propeller damage can mean the loss of one MPH. Greater damage can mean considerably more speed loss. Worse yet, damage usually is not done to each blade uniformly and, therefore, sets up imbalanced vibrations that can cause fatigue damage to other parts of the engine or drive system.

Your propeller is custom calibrated for your Malibu by our Research and Design team to give maximum performance. Before installing props other than those suggested by Malibu contact your dealer, otherwise adverse handling and top speed characteristics may be experienced.

The prop is identified by two numbers, i.e., 13 x 14, and material identification such as brass or stainless steel. The first number is the diameter of the prop and the second is the pitch. The pitch is the angle of the blades and is measured in how far the boat will travel through the water in one revolution. In this case, for every one revolution the boat will travel 14 in.

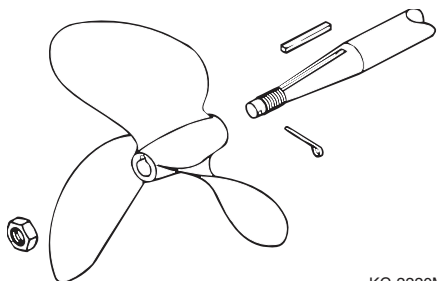

KC-2220M

Figure 3-11. Propeller

NOTICE

DO NOT operate engine above the manufacturer's recommended RPM rating; severe damage could result, voiding the warranty.

At least once a year, more often if you use your boat extensively, you should have your local Malibu dealer inspect the propeller for any possible damage.

At least once a month, if you use your boat regularly, you should check and tighten the prop nut. If it is necessary to remove the prop, use care. If the prop is not removed correctly, damage could result if it comes off the shaft too quickly and hits the ground. Whenever possible, use a prop pulling tool to remove prop, this will reduce the chance of damaging the prop.

Removal

- 1) Remove the cotter pin from the propeller shaft and discard.
- 2) Wedge a piece of 1" x 4" wood between the propeller blade and the starboard side of the strut and rudder.
- 3) Loosen the nylon locknut and unthread it until it is flush with the end of the prop shaft.
- 4) Use a propeller puller to separate the prop from the taper on the shaft. Holding the prop with one hand, remove the nylon locknut and discard.
- 5) Remove the propeller, then remove the key from the keyway. Inspect the keyways and key for any damage.

Installation

Before installing the prop, look at the keyway on the shaft and in the propeller. The key should slide freely in both keyways. DO NOT use the prop nut to advance the prop onto shaft.

If the key has slight damage or burrs, remove them by filing the flat sides or replace the key. DO NOT file the key beyond its normal shape or size.

- 1) Rotate the shaft until the keyway is "up."
- 2) Place the key in the shaft keyway. Align the keyway in the prop to the key. The prop will only slip on in one direction. Once the prop starts to go on the shaft, push the propeller "solidly" on the shaft and make sure you feel that it is seating properly.
- 3) Wedge a piece of 1" x 4" wood between the propeller blade and the port side of the strut and rudder.
- 4) Install a new nylon locknut and torque the nut to maximum of 30 ft-lbs (40.7 N•m).
- 5) Install new cotter pin. Bend the retaining ends of the cotter pin in the opposite directions. Make sure the cotter pin is snug and cannot rotate.

Malibu Exclusive Adjustable Rudder System

Your Malibu steering is custom calibrated at the Malibu factory at the time of manufacturing. However, it may be necessary from time to time to adjust the steering due to normal operations. Malibu Boats' unique adjustment feature allows custom calibration to your specific driving needs. The Malibu Adjustable Rudder system allows you to increase or decrease the amount of load that is typically on the steering system.



Figure 3-12.
Adjustable Rudder

If it is determined that your rudder needs adjustment, you can do so by adjusting tunable feature located on the rudder surface. Locate the 1/8" set-screws. Loosening the set-screws will release the adjustment tab. If your boat pulls to the right, turn the tab to the right 1/8th to 1/4". Do not move beyond this point. Only minor adjustments are needed to make a correction. Note that it may take more than one adjustment to get the desired setting. Tighten the set-screws when adjustment is completed.

WARNING

Make sure the set-screws are tightened after each adjustment. Failure to tighten the set-screws could cause erratic steering and serious damage could result. If you are unsure of the correct procedure to conduct this adjustment, it is recommended that you return your boat to your local Malibu Boat dealership for assistance.

Corrosion Protection

Galvanic corrosion (electrolysis), is the break-up of metals due to the effects of electrolytic action. When two dissimilar metals are immersed in a conductive fluid such as salt water, an electric current is produced, similar to that of a battery. As the current flows, it takes with it tiny bits of the softer metal. If not stopped, a great deal of damage can occur.

If you operate your boat in salt or brackish waters, you should have your boat equipped with a transom mounted zinc anode to prevent damage to the parts coming in contact with the water. The zinc anode being the softer metal will deteriorate and erode much faster than the other metals in the boat. Inspect the anode periodically and replace as needed. Consult your local Malibu dealer for this part.

Saltwater Corrosion

If you use your boat in salt or brackish water, wash the entire boat, including trailer and tower (if fitted), thoroughly with a mild detergent and rinse with fresh water after EVERY USE. Apply a corrosion inhibitor to all hardware regularly. Consult your dealer for products suitable for the marine saltwater environment and proper usage instructions.

Malibu strongly recommends freshwater internal engine flushing after using the boat in salt, polluted or brackish waters. Flush the entire cooling system with fresh water for at least five minutes after use in these waters. See your Malibu dealer for appropriate flushing devices and additives.

NOTICE

Salt water is commonly very harsh on all components of boat. Saltwater corrosion is not covered under your Malibu Boat or engine manufacturer warranties. It is the boat owner's responsibility to understand and ensure they have taken proper precautions to safeguard boat.

Chapter 4

CARE AND MAINTENANCE



The following guidelines discussed in this section will protect the investment you have made by preserving the beauty and performance of your new boat for years to come.

Interior

Carpet

Your Malibu boat is equipped with a top quality, all-weather indoor/outdoor carpet. It is essentially waterproof and fade resistant. Occasional vacuuming and scrubbing with soap and water will remove embedded dirt and grit.

Vinyl

All upholstery items aboard your boat are made of a tough marine vinyl that is easily cleaned with a mild detergent and warm water. After washing the vinyl, be sure to dry it thoroughly.

Our materials are mildew resistant, but there are no products available to us that are mildew proof. Therefore, we also recommend that you dry the upholstery thoroughly at the end of each day's boating activity to prevent mildew which will rot the upholstery threads and backing. We also recommend that you tip up all seat base cushions on edge after each use to allow any accumulated water to drain.

NOTICE

In some instances, color or dye transfer can occur when wet clothing comes in contact with vinyl. If this occurs, the vinyl should be cleaned immediately to avoid permanent staining. Unfortunately, due to the porous nature of the upholstery, you may find that the dye has set into the vinyl surface, and you cannot remove it. If this should occur, it is recommended that you contact Final Finish/MSG to get assistance in cleaning.

Upholstery finish stains caused by secondary sources are not covered under your Malibu Boats Warranty.

It is important to keep your vinyl clean at all times. Some substances can stain the vinyl if you leave them on for even a short period. Remove any contaminant and clean the area immediately. Some household cleaners, powdered abrasives, steel wool, industrial cleaners, dry cleaning fluids and lacquer solvents can damage and discolor. Failure to care for your vinyl properly, or use of improper cleaners may damage the vinyl and void your warranty.

DO NOT use products such as acetone, ArmorAll®, bleach, baking soda, Fantastik®, Formula 409®, gasoline, kerosene, Murphy® Oil Soap, Simple Green®, Son of a Gun!® or any silicone based protectants. DO NOT clean your vinyl with power washers, as they can generate pressures up to 3,500 psi and could damage the surface of your interior.

Common stains and steps to treat:

Type of Stain	Step #1	Step #2	Step #3
General care	A	B	
Dirt buildup	A	B	
Ballpoint ink*	B	A	
Chewing gum	B	A	
Coffee, tea, chocolate	B	A	
Grease	C	B	A
Household soil	A	B	
Ketchup	A	B	
Latex paint	A	B	
Lipstick	C	A	B
Mildew or wet leaves*	B	A	
Motor oil	C	B	A
Oil-based paint	C	B	A
Permanent marker*	B	A	
Spray paint	B	A	
Suntan lotion*	A	B	
Tar/asphalt	C	B	A
Yellow mustard	A	B	

A. Medium-soft brush, warm, soapy water, rinse/dry

B. 303 Fabric and Vinyl Cleaner®, rinse/dry

C. Wipe or scrape off excess (chill gum with ice)

After all cleaning methods, rinse well with clear, warm water.

NOTICE *Always allow the boat to dry completely before covering it for storage. Covering a wet boat will trap moisture, allowing for mold and mildew to grow. Stains from mold and mildew will not be covered by the Malibu boat warranty.*

* Suntan lotion, tree pollen, wet leaves and some other products, including waxes, can contain dyes that stain permanently.

The Plexiglas walk-through windblock should only be cleaned with mild, soapy water and a soft cloth. Ammonia-based or harsh chemical cleaners will damage the Plexiglas.

Instrumentation

The in-dash graphical display, the MaliView screen, gauges and digital switch lenses should only be cleaned with a damp, soft cloth with mild, soapy water. Ammonia-based or harsh chemical cleaners will damage the lenses.

To care for the Malibu Touch Command, lightly wipe the surface of the touch screen using a dry cloth or soft cloth with isopropyl alcohol or neutral detergent for cleaning the touch screen in case of dirt or residue. Never use glass cleaners, which contain ammonia. Never use organic solvents on the touch screen, except alcohol.

Exterior

Your Malibu boat is highly resistant to weathering, water pollution and minor scrapes which occur during normal use. However, regular care and maintenance of your boat is a general responsibility for all Malibu boat owners. By following the boat care instructions listed below, you will be able to extend the life and beauty of your Malibu boat.

Hardware

Most of the metal hardware on your boat consists of brass, stainless steel, or aluminum and should be cleaned on a periodic basis with soap and water. In fresh water, metal fittings and hardware should be sprayed regularly with a rust inhibitor and after every use in saltwater.

DO NOT use cleaners that are not intended for use on stainless steel. Glass, tile, counter or citrus cleaners can damage hardware permanently. Always follow cleaning, by applying a high-quality metal polish or automotive wax after cleaning. Test products in an inconspicuous area before applying to the complete surface, especially if you are not familiar with the product.

All metal parts, including but not limited to tower accessories, board racks or speaker cans, should be cleaned with mild soap and water frequently and waxed periodically. A corrosion protectant is highly recommended on these components, especially for use in areas of or in proximity to salt/brackish water. Pitting, corrosion or oxidation is not covered under warranty. Pitting is not the same as separation.

Fiberglass and Gelcoat

The fiberglass hull and deck of your Malibu boat consist of a molded shell and exterior gelcoat. The gelcoat protects the fiberglass shell and gives all Malibu boats a smooth and shiny surface. The following are some general instructions which will help you maintain your boat's sleek appearance:

- 1) Wash monthly or more frequently, depending on use. Use a mild dish washing soap and lukewarm or cold water. Rinse your boat with fresh water and wipe down immediately to avoid water spots.
 - 2) Wax the boat hull and deck after every three or four outings to decrease water friction and to lessen the potential for staining or spotting the gelcoat surface. In cases where the original gelcoat shine cannot be restored by waxing, hand buff the surface using any commercial compound. Be sure to apply several coats of wax over the area that has been polished.
-

Surface Stains

Stains can appear as a result of dust, road tar, plant sap, rust from metal fittings and other materials coming in contact with your boat's exterior. Listed below is a step-by-step procedure to remove stains from your boat:

- 1) Wash area with dish washing soap
- 2) Apply a mild cleanser on a small area (3 x 3 ft)
- 3) Rinse with fresh water
- 4) Buff with a fine rubbing compound
- 5) Wax

If the stain is not removed by the dish washing soap or mild cleanser, then the next procedure is to use either denatured or rubbing alcohol. Common rubbing alcohol is excellent for removing stains.

Scratches

Scratches to the gelcoat sometimes occur during normal use. Your dealer can usually restore the gelcoat to like-new condition.

Underwater Corrosion

Corrosion occurs in saltwater conditions from the interaction of the saltwater and the direct current of the battery. To prevent corrosion, it is important to keep the bilge area as dry and clean as possible.

Care for Boats that are Moored

Due to gelcoat discoloration, osmosis (blistering) and algae growth, it is not recommended that you leave your boat moored for 21 days or more. If your boat will be moored in fresh water or saltwater for extended periods of time, you should do the following:

- 1) Haul-out and clean your boat regularly (every 14 to 21 days). Use soap, water and plenty of elbow grease.
- 2) Apply wax after cleaning.

You should also check with your local Malibu dealer about anti-fouling paint and other products that can be applied to the hull bottom below the water line.

If the boat will be moored for more than 21 days, we recommend applying an anti-fouling paint.

Teak Wood

Care must be taken to keep teak wood from turning gray or rough. The roughing becomes more apparent as the moisture evaporates and dries out.

It is suggested that you use teak or mineral oil treatments at least four times a year to maintain the appearance of your swim platform. Use a high-quality teak oil which can be purchased at your local Malibu dealership.

For additional information on care, maintenance and warranty on your swim platform, please see the information provided in your Owners Packet.

NOTICE

Teak sealers and cleaners can damage other materials. Make sure you thoroughly remove any spills or excess. Teak should not be varnished. The natural oils in teak cause poor adhesion.

WARNING

Avoid fire or explosion onboard. DO NOT store rags used to treat teak onboard. Store or dispose of rags properly ashore.

Engine/Drive Train

Please refer to the appropriate engine manual for engine/transmission service, maintenance, and/or Customer Support.

Steering System

Hydraulic steering systems require specific hydraulic fluids. Please consult your dealer for details.

Rudder Stuffing Box

The rudder has a grease fitting located on the exterior of the boat on the rudder base and requires periodic maintenance.

Prop Shaft/Engine Alignment

As per Indmar's recommended routine service maintenance, it is necessary to regularly evaluate the prop shaft coupler bolts that attach the prop shaft to the engine. See Indmar Owner's Manual for proper prop shaft alignment. If the prop shaft bolts loosen prematurely, major damage to your boat structure and driveline could result. It is recommended that only a trained service technician perform this maintenance due to the complications that can arise from an improperly balanced prop shaft engine alignment.

NOTICE

Damaged caused from loosened coupler bolts and improper engine alignment is not covered under your Malibu Boats warranty, and should be part of the owner's service responsibilities to ensure system is correct. See Malibu Boats and Indmar Owner's Manuals for appropriate timelines for evaluation or checkup.

Optional Drip Less Shaft Packing

The optional drip less shaft packing provides drip-free use of your prop shaft coupling and will require minimal maintenance to keep the system trouble-free. Grease fitting annually, and ensure water flow tube is free from obstruction. The system uses lake water from the engine to assist in cooling. If the cooling hose is removed, water can enter the bilge area of the boat while the engine is running.



Figure 4-1. Drip Less Shaft Packing

Fuel System

Fuel System

All Malibu Boats are equipped with Pump-in-tank (PIT) fuel systems. This means the fuel pump is no longer mounted on the engine and is now located in the fuel tank. There are many benefits to using Pump-in-Tank; most notably is the prevention of vapor lock and improved filtration of contaminants.

This is a “High Pressure” fuel system. If you ever smell a strong fuel odor, shut down immediately and inspect for leaks.

NOTICE *The PIT fuel system is not to be serviced by anyone other than a Malibu Factory Trained and Certified Technician. Special tools and training are required to service this fuel system.*

Do not use fuel containing more than 15% MTBE. Also, fuel containing more than 10% ethanol or grain alcohol is not recommended. A higher percentage of either of the two fuel additives can cause damage to the engine and fuel system.

DO NOT mix MTBE and ethanol. Drain your tank, or use up as much of the old fuel as you can before making the switch to E10. Once done, do not go back to MTBE gas. Also, drain the tank when storing the boat, and put in additives.

Does the gas you are buying have ethanol or MTBE? By law, roadside stations must put stickers on pumps designating whether the gas has ethanol and how much. A lot of marinas do not put up stickers, so ask.

Find out when your fuel provider switched to E10 and how it was done. Old fuel and water should have been removed and the tanks cleaned to reduce the possibility of the ethanol loosening up old sludge. If they mixed ethanol with MTBE, you could be pumping a potential disaster into your boat.

Mixing the two additives can and will cause damage to the engine and fuel system which will void all warranties supplied by Malibu Boats LLC, and Indmar Engine Company.

Refer to the engine owners manual for further information.

Green Fuel System

The only maintenance required for the new Attwood fuel system is that all hose connections be inspected annually for tightness.



Figure 4-2. P-Trap and Deck Fill

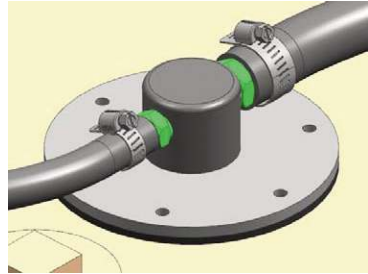

Figure 4-3. FLVV

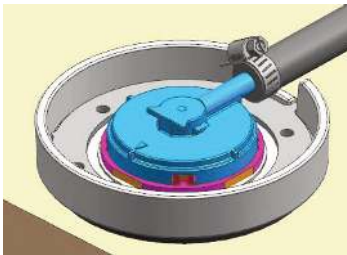

Figure 4-4. GRV

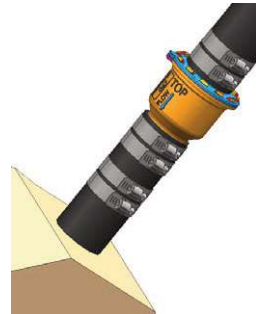

Figure 4-5. ICV

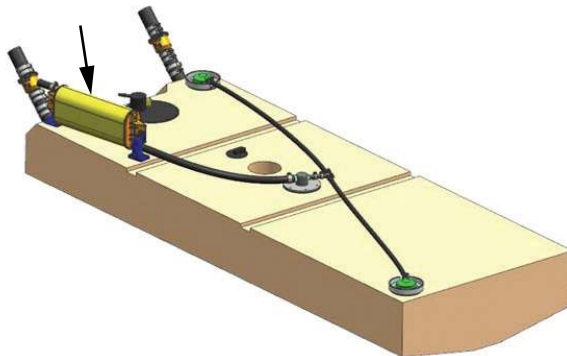

Figure 4-6. Attwood Carbon Canister

Replacement Fuel System Components

Should any part of the fuel system become damaged, it is required that the correct replacement Attwood part be used.

Electrical

Engine Circuit Breaker

Depending on your engine model, the engine may be equipped with a 35 AMP Circuit Breaker to protect the engine electrical system and components from overload, and is found on the lower right side of the engine. If your engine should lose power and will not crank, reset the breaker by firmly pressing the red button (an audible sound will be heard). For additional engine electrical issues, see your Engine Owners Manual, or contact your Local Malibu dealership.

Main Circuit Breaker

Located adjacent to the battery is a 80 AMP Circuit Breaker. If your boats systems lose electrical power, and you have no dash gauges or your engine does not turn over, you will need to reset the breaker to restore power to your boats systems. To reset, find breaker switch and depress until lever locks into position.



Figure 4-7. Main Circuit Breaker

WARNING



Power loss to the Main Breaker is an indication of serious issues to your boats electrical and/or engine components Contact your local dealer for evaluation of these components.

NOTICE

If additional loads are added to the dash feeder circuits, such as amplifiers, tower lights, etc., this can overload the 80 AMP breaker. Large loads over 20 AMPS should be wired directly to the battery with proper overload protection.

Boat Alarms

Malibu boats are equipped with sensors that constantly monitor various functions of the boat. Certain functions, if outside of pre-determined operating parameters, may activate an alarm located under the dash. Both the engine Electronic Control Module (ECM) and the dash gauge computer may activate the alarm.

If the ECM activates the alarm, it will store a trouble code in memory. Stop the boat as soon as possible and turn off the engine. You will need to have your Malibu dealer run a diagnostics test to repair the engine and clear any codes from memory. The ECM uses the engine oil pressure, engine temperature and transmission temperature switches for input and parameters are stored in the ECM.

If the dash gauge computer activates the alarm, the Multi Function Display Panel will indicate the source of the problem. If the alarm sounds during operation, stop the boat as soon as possible and turn off the engine. You will need to have your Malibu dealer run a diagnostics test to repair the engine and clear any codes from memory. The dash gauge computer uses a separate set of sending units on the engine, fuel tank and depth transducer for input and parameters are stored in the computer.

Refer to Section 3, *Operation, Starting*, for more information on the alarm.

Go Home Feature

The “Go Home” feature will enable the navigation lights (bow and tower) to illuminate whenever the driver uses the hard-key to start the engine instead of the touch screen.

Battery

A minimum of 650 cold cranking amps is the recommended battery size.

NOTICE *Do not connect battery cables to incorrect Terminal Post ±. Doing so may cause a reverse polarity current to run through your electrical system and cause damage to your engine and other electrical components. Damage done to your boat due to incorrect terminal placement is not covered under your Malibu warranty.*

Check your battery terminals frequently for corrosion and tightness. Clean terminals with a baking soda and water solution and a wire brush. Also, check the fluid levels in the cells. Usually, a level approximately 1/4 to 1/2 in. above the plates is sufficient. If needed, fill with distilled water. Some batteries are sealed and this process is not necessary. Read directions when applicable.

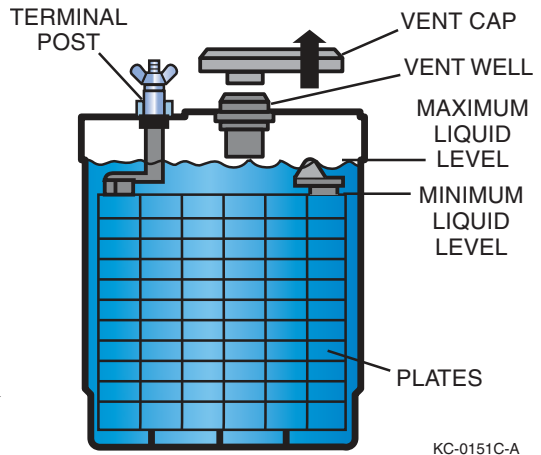

Figure 4-8. Battery Level

Electrical Distribution-Battery Switches:

All main engine battery cables are the larger, 2/0 size. Always use a Starter/Cranking battery, minimum size of 650 Cold Cranking Amps on the big cable. This is the starter or cranking circuit.

There are also a set of smaller #2 AWG battery cables with the positive/red coming from an 80-AMP main circuit breaker (on the smaller boats, a #6 AWG cable and a 60-AMP main breaker). These smaller cables are the feeder circuit to the boats breakers and switches. These are referred as the House circuit.

#1 on a Single Battery System:

Both the cranking circuit and the house circuit are connected to the same battery. One battery running everything all connected together.

#2 on a Dual Battery System:

With a battery selector switch commonly called a “battery isolator switch”; both the house and the cranking circuits are always connected together at the selector switch. You have the ability to switch between 1-2 or all of the batteries to connect to the house and starter circuits. The current to charge the batteries, will come from the starter circuit, flowing from the engine alternator to the battery switch common terminal. When the engine is running you will have the ability to charge either #1 or #2 or both of the batteries at the same time.

When the engine is off, you will pull current for both the house and cranking circuit on which ever battery you have selected or both batteries. With this system you are required to manage the battery system, keeping both batteries charged and never run the second battery dead. Sitting listening to an amplified stereo system with the selector switch on “all” with lights on can drain both batteries. The best feature of this switch is you can disconnect the electrical system of the boat and engine, and the amperage draw for the computers and stereo memory during long and short term storage will be minimal. To maintain optimum performance, make sure to manage the batteries properly.

Option #3, Dual Circuit Plus Battery Switch with VSR:

The Power of three switches in one!

- Simple On/Off switching
- Normal “ON” position isolates the starting and house circuits to reduce the chance of fully discharging both batteries and protect on board electronics from engine starting voltage sags and spikes.

The “Combine Batteries” Position parallels the two battery banks in the event of a low starting battery.

The VSR manages the charging of the house battery bank automatically. The voltage sensitive relay is basically a switch that connects the cranking circuit battery to the house circuit battery, once the starter battery is fully charged. This allows the house circuit to be separate from the cranking circuit completely. This is a true isolated, separate set of circuits; house and cranking with two separate batteries. The common ground connection and this VSR switch are the only way these two separate circuits can connect. The switch is normally open, but once the engine is running and the voltage comes up on the starting battery and it is fully charged, the VSR switch closes, allowing charge current to flow into the house battery. This allows the alternator to supply current to charge the house battery and supply operational current to house loads.

Once you shut down and the alternator is no longer charging, the VSR switch will open, separating the two circuits again. Again the VSR has allowed two circuits to be separate, so now any power you draw with the engine off; will come from the house battery. You can listen to the stereo until the house battery is dead, but you can have the peace of mind knowing that all you have to do is turn the key and your boat will start. No fumbling with any switches, it’s all automatic.

Now that we have separated the house and cranking circuits, we can use batteries designed for specific uses. You always need a cranking battery for the cranking circuit, but now you can use a deep cycle battery on the house circuit. Deep cycle batteries will handle the load and discharge cycles much better than cranking batteries on the house circuit. A group 24 high-ampere hour deep cycle battery is recommended for the isolated house circuit.

If you have a large stereo system and you spend a lot of time listening to it with the engine off, upgrading the house battery system to two battery's will extend the amount of time you can listen to the system before the batteries are dead and require charging. Using two deep cycle batteries in parallel on the house circuit will dramatically increase the amount of time you can listen to high end stereo systems. Contact our dealer for a battery system upgrade.

The cranking battery is the primary battery that is only used to start and operate the engine. Having the cranking circuit truly isolated from the house circuit is the ultimate upgrade; it prevents cranking voltage spikes from causing any problems with the onboard computer network. With the VSR equipped systems, you will notice that when you turn on the key, the stereo will come to life as will the dash instrumentation, yet when you crank the engine over to start, they never blink. The stereo never skips a beat and the instrumentation stays powered.



Figure 4-9. Battery Switch

Battery Isolator Switch

This option provides the ability to isolate the boat batteries if more than one battery is used. If so equipped, the isolator switch is located behind the front observer's seat under the dash next to the battery. Under normal situations, the switch should be in "position 1" or "position 2" rather than in the "all" position. This will keep one battery charged should one of the batteries fail.

Circuit Breakers and Fuses

Most electrical standard equipment devices are controlled with circuit breakers. These breakers will activate if overloaded and cut power to the switch. To restore power, simply push the breaker button in and release. Breakers do not require fuse replacement. The breaker panel can be found under the dash next to the 12-V adapter. The stereo, if so equipped, has an inline fuse. If your stereo should quit working, check fuse as well as the breaker.

12-V DC Accessory Outlets

All models are equipped with two 12-V DC Accessory Outlets; one on the electrical panel below the dash, and one in the glove box. These outlets provide power from your boat battery to accessory equipment such as cellular phones, video cameras, marine spot lights, etc.

Miscellaneous

Hardware

Most of the metal hardware on your boat consists of brass, stainless steel, or aluminum and should be cleaned on a periodic basis with soap and water. In fresh water, metal fittings and hardware should be sprayed regularly with a rust inhibitor and after every use in saltwater.

DO NOT use cleaners that are not intended for use on stainless steel. Glass, tile, counter or citrus cleaners can damage hardware permanently. Always follow cleaning, by applying a high-quality metal polish or automotive wax after cleaning. Test products in an inconspicuous area before applying to the complete surface, especially if you are not familiar with the product.

All metal parts, including but not limited to tower accessories, board racks or speaker cans, should be cleaned with mild soap and water frequently and waxed periodically. A corrosion protectant is highly recommended on these components, especially for use in areas of or in proximity to salt/brackish water. Pitting, corrosion or oxidation is not covered under warranty. Pitting is not the same as separation.

Bilge

The bilge of your boat can accumulate oil and greasy dirt over a period of time and should be cleaned out periodically. Usually, ordinary soap and water does not remove the accumulation and something stronger will be needed. Check with your Malibu dealer for recommendations.

Windows and Windshields

The windows and windshields on your Malibu boat are made of tempered safety glass and are similar to the windows in your car. The glass will scratch however, and abrasive cleaners should not be used to clean your windows. Soap and water or automotive glass cleaners may be used.

Winterizing

When the boating and ski season comes to an end, it is recommended that the boat be removed from the water and stored. It is extremely important that proper winterizing procedures are read and followed to ensure longer boat life. Here is our list of suggestions to keep your boat in top condition:

- Prepare the engine according to the instructions found in your engine owner's manual. It is our recommendation that you contact your local Malibu dealer for full winterization procedures.
- Clean and dry the boat interior and exterior thoroughly. Inspect boat hull for residue and remove any if present.

-
- Clean the bilge area thoroughly and operate the bilge pump to remove any water from bilge lines.
 - Remove all seat cushions and open all storage areas. Store the seat cushions in a cool and dry place.
 - Cover the boat and store it in a garage or other protected facility.
 - If the boat is stored on a trailer, you should block the trailer wheels.

Storage and Winter Lay-up

Due to the problems that can occur from improper winterization, we recommend that you take your boat to a certified Malibu dealership to perform this task. Without proper preparation, storage for long periods of time may cause parts of the engine and transmission to rust due to lack of lubrication. Also, if your boat will be stored in freezing conditions, water inside these components to include cooling system, heater and shower could result in major damage to your boat. Damage done due to improper winter storage will void your warranty. Here is our list of suggestions to keep your boat in top condition. Prior to boat being removed from water:

- Fill fuel and add 1 ounce of **STA-BIL**[®] fuel stabilizer for each 5 quarts of gasoline.
- Operate boat for at least 15 minutes in water or using a flush system to allow treated fuel to flush engine.
- Add lightweight engine oil (SAE-10 or fogging oil) slowly to the engine while engine is slightly above idle. Turn engine off. Consult your local dealer for correct procedure.

To be completed when boat is put on trailer or resting cradle:

- Remove bilge T-handle and transom drain plug immediately after removing the boat from the water and drain all ballast tanks.
- Clean and dry the boat interior and exterior thoroughly. Inspect boat hull for residue and remove if present.
- Clean bilge area thoroughly and operate the bilge pump to remove any water from bilge lines.
- Remove all seat cushions and open all storage areas. Store the seat cushions in a cool dry place.
- Apply coat of wax to entire gelcoat surface of boat.
- Flush engine-cooling system with clean water. Do not exceed 1500 RPM while flushing for 5-10 minutes.
- Perform annual scheduled maintenance. Refer to engine owner's manual for complete engine winterization procedures as well as scheduled maintenance.

Note: Damage done due to improper engine winter storage will void your warranty. It is highly suggested that you allow a trained Malibu technician to perform this service.

- After performing engine winterization, remove engine safety switch and spin engine over a few seconds to remove excess water found in pump bodies.
 - Remove the negative cable from battery. Charge battery to full charge and remove from boat.
 - Clean all traces of dirt, oil and grease from engine, transmission and bilge. Coat all areas on transmission and engine where paint has been removed with touchup paint.
 - Use duct tape to seal the exhaust flaps closed to prevent dirt and rodents from
-

entering exhaust.

- Remove propeller assembly, and store in safe place.
- If your boat is equipped with an optional heater or hot-water shower, remove both hoses and blow through hose to remove excess water.
- Cover the boat with cover, tarp or, if available, shrink-wrap tarp. Also, due to the excess weight that can occur from rain and snow for boats that are stored outside, it is suggested that you make a support of 2 inch PVC piping that can be mounted under the covering material. The rounded PVC piping will ensure the cover does not tear and will eliminate pooling water inside boat.

Winterization Re-Commission

- Remove boat cover or shrink-wrap from boat.
- Remove Duct tape from exhaust flaps.
- Charge and install battery in boat. Follow all safety precautions associated with changing batteries.
- De-winterize engine using engine manufacturer's specifications.
- Check propeller shaft alignment. Tighten coupling hardware.
- Check engine compartment for nesting animals. Clean as needed.
- Reinstall seat cushions from storage.
- Check entire engine for signs of cracks caused by freeze damage. Check all hose clamps for tightness. Install bilge drain plugs: transom, T-handle plug and ski locker drain plug.
- Reinstall propeller assembly.
- If not performed during winterization, perform annual maintenance at this time.
- If boat is equipped with optional fresh-water cooling, and was drained at winterization, fill at this time.
- With the boat in the water or using a flush kit, turn key on and off 2-3 times to allow fuel to return to engine, then start engine. When engine starts, watch gauges closely, and watch for abnormal readings.

Troubleshooting

The following charts will assist you in finding and correcting minor mechanical and electrical problems with your boat. Problems are listed in the order of the most likely event to the least likely.

To correct a problem, first determine what the problem is. Start with the first cause and eliminate the possibility of each until the problem is corrected. Because of the specialized skills and tools needed to correct major issues, we have not included that information. If you suspect a problem not listed here, please contact your Malibu dealer.

PROBLEM	POSSIBLE CAUSE	SOLUTION
Engine will not turn over	<ul style="list-style-type: none"> • Throttle control in gear. • Main circuit breaker open. • Weak or dead battery. • Poor or loose battery connections. 	<ul style="list-style-type: none"> • Shift into neutral. • Reset circuit breaker. • Charge or change battery. • Clean and tighten battery cable connections.
Engine turns over, but will not start	<ul style="list-style-type: none"> • No fuel in tanks. • Contaminated Fuel. • Distributor Problems. 	<ul style="list-style-type: none"> • Fill fuel tank. • See your dealer. • See your dealer.
Engine is hard to start	<ul style="list-style-type: none"> • Flooded engine. • Plugged flame arrestor. • Fouled spark plugs. • Loose coil or ignition wires. • Battery cables loose or corroded. • Weak battery. • Ignition problems. 	<ul style="list-style-type: none"> • Start engine full throttle and back off. • Clean flame arrestor. • Replace spark plugs. • Tighten coil or ignition wires. • Clean and tighten battery cables. • Charge or replace the battery. • See your dealer.
Engine misses or idles rough	<ul style="list-style-type: none"> • Fouled spark plugs. • Loose or defective high-tension leads. • Plugged PCV valve. • Weak ignition coil. • Vacuum leak. 	<ul style="list-style-type: none"> • Replace spark plugs. • Tighten or replace the high-tension leads. • Replace PCV valve. • Replace ignition coil. • See your dealer.
Poor boat performance	<ul style="list-style-type: none"> • Fouled spark plugs. • Plugged flame arrestor. • Weak ignition coil. • Contaminated fuel. • Fuel filter clogged. • Ignition problems. 	<ul style="list-style-type: none"> • Replace spark plugs. • Clean the flame arrestor. • Replace the ignition coil. • See your dealer. • See your dealer. • See your dealer.
Poor gas mileage	<ul style="list-style-type: none"> • Fouled spark plugs. • Plugged flame arrestor. • Inefficient driving habits. • Plugged PCV valve. • Ignition problems. 	<ul style="list-style-type: none"> • Replace spark plugs. • Clean the flame arrestor. • Plan the boat quickly, then slow down to desired speed. • Replace PCV valve. • See your dealer.

PROBLEM	POSSIBLE CAUSE	SOLUTION
Throttle/shifting problems	<ul style="list-style-type: none"> • Corroded cables. • Defective throttle return spring. • Low transmission oil level. • Sticking transmission shift detent ball. • Kink in cables. 	<ul style="list-style-type: none"> • Clean and lubricate cables. • Replace the throttle return spring. • Replenish the transmission fluid. • Clean and lubricate detent ball. • Replace the cable(s). See your dealer.
Steering problems	<ul style="list-style-type: none"> • Corroded cables. • Rudder worn. 	<ul style="list-style-type: none"> • Clean and lubricate the cable. • See your dealer.
Excessive vibration.	<ul style="list-style-type: none"> • Damaged propeller. • Misaligned propeller shaft coupling. • Bent propeller shaft. 	<ul style="list-style-type: none"> • Replace the propeller. • Check the alignment. See your dealer for proper realignment. • See your dealer.
Electrical problems	<ul style="list-style-type: none"> • Open circuit breaker or blown fuse. • Loose wiring connections or corrosion. • Defective sending unit. • Shorted wiring harness. • Defective switch or gauge. 	<ul style="list-style-type: none"> • Reset the circuit breaker or replace the fuse. • Clean and tighten wiring connections. • Replace the sending unit. • Repair the wiring harness. • See your dealer.
No speedometer	<ul style="list-style-type: none"> • Paddle Wheel. • Defective speedometer. 	<ul style="list-style-type: none"> • Replace the paddle wheel. • Replace the speedometer.
Incorrect speedometer	<ul style="list-style-type: none"> • Paddle Wheel. • Defective speedometer. 	<ul style="list-style-type: none"> • Replace the paddle wheel. • Replace the speedometer.

Glossary

AFT:	To the rear of the boat near the stern. Generally used to give directions.
BEAM:	The widest portion of the hull.
BILGE:	The lowest portion inside the boat. This is generally the section directly below the engine compartment.
BOW:	The forward portion of the boat.
BULKHEAD:	Vertical portion in a boat.
CHINE:	The intersection of the sides and bottom of a “V” bottom boat.
DEADRISE:	The degree of angle from the keel to the chine.
DECK:	Upper structure which covers the hull.
DRAFT:	Vertical distance from the waterline of the boat to the lowest part of the boat.
FibECS II:	An engine mounting method, using fiberglass instead of other materials such as aluminum or steel; patented by Malibu Boats LLC. that provides major reduction in noise and vibration.
FIBERGLASS:	Fibers similar to wool or cotton, but made from fibrous glass. Glass fiber forms include cloth, yarn, mat, milled fibers, chopped strands, roving and woven roving.
GELCOAT:	A surface, either colored or clear, providing a cosmetic enhancement and exposure improvements to a fiberglass laminate.
GUNNEL:	The upper edge of a boat’s side.
HELM:	Device attached to rudder for steering a vessel.
HULL:	The bottom section of the boat.
KEEL:	The lowest most portion of the bottom of the boat.
LIFTING STRAKES:	Strips molded or attached to the surface of a hull designed to create lift as speed and pressure increase with the static water.
PORT:	To the left side of the boat, when facing the bow.
STARBOARD:	To the right side of the boat, when facing the bow.
STERN:	To the rear of the boat.
STRINGER:	Longitudinal members that are fastened inside the hull of the boat which provide structural integrity.
TRANSOM:	The area forming the stern, or rear, of a boat.
WAKE:	The track or path a boat leaves behind while in motion.
WORKING DECK:	Floor within cockpit or bow area.

Index

A

Anchoring 3-15

B

Basic Rules of the Road 1-32

Basic Safety Rules. 1-3

C

Care and Maintenance. 4-1

Circuit Breakers 2-27

Closed Cooling System. 2-57

Corrosion Protection 3-18

D

Docking 3-13

Drain Plugs 2-54

Driver's Seat 2-48

E

Electrical 4-8

Emergency Engine Stop Switch 2-46

Emergency Procedures 1-54

Engine Compartment Fire Extinguisher 2-47

Engine/Drive Train 4-5

Exhaust 2-56

Exterior 4-3

F

Fuel System. 4-6

Fueling 3-6

G

Gauges and Controls 2-1

General Boating Safety Topics 1-16

Glossary. 4-18

Go Home Feature. 2-51, 4-9

H

High-Speed Operation. 3-14

I

Integral Self Draining Ice Chest 2-49

Interior. 4-1

Introduction. vii, 1-1

M

Malibu Boats Limited Warranty W-1

Malibu Exclusive Adjustable Rudder

System 3-17

Miscellaneous 4-12

Motorbox Cover 2-48

N

Navigational Lights. 2-51

O

On Product Warning Labels 1-29

Operation. 3-1

Optional Equipment 2-57

Owner Responsibility and Boating

Education. 1-8

P

Power Wedge 2-25

Propellers. 3-16

S

Safety and Required Equipment 1-10

Shifting/Running. 3-10

Ski Pylon 2-50

Speedometer Pickup 2-55

Standard Gauges 2-1

Starting 3-8

Steering 3-11

Steering System 2-46, 4-5

Stopping 3-13

Storage Areas 2-52

Sundeck. 2-49

Swim Platform 2-50

Switches & Indicators. 2-27

T

Table of Figures. vi

Throttle Control. 2-45

Tilt Steering Wheel. 2-55

Tower 2-67

Towing Another Boat 3-15

Trailing. 3-1

Troubleshooting 4-15

V

V-Drive Engine Access Hatch 2-49

Ventilation. 2-56

Viper Chart Plotting Instructions 2-69

VTX Table Installation 2-53

W

Watersports Safety 1-44

Wedge 2-91

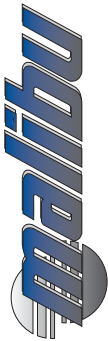

Maintenance Worksheet

Please circle one- Pre-delivery-/10hr.-/50hr.-/100hr.-/Annual

HULL NUMBER	OWNER NAME	PHONE NO.
-------------	------------	-----------

SERVICE DATE	WORK ORDER #	BOAT COLOR	SERVICE TECHNICIAN
--------------	--------------	------------	--------------------

INSTRUCTIONS

Please complete following: check each item as completed.

1. Inspect prop
2. Check engine alignment, motor mounts, and jam nuts
3. Check shaft packing
4. Service rudder (lubrication)
5. Check battery, battery hold down, cable connections
6. Check instrumentation
7. Check lights (bow, stern, and dash)
8. Check steering wheel cable fasteners, lubricate support tube and cable
9. Check control mechanism MV-2, MV-3 (freedom of movement)
10. Check neutral safety switch operation
11. Check security of fasteners (seat slides, seats, platform, interior handles)
12. Check all fuel connections (engine, tank, pump, filter)
13. Check engine exhaust clamps
14. Change engine oil and filter
15. Change transmission fluid/ filter
16. Change V-Drive oil (clean screens / magnetic plugs)
17. Inspect belts
18. Inspect impeller
19. Clean / change flame arrestor
20. Check engine coolant (closed cooling only)
21. Check trailer: wheel lugs, lights, and loading bar
22. Inspect and lubricate wheel bearings
23. Check brake fluid level (if applicable)

LAKE TEST

1. Perform Diacom data list scan
2. Check PROM ID and record in customer file
3. Check fuel pressure and log reading
4. Verify oil levels (engine, Trans, V-Drive)
5. Verify blower operation, check hose attachment
6. Verify bilge pump operation and float control
7. Check for engine / boat water leaks
8. RE-check fuel connections
9. Verify neutral safety switch operation
10. Check for presence of vibration
11. Verify instruments operate properly
12. Verify controls operate properly (IE; steering, shifter)
13. Verify options function properly (IE; heater, shower etc.)

I certify that all checks have been performed and completed, this vessel has been prepared in conjunction with Malibu Boats specifications.
To ensure proper warranty status, Boat/ Engine MUST receive recommended maintenance schedule.

Technician Signature _____ Date _____

Service Contact _____ Phone _____

Customer Signature _____
PLEASE RETAIN IN CUSTOMER FILE FOR FUTURE REFERENCE

MALIBU BOATS LIMITED WARRANTY

Thank you for choosing to purchase a Malibu Boats, LLC (“Malibu Boats”) product. Malibu Boats is committed to assuring your satisfaction with your new boat. Malibu Boats will provide for repairs to your boat during the applicable warranty periods in accordance with the following terms, conditions and limitations.

Warranty Coverage - Summary

The warranty coverages are summarized below. Please refer to the warranty details that follow for complete terms, conditions, and limitations.

Malibu Boats Limited Warranty		
Coverage Type	Coverage Period	Transferable
Base Limited Warranty	36 Months	Yes
Tower Structural Limited Warranty	36 Months	Yes
Tower Cosmetic Limited Warranty	12 Months	No
Gelcoat Limited Warranty	24 Months	No
Hull Limited Warranty	Lifetime	Yes

In addition to the Malibu Limited Warranty, your boat also comes with other limited warranties provided by the engine and trailer manufacturers, among other items. Please refer to their limited warranty disclosures for details, including their terms, conditions and limitations.

Limitations and Disclaimer of Implied Warranties

ANY IMPLIED WARRANTY THAT IS FOUND TO ARISE BY STATE OR FEDERAL LAW, INCLUDING ANY IMPLIED WARRANTY OF MERCHANTABILITY OR ANY IMPLIED WARRANTY OF FITNESS, IS LIMITED IN DURATION TO THE DURATION SET FORTH IN THIS LIMITED WARRANTY OR THE DURATION SET FORTH BY APPLICABLE STATE OR FEDERAL LAW, WHICHEVER IS SHORTER. MALIBU BOATS DISCLAIMS ANY IMPLIED WARRANTIES, INCLUDING ANY IMPLIED WARRANTY OF MERCHANTABILITY OR ANY IMPLIED WARRANTY OF FITNESS, AFTER EXPIRATION OF THE WARRANTY PERIOD.

PERFORMANCE OF REPAIRS AND NEEDED ADJUSTMENTS IS THE EXCLUSIVE REMEDY UNDER THIS WRITTEN WARRANTY OR ANY IMPLIED WARRANTY. MALIBU BOATS SHALL NOT BE LIABLE FOR INCIDENTAL OR CONSEQUENTIAL DAMAGES, SUCH AS, BUT NOT LIMITED TO, LOST WAGES, SLIP FEES, TRANSPORTATION TO OR FROM REPAIR, OR RENTAL EXPENSES, RESULTING FROM BREACH OF THIS WRITTEN WARRANTY OR ANY IMPLIED WARRANTY.

Some states do not allow limitations on how long an implied warranty lasts or the exclusion of incidental or consequential damages, so the above limitation or exclusion may not apply to you.

Who Is Covered Under the Malibu Boats Limited Warranty

Subject to all other terms, conditions, and limitations, 1) original owners of the boat and, 2) second owners of the boat, who purchase the boat within three (3) years of the earlier of (a) the date the boat was purchased by the first retail purchaser through an authorized Malibu Boats sales facility, or (b) the date the boat was first put into service as a demonstrator or otherwise, and qualify for and complete a warranty transfer as explained below, are provided coverage under the Malibu Boats Limited Warranty.*

* The Tower Cosmetic Limited Warranty and the Gelcoat Limited Warranty are Not Transferable.

For the second owner who desires to qualify for and complete a warranty transfer, contact a Malibu Boats authorized sales facility for details. To be effective, warranty transfers must be completed within ten (10) days of the transfer of title to the boat. To complete the warranty transfer, the second owner must do the following:

- The second owner must arrange for a Malibu Boats authorized sales facility to inspect the boat, at the second owner's expense.
- At the time of such inspection, the second owner must complete a warranty transfer form (available from the authorized sales facility).

- If the boat passes the inspection, the second owner must (i) provide the completed warranty transfer form to the authorized sales facility and (ii) provide the \$500 transfer fee to the authorized sales facility (in addition to any charges such facility may have for their inspection services). The Malibu Boats authorized sales facility shall promptly provide to Malibu Boats the inspection form, the warranty transfer form and the \$500 transfer fee.

No warranty transfer shall be effective until the warranty transfer form and accompanying documents are received by Malibu Boats. No warranty transfer shall serve to expand the coverage of, extend the duration of or create any new rights under the Malibu Boats Limited Warranty beyond that which were available to the boat's original owner. Malibu Boats retains the right to deny warranty transfers to boats that are damaged or have been abused.

This Malibu Boats Limited Warranty does not provide coverage for owners of boats manufactured in the United States by Malibu Boats, LLC and imported into Australia or New Zealand. This Malibu Boats Limited Warranty does not provide coverage to any boat purchased from a dealer in another country, where the primary use of the boat will require the boat to cross an international border.

What "Is" Covered by the Malibu Boats Limited Warranty

Coverages:

Base Limited Warranty

For a period of thirty-six (36) months beginning on the date the boat is purchased by the first retail purchaser through an authorized Malibu Boats sales facility, or, beginning on the date the boat was first put into service as a demonstrator or otherwise, whichever is earlier, Malibu Boats will repair substantial manufacturing defects related to materials or workmanship supplied by it during construction of the boat.

Tower Structural Limited Warranty

For a period of thirty-six (36) months beginning on the date the boat is purchased by the first retail purchaser through an authorized Malibu Boats sales facility, or, beginning on the date the boat was first put into service as a demonstrator or otherwise, whichever is earlier, Malibu Boats will repair substantial manufacturing defects related to structural materials or structural workmanship supplied by it during construction and installation of the boat's tower.

Tower Cosmetic Limited Warranty

For a period of twelve (12) months beginning on the date the boat is purchased by the first retail purchaser through an authorized Malibu Boats sales facility, or, beginning on the date the boat was first put into service as a demonstrator or otherwise, whichever is earlier, Malibu Boats will repair substantial manufacturing defects related to cosmetic materials or cosmetic workmanship supplied by it during construction and installation of the boat's tower.

The Tower Cosmetic Limited Warranty is Not Transferable.

Towers are configured with shocks to help stabilize the tower when the tower knobs/bolts are removed for lowering the tower.

Appropriate care must be taken to ensure the tower is not allowed to fall.

Towers are configured from the factory with shocks based on the factory-installed components. If ANY additional components are mounted to the tower after the boat leaves the factory, it is the dealer and the consumer's obligation to validate that the installed shocks and the tower are rated for these additional components.

Gelcoat Limited Warranty

For a period of twenty-four (24) months beginning on the date the boat is purchased by the first retail purchaser through an authorized Malibu Boats sales facility, or, beginning on the date the boat was first put into service as a demonstrator or otherwise, whichever is earlier, Malibu Boats, conditioned on the owner having provided maintenance and care as described in the Malibu Boats Owner's Manual will repair substantial manufacturing defects related to materials or workmanship supplied by it in applying the Gelcoat finish to the boat. This Gelcoat Limited Warranty shall not include gelcoat finish, blistering, discoloration, fading or osmosis as well as damage due to in-water storage without proper barrier coat and bottom paints.

The Gelcoat Limited Warranty is Not Transferable.

Lifetime Hull Limited Warranty

For the life of the boat, Malibu Boats will repair substantial manufacturing defects related to structural materials or structural workmanship supplied by it during the construction of the hull, deck, liner, stringer or upholstery frame.

All repairs performed by Malibu Boats, or its authorized service facilities, will be performed using either new or re-manufactured parts. Malibu Boats may, at its option, install parts which have similar or greater performance characteristics if an identical replacement part is no longer available. Repairs will be warranted only for the remainder of the original warranty period.

In addition to Malibu Boats Limited Warranty, your boat also comes with other limited warranties provided by the engine and trailer manufacturers, among other items. Please refer to their limited warranty disclosures for details, including their terms, conditions and limitations.

What "Is Not" Covered by the Malibu Boats Limited Warranty

The following are **NOT** covered under the Malibu Boats Limited Warranty:

- Normal maintenance of boat, or any component thereof
- Normal wear and tear of boat, or any component thereof
- Damages caused by defects in materials, components or parts not supplied by Malibu Boats

-
- Damages or needed adjustments caused by items that are added, altered or changed after the boat leaves the possession of Malibu Boats, such as installation of aftermarket towers, tower accessories, ballast systems, barefoot booms, canvas accessories, and bottom painting
 - Damages caused by accident (including impacts and collisions with any object), abuse, misuse, neglect, mishandling or alteration, including any damages caused by or during trailering or towing
 - Damages caused by heat, fire, explosion or freezing (including the failure to perform proper winterization)
 - Damages caused by the installation of non-Malibu Boat materials, components or parts
 - Damages caused by lightning, hail, rain, flooding, wind, sand, floods or other environmental or natural conditions
 - Damages caused by atmospheric fallout, chemical treatments, tree sap, salt, ocean spray, mold, or animal droppings
 - Corrosion, oxidation, electrolysis including chrome plated, anodized or aluminum finish or colorfastness of finish (Exposure to a salt or brackish water environment can cause corrosion, or damage. Failure to rinse thoroughly after each use and apply a protective coating will void warranty.)
 - Damages caused by aftermarket cleaning products or non-Malibu approved additives
 - Damages due to insufficient or improper maintenance, including use of oils, lubricants or fluids other than those recommended in the boat's Owner's Manual
 - Conditions resulting from normal wear and tear
 - Conditions resulting from use of the boat for anything other than recreational purposes
 - Manufacturing variations or imperfections in cosmetic, convenience or aesthetic components or features of the boat, including the gelcoat finish, which have no effect on use, value or safety. Because the gelcoat finish is applied manually by a Malibu Boats craftsman, minor distortions or imperfections may be found in certain areas of the boat. Such distortions and imperfections are considered normal.
 - Damages caused by the use of any trailer not sold through Malibu Boats
 - Damages caused by improper support of the boat on davits, hoist system or boat lift of any kind
 - Damages caused by overloading or overpowering the boat
 - Any material, component or part of the boat that is covered by a warranty supplied by another entity
 - Damages caused by water intrusion into any part of the boat (including the glove box)
 - Gelcoat finish, blistering, discoloration, fading or osmosis as well as damage due to in-water storage without proper barrier coat and bottom paints (NOTE: Although Malibu Boats uses the highest-grade gel coat materials, a condition may develop where the bottom of the boat may show signs of discoloration and/or blisters if the boat is left in the water for long periods of time; therefore, a proper barrier coat and bottom paint should be used whenever it is anticipated that the boat will be left in the water for an extended period of time)
 - Performance characteristics, such as speed, acceleration, fuel or oil consumption, etc., as they are estimated and can vary under numerous conditions
 - Any and all consequential damages including, but not limited to, costs incurred for haul-out, launching, towing, and storage charges, telephone, expedited shipping of replacement parts, or rental charges of any type (including slip fees), inconveniences, or loss of time or income
-

- Components such as Surf Gates™, Fins, Wedges must not be added on any boat that is not equipped with those components at the time of manufacture. Installation of any of these items, or any other component not installed at the time of manufacture, will void the warranty and other components of the boat that have their own warranty(ies) due to potential damage to the boat and its occupants
- Damage to the boat, the trailer, or anything / anyone else caused by any trailer is not covered under the Malibu Warranty(ies). Malibu Boats does not work with any trailer manufacturer other than Boatmate™ to allow for trailers to be fitted to the boat at the time of manufacture. Malibu specifically disavows any and all responsibilities for any trailer

The following events will discharge Malibu Boats from its obligations under the Malibu Boats Limited Warranty:

- Unauthorized disconnection, tampering with, or altering of the boat's hour meter
- Unauthorized disabling of any Malibu Boats' installed warning device or system
- Unauthorized disconnection, disturbance or compromise of any wires, hoses, tubes, cables, looms or other components of the boat's electrical or fuel systems
- Determination by any state or federal entity or private insurance carrier that the boat is a total loss or fit only for salvage

This Malibu Boats Limited Warranty does not provide coverage to any boat which has ever been: (a) a repossession from a retail customer; (b) purchased at auction (bank auction, online auction, auction house, etc.); (c) purchased from a salvage yard; (d) purchased from an insurance company that obtained the product as a result of an insurance claim.

The Malibu Boats Limited Warranty does not cover the costs of maintenance, which include, but are not limited to, boat inspections, lubrication, engine tune-ups, replacement of filters, coolants, spark plugs, bulbs, fuses, impellers, packing materials, cleaning and polishing.

No oral or written information, advice or communication of any nature by or from Malibu Boats or its representatives, employees, dealers, agents, distributors or suppliers shall create a warranty or in any manner increase or modify the scope of this Malibu Boats Limited Warranty in any manner whatsoever.

This Malibu Boats Limited Warranty is expressly conditioned upon the timely completion and return of the warranty registration card to Malibu Boats.

How to Get Warranty Service

To obtain warranty service and/or repairs, you must do all of the following:

1. Notify Malibu Boats or an authorized Malibu Boats service facility of the substantial defect in materials or workmanship attributable to Malibu Boats, within thirty (30) days of discovery of the defect; and,

-
2. Promptly schedule an appointment with and deliver your boat to Malibu Boats or an authorized Malibu Boats service facility for repairs. Warranty service must be performed by Malibu Boats or an authorized Malibu Boats dealer. While not required, it is preferable that you deliver your boat to your selling sales and service facility. If you need assistance locating an authorized Malibu Boats service facility, please visit Malibu Boats website at www.malibuboats.com or call Malibu Boats at (865) 458-7110.

Please note that Malibu Boats authorized repair facilities, generally, are independently owned and operated businesses. Malibu Boats does not control the scheduling of service work. However, if you encounter any material delays in obtaining service at one of Malibu Boats authorized service facilities, please call Malibu Boats for assistance at (865) 458-7110.

Important Additional Things to Know about the Malibu Boats Limited Warranty

In addition to the warranty terms and exclusions noted above, below you will find some additional important things to know about the Malibu Boats Limited Warranty:

Boat Operation, Care and Maintenance

To ensure that you receive the maximum benefit from your purchase and this limited warranty, Malibu Boats strongly recommends that you follow all of the instructions in the boat's operating manuals, including if applicable, any accompanying maintenance or service schedules. Because questions may sometimes arise relating to the cause of a particular failure, Malibu Boats strongly recommends that you keep detailed records of any maintenance or service performed on your boat so that you may be able to assist, if necessary, in the determination of whether a failure is covered under this Limited Warranty. Damages to your boat caused by improper operation, care and maintenance are not covered by the Malibu Boats Limited Warranty.

Malibu offers gray boat covers for which the Limited Warranty is administered by their manufacturer. No other color is offered by Malibu, and if another color is used, the cover and upholstery warranty will be voided.

Pre-Delivery Service

Defects and/or damage to the finish surfaces, trim, upholstery or other observable cosmetic components of your boat may occur at the factory. These items are usually detected and corrected at the factory or by the selling dealer prior to delivery to the retail customer. You are encouraged to inspect your boat for this type of damage when you take delivery. If you find any such defects or damage you must notify the selling Malibu Boats dealer at the time of delivery to have these items covered by this limited warranty and to have work performed on the items at no cost to you.

Design and/or Manufacturing Changes

Malibu Boats reserve the right to make changes in boats built by it at any time without incurring any obligation to make the same or similar changes on boats previously built and/or sold.

Other Warranties

Some materials, components or parts of the boat which are NOT covered by the Malibu Boats Limited Warranty are separately warranted by their manufacturers or suppliers. These other warranties include, but are not limited to, warranties covering the engine, audio system, trailer, tires, mooring covers, batteries and Bimini tops. See copies of these other warranties for details relating to their terms, conditions and limitations.

Customer Satisfaction Procedure

Satisfaction with your boat is very important to Malibu Boats. Ordinarily all concerns related to your boat can be addressed by your authorized Malibu Boats service facility. If for some reason your concerns are not satisfied, the following steps should be followed:

First, ask to discuss your concern with a member of the authorized service facility's management. Ordinarily this will be the facility's service manager or service foreman. If your concerns already have been reviewed by the service manager or foreman, request to speak with the facility's general manager or owner.

Second, if your concerns are not resolved to your satisfaction by the representatives of the service facility, contact Malibu Boats' Customer Service Department at the address noted below. For the most helpful service, be prepared to provide your customer service representative with your name, address and phone number, your boat's hull identification number, the authorized Malibu Boats service facility or facilities at which your boat has been serviced, and the nature of the concerns you have with the boat or the service. Malibu Boats will thereafter provide assistance to you and the authorized service facility, as necessary, to resolve your concerns.

TO THE EXTENT PERMITTED OR REQUIRED BY ANY STATE OR FEDERAL LAW, YOU ARE REQUIRED TO PROVIDE MALIBU BOATS WRITTEN NOTICE, AT THE BELOW ADDRESS, OF ANY SUBSTANTIAL DEFECT IN MATERIALS OR WORKMANSHIP THAT REMAINS UNRESOLVED TO YOUR SATISFACTION UNDER THE TERMS OF THE MALIBU BOATS LIMITED WARRANTY, PRIOR TO INITIATING ANY LEGAL ACTION AGAINST MALIBU BOATS. TO THE EXTENT PERMITTED OR REQUIRED BY ANY STATE OR FEDERAL LAW, YOU MUST FIRST USE AN AVAILABLE STATE RUN INDEPENDENT DISPUTE SETTLEMENT MECHANISM OR ARBITRATION MECHANISM PRIOR TO INITIATING ANY LEGAL ACTION AGAINST MALIBU BOATS.

Contact Information:

Malibu Boats
 5075 Kimberly Way
 Loudon, TN 37774
 (865) 458-5478

Malibu Boats, LLC Internet Site
www.malibuboats.com

THIS WARRANTY GIVES YOU SPECIFIC LEGAL RIGHTS, AND YOU MAY ALSO HAVE OTHER LEGAL RIGHTS WHICH VARY FROM STATE TO STATE

Malibu Commercial Use Warranty

In the event your boat is used for commercial use, then the standard implied warranties do not apply and Malibu Boats, LLC completely disclaims them to the extent allowed by law. The Implied warranty of fitness for a particular purpose does not apply if your boat is used for exhibition, even if the boat is equipped for that purpose.

Commercially used boat will have the following warranty:

Malibu Boats Commercial Limited Warranty

Coverage Type	Coverage Period	Transferable
Base Limited Warranty	6 months	no
Tower Structural Limited Warranty	6 months	no
Tower Cosmetic Limited Warranty	3 months	no
Gelcoat Limited Warranty	3 months	no
Hull Limited Warranty	5 years	no

Attwood Fuel System Two-Year Warranty and Liability

Generally: All Attwood Fuel System Components are covered by a two (2) year limited warranty from the date of a Vessel's first retail sale.

Pre-requisites to Warranty Eligibility: For the warranty coverage described herein to apply, the following conditions must be met:

- Component must have been properly installed per Attwood installation instructions; and
- The component cannot have been altered or abused by Boat Company or its customers.

Warranty Terms for Components:

Attwood warrants that any Attwood Fuel System Components are free from defects in materials and workmanship and are designed, built, and equipped to conform at the time of sale to Boat Company with the 40CFR.1060 requirements. For two (2) years from the date of a Program Boat's first retail sale, Attwood will, at its sole option, repair or replace any components that fail due to a defect in material or workmanship. ATTWOOD PROVIDES NO WARRANTIES WITH RESPECT TO ANY PART OR COMPONENT NOT MANUFACTURED BY ATTWOOD, INCLUDING FUEL TANKS. Boat Company is responsible for the installation of all Systems, whether installed by Boat Company or under its direction.